



CATÁLOGO

**PERFIS DE
ALUMÍNIO**

2026

Abril

QUEM SOMOS

A Vitral Sul é uma empresa que atua no ramo vidreiro à 30 anos em todo território brasileiro.

Contamos com uma ampla variedade de produtos, qualidade e bom atendimento.

Nossos produtos diferenciados atraem a atenção dos mais variados setores: Vidraçaria, Metalúrgicas, Indústrias Moveleiras, Construção Civil, Arquitetos e Decoradores.

Para acompanhar as principais tendências do mercado, contamos com a parceria dos melhores fabricantes do setor, sempre buscando atender cada vez melhor os nossos clientes.

Sempre em alerta as novidades de mercado, a Vitral Sul é uma das maiores e mais modernas empresas no ramo vidreiro.

Possuímos mais de 15.000 produtos a pronta entrega, e um estoque informatizado e atualizado, possibilitando que nossa frota de entrega consiga atender de maneira ágil, respeitando os prazos de entrega combinado com cada cliente.

Junte-se a nós e faça parte dessa história!



SAIBA MAIS



Esaneie o QR Code

Barra Chata	05
Cantoneiras abas iguais	06
Cantoneiras abas desiguais	06
Tubo quadrado	07
Tubo redondo	08
Tubo retangular	09
Vergalhão quadrado para espeto	10
Vergalhão redondo para espeto	10
Box Sorobox liso	11
Box Frisado	12
Box Temperado	13
Vidro Temperado 8 mm	14
Vidro Temperado 10/12 mm	17
Vidro Temperado trilhos	20
Fachada cortina	21
Perfis diversos Telas Mosquiteira / Tela Mosquiteira Recolhível	24
Perfis diversos Policarbonato	25
Perfis diversos Vitrines / Sistema Deslizante	26
Portão basculante caixa e Tampa Lateral	27
Portões	28
Lambris	30
Muxarabi (Revestimento/Decoração)	40
Gradil	45
Guarda-Corpo GradLine	50
Guarda-Corpo Autoportante	52
Conexões	53
Contramarcos e arremates	54
Correr / Veneziana / Camarão	58
Linha 25	59
Linha 30 Porta de giro	61
Linha 42 Porta de giro	63
Módulo Especial	66
Linha Nobile 2.5	67
Linha Nobile 2.5 - Suprema	72
Linha Nobile 2.5 5 Planos	75
Linha Integrada Nobile 2.5	90
Linha Integrada Nobile 2.5 3 Planos	94
Linha Integrada Nobile Quadrada	97
Linha Nobile 3.2	99
Linha 3.2 Porta de giro	119
Linha 3.2 Trilho Modular Acoplar	120
Linha Nobile 3.2 Minimalista	121
Linha Nobile 3.2 Colado	124
Sistema Chroma	129
Linha Integrada Nobile 3.2	152
Venezianas	159
Ventilação / Brise	161
Fachada Athex	162
Pele de Vidro II	170
Porta	174

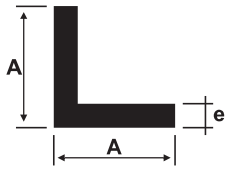

CANTONEIRAS ABAS IGUAIS

CÓDIGO PERFIL	MILÍMETROS		POLEGADAS		PESO (Kg/m)
	A	e	A	e	
CT-001	15,87	1,58	5/8	1/16	0,130
CT-002	12,70	1,58	1/2	1/16	0,103
CT-004	19,05	1,30	3/4	—	0,129
CT-005	25,40	1,30	1	—	0,175
CT-008	50	1,50	2	1.1/16	0,490
CT-009	50,80	3,17	2	1/8	0,841
CT-038	38,10	1,59	1.1/2	1/16	0,320

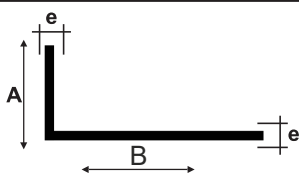

CANTONEIRAS ABAS DESIGUAIS

CÓDIGO PERFIL	MILÍMETROS		ESPESSURA		PESO (Kg/m)
	A	B	A / e	B / e	
CT-012	12,70	25,40	3,17	3,17	0,300
CT-016	16,00	40,00	1,03	1,03	0,192
CT-025	25,00	50,00	1,50	1,50	0,299



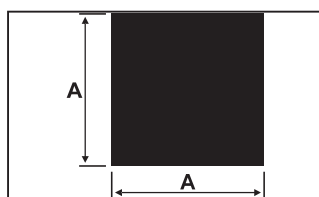

VERGALHÃO QUADRADO PARA ESPETO

CÓDIGO PERFIL	MILÍMETROS	POLEGADAS	PESO
	A	A	(Kg/m)
VQ-005	6,35	1/4	0,109

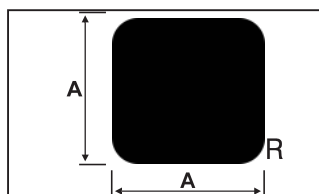

VERGALHÃO QUADRADO CANTOS ARREDONDADOS PARA ESPETO

CÓDIGO PERFIL	MILÍMETROS	POLEGADAS	RAIO	PESO
	A	A	R	(Kg/m)
VQ-501	6,35	1/4	2,00	0,109

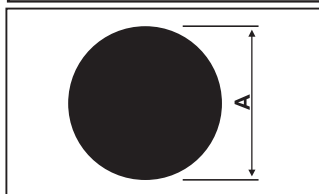

VERGALHÃO REDONDO PARA ESPETO

CÓDIGO PERFIL	MILÍMETROS	POLEGADAS	PESO
	A	A	(Kg/m)
VR-004	6,35	1/4	0 086

BOX SOROBAX

LISO

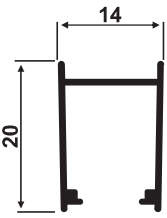
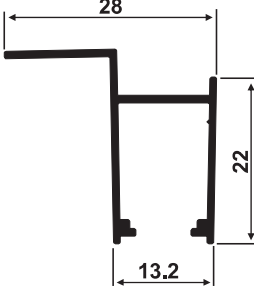
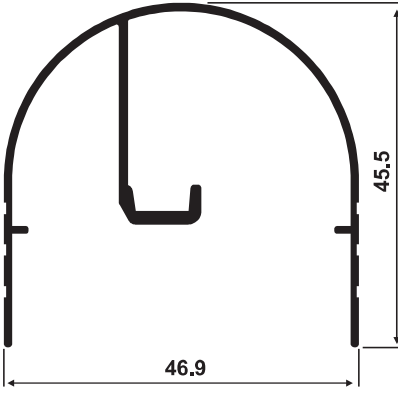
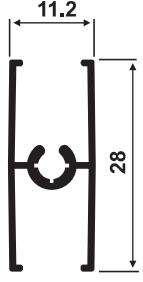
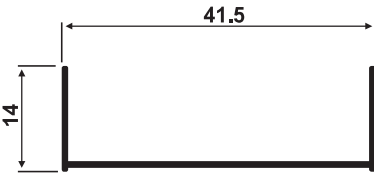
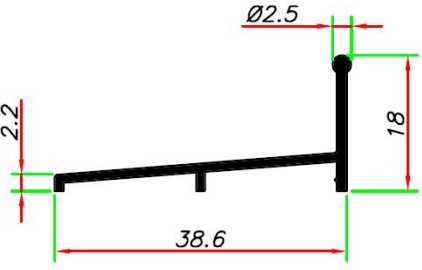
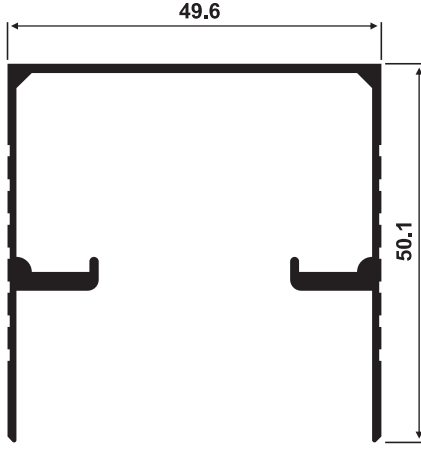

 <p>5016 0,160 Kg/m</p>	 <p>5010 0,206 Kg/m</p>	 <p>3021 0,535 Kg/m</p>
 <p>5015 0,223 Kg/m</p>	 <p>5014 0,178 Kg/m</p>	
 <p>5013 0,231 Kg/m</p>	 <p>3009 0,559 Kg/m</p>	



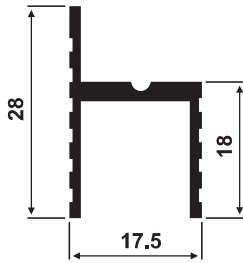

3006
0,241 Kg/m

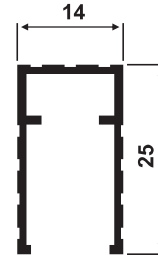

3004
0,203 Kg/m

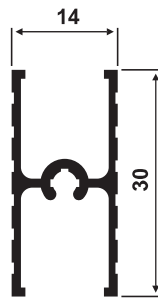

3003
0,257 Kg/m



3002
0,240 Kg/m

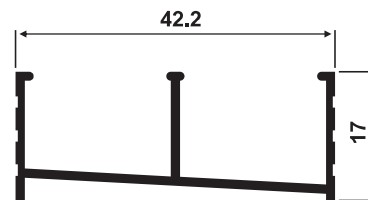

3010
0,286 Kg/m

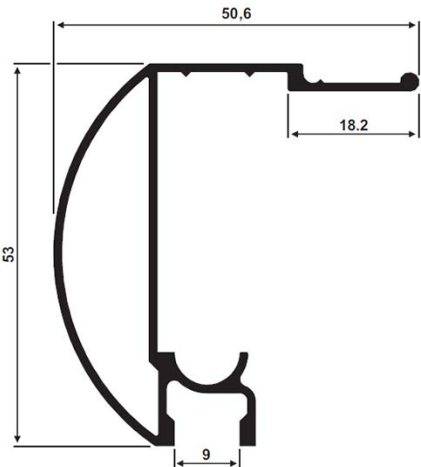
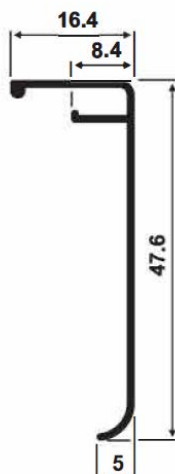
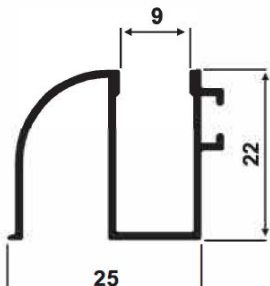
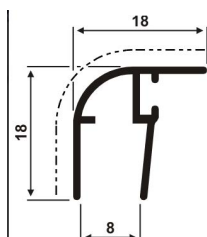

 <p>VT-60A 0,686 kg/m</p>	 <p>VT-61A 0,214 kg/m</p>
 <p>VT-62 0,269 kg/m</p>	 <p>VT-64 0,160 kg/m</p>



VIDRO TEMPERADO

8 mm

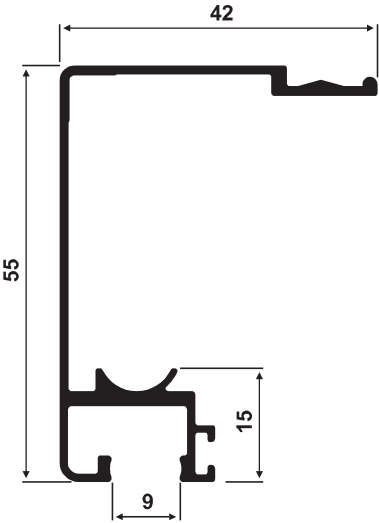
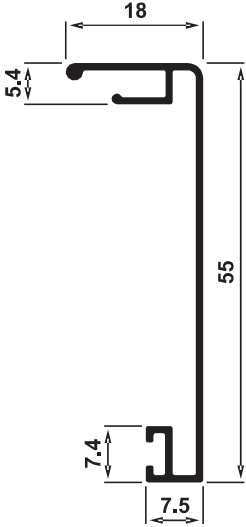
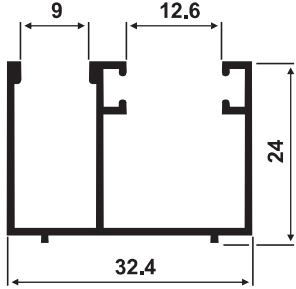
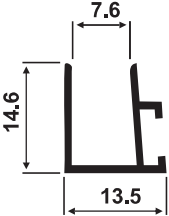
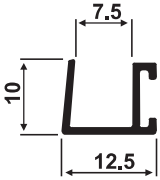
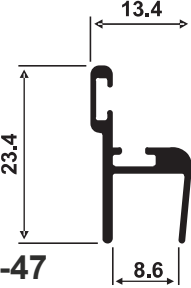
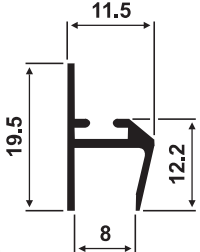
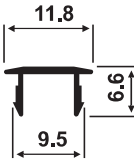
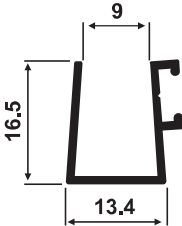
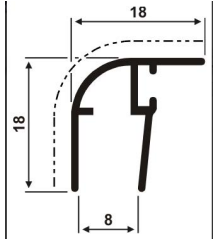

 <p>VT-49A 0,583 Kg/m</p>	 <p>VT-50A 0,282 kg/m</p>	 <p>VT-45 0,344 Kg/m</p>  <p>VT-46 0,127 Kg/m</p>
 <p>VT-16 0,098 Kg/m</p>	 <p>VT-47 0,199 kg/m</p>	 <p>VT-63 0,134 Kg/m</p>
 <p>VT-65 0,067 Kg/m</p>	 <p>VT-15 0,169 Kg/m</p>	 <p>VT-64 0,160 kg/m</p>

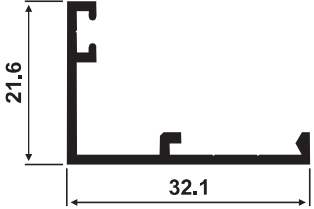
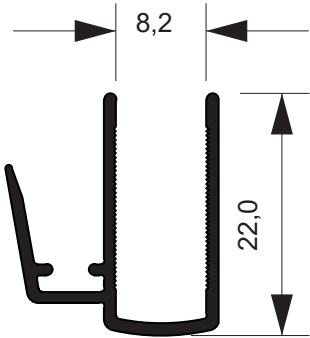
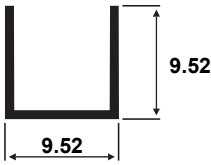
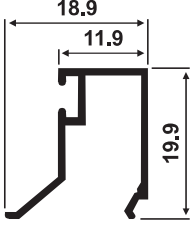
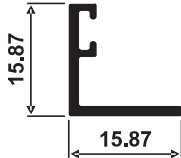
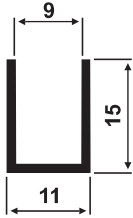
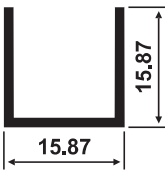
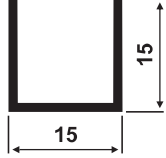
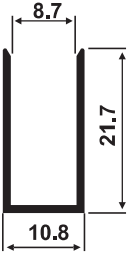
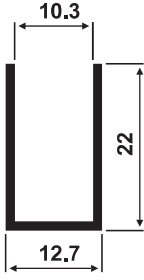
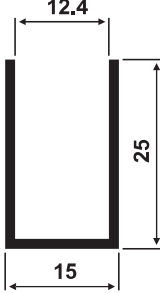
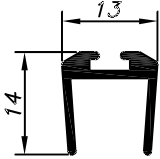

 <p>VT-26 0,244 kg/m</p>	 <p>VT-890 0,202 kg/mt</p>	
 <p>VT-09 0,073 kg/m</p>	 <p>VT-27 0,163 kg/m</p>	 <p>VT-25 0,158 kg/m</p>
 <p>VT-44 0,115 Kg/m</p>	 <p>VT-12 0,180 Kg/m</p>	 <p>VT-227 0,150 Kg/m</p>
 <p>VT-66 0,154 Kg/m</p>		
 <p>VT-806 0,185 Kg/m</p>	 <p>VT-10 0,200 Kg/m</p>	 <p>VT-22 0,173 kg/m</p>



VIDRO TEMPERADO

8 mm

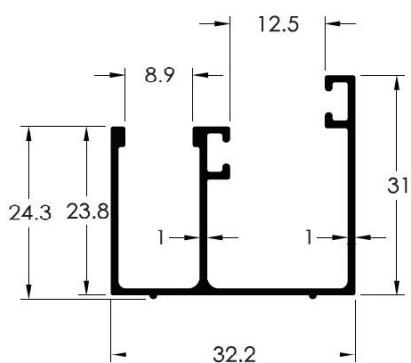

VT-140
0,356 kg/m

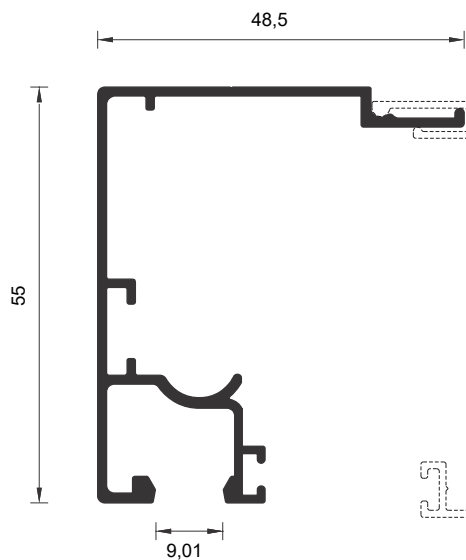

VT-58
0,569 kg/mt



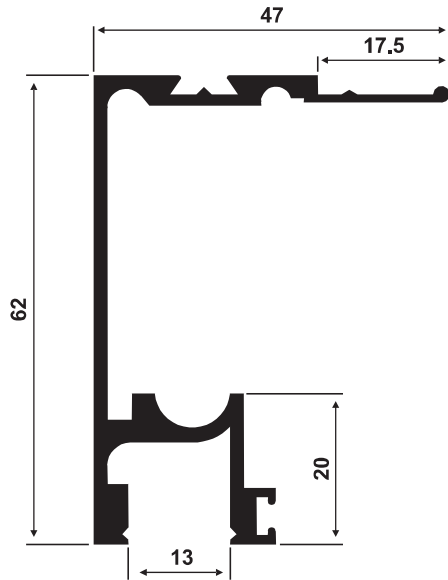

VT-01
0,990 Kg/m

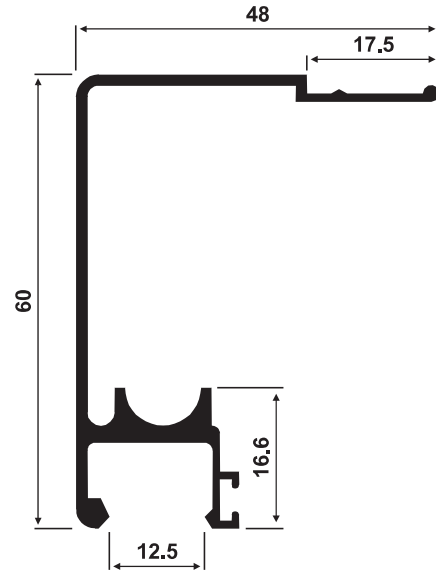

VT-51A
0,729 Kg/m

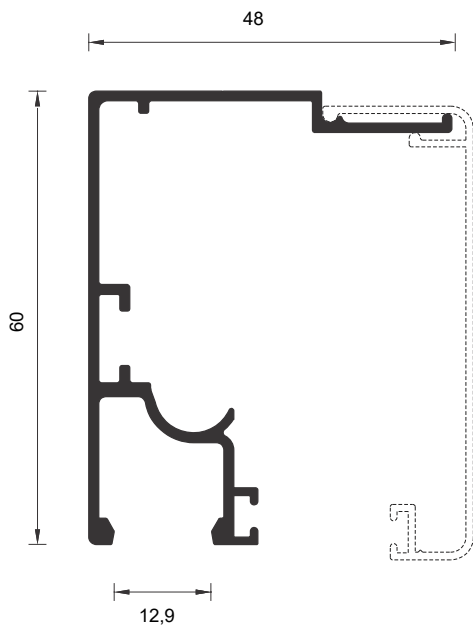

VT-59
0,621 kg/mt

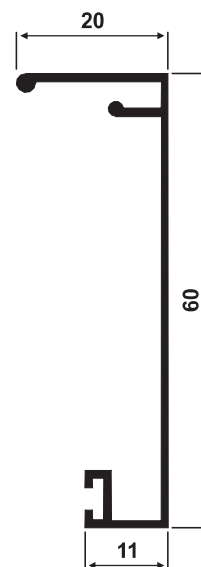

VT-52A
0,305 Kg/m



VIDRO TEMPERADO

10/12 mm

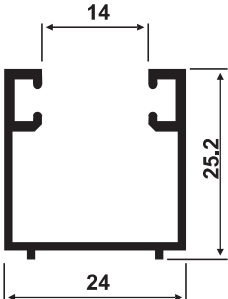
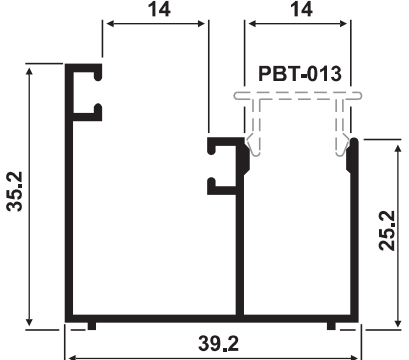
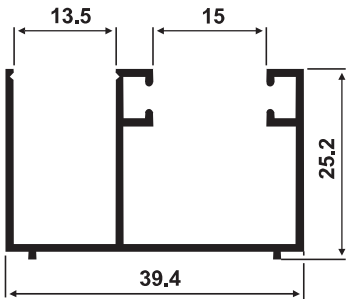
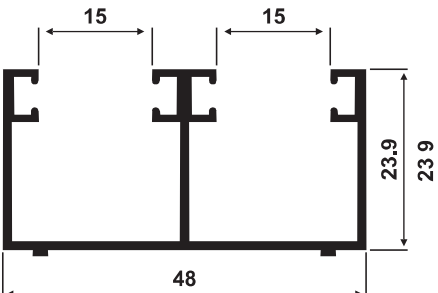
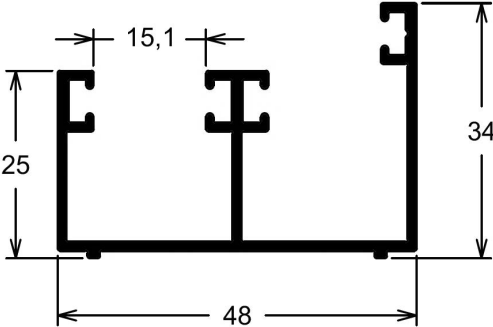
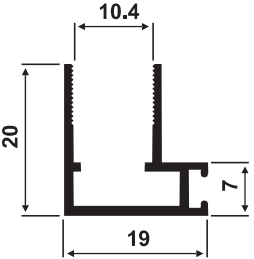
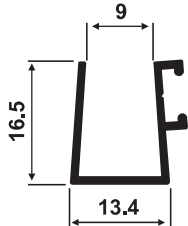
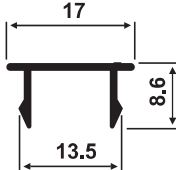

 <p>VT-06 0,293 Kg/m</p>	 <p>VT-141 0,447 Kg/m</p>	 <p>VT-05 0,390 Kg/m</p>	
 <p>VT-39 0,510 Kg/m</p>	 <p>VT-56 0,549 kg/m</p>		
 <p>VT-14 0,225 Kg/m</p>		 <p>VT-15 0,169 Kg/m</p>	 <p>VT-13 0,089 Kg/m</p>

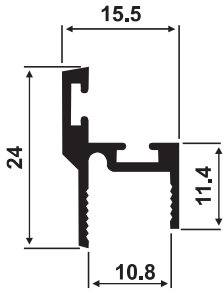
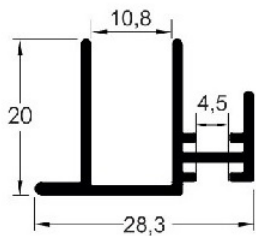
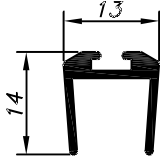
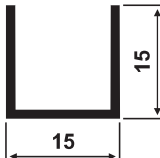
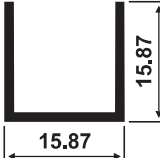
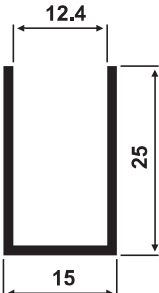
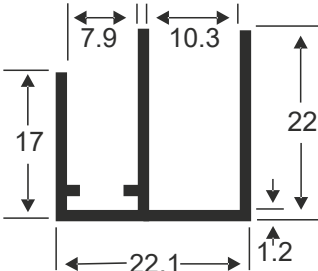
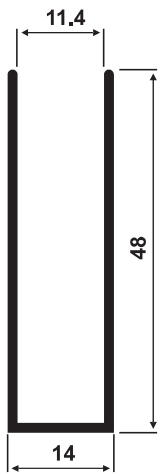

 <p>VT-17 0,225 Kg/m</p>	 <p>VT-18 0,253 Kg/m</p>	 <p>VT-22 0,173 kg/m</p>	
 <p>VT-227 0,150 Kg/m</p>	 <p>VT-12 0,180 Kg/m</p>		
 <p>VT-10 0,200 Kg/m</p>	<p>Mão Amiga</p>  <p>VT-390 0,351 kg/m</p>	 <p>VT-11 0,379 kg/m</p>	



VIDRO TEMPERADO TRILHOS

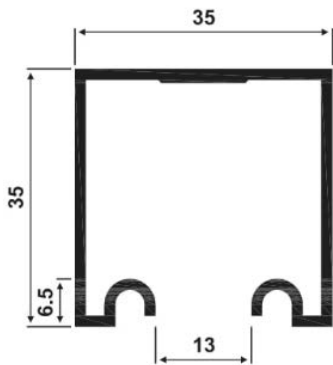

VT-35
0,508 kg/m

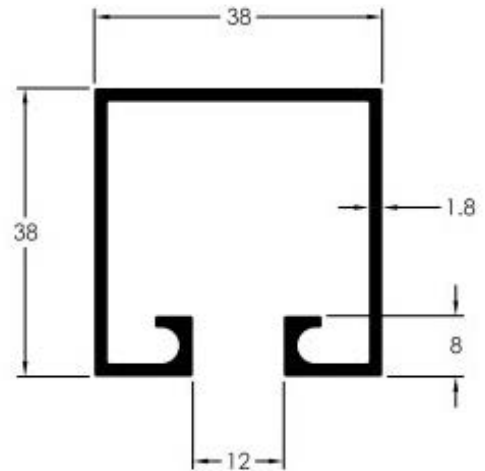

VT-037
0,676 kg/m

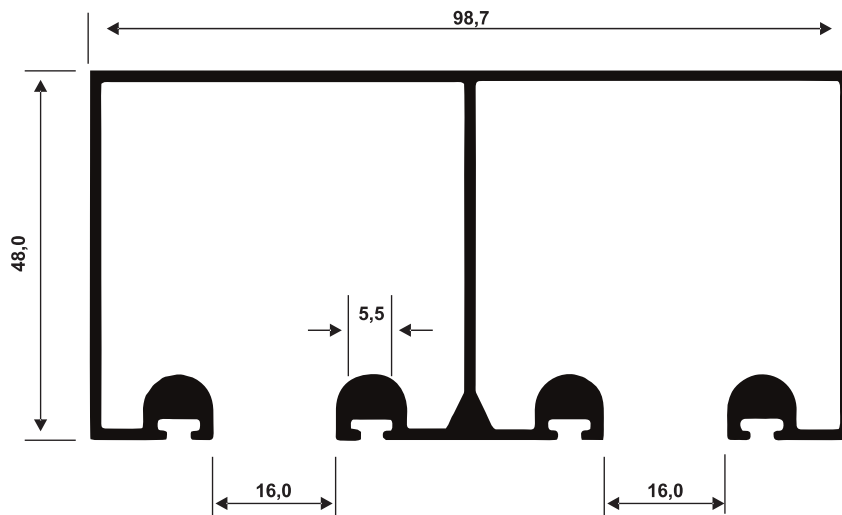

VT-268
1,654 Kg /mt

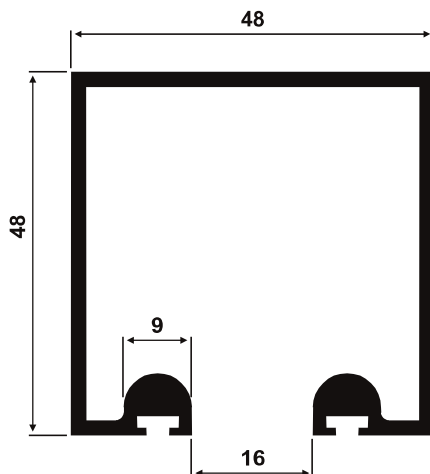

VT-68
1,150 Kg/m

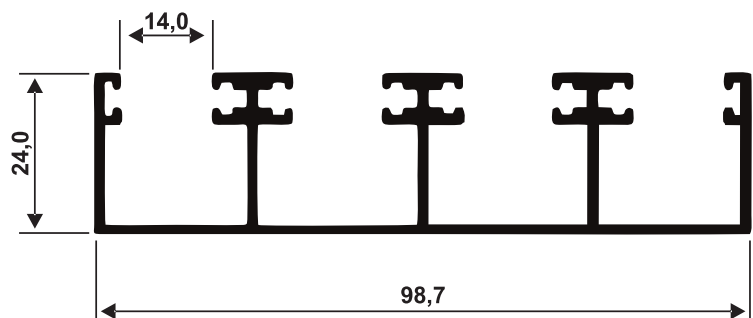

VT-239
1,003 Kg /mt

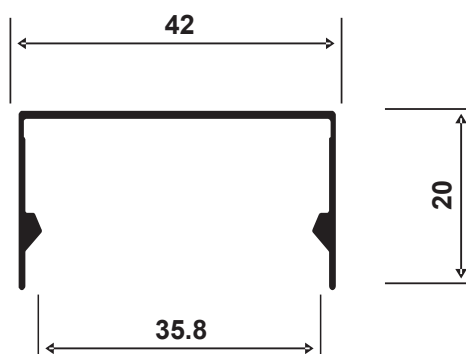

FC-034

0,249 kg/mt

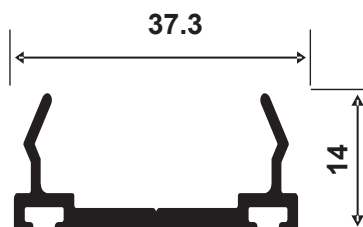

FC-035

0,375 kg/mt

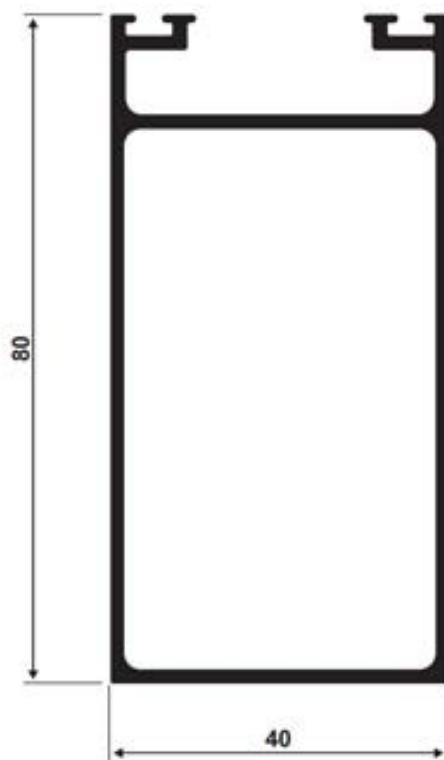

FC-036

1,233 kg/mt

FC-542
FC-542
0,350 kg/m

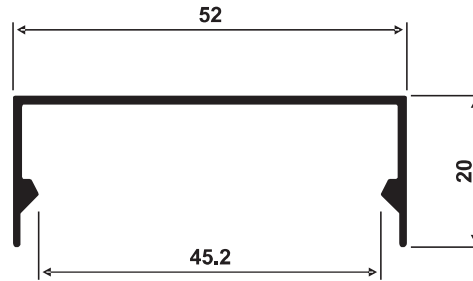

FC-543
FC-543
0,434 kg/m

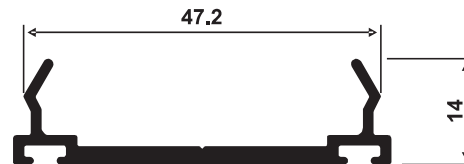

FC-017
FC-017
1,860 kg/m

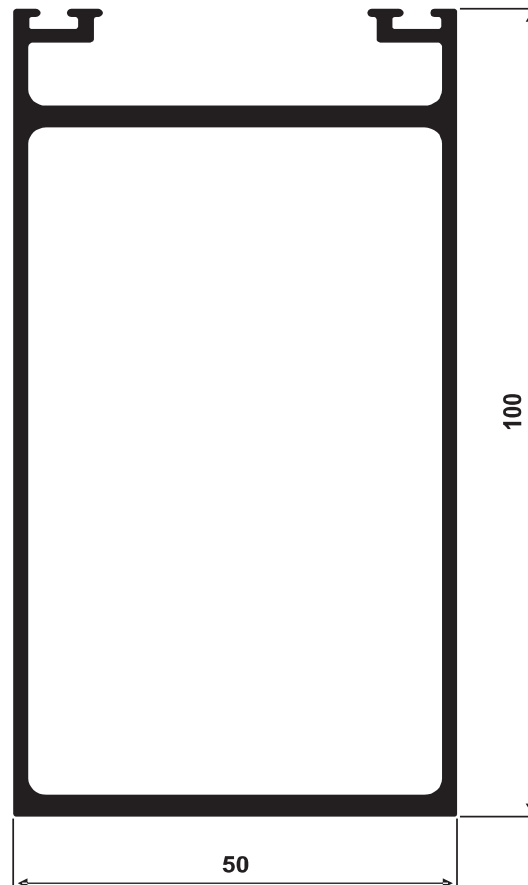

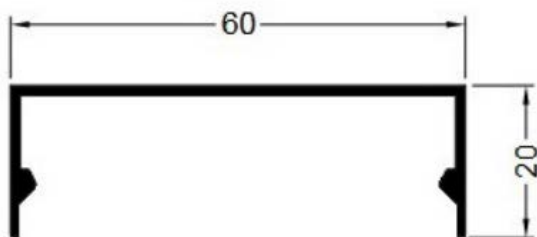

TAMPA
FC-125
0,366 kg/mt

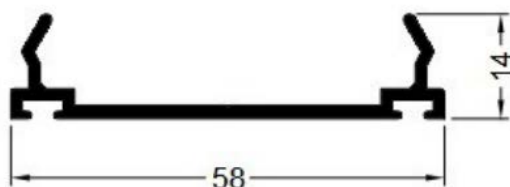

CONTRA TAMPA
FC-126
0,398 kg/mt

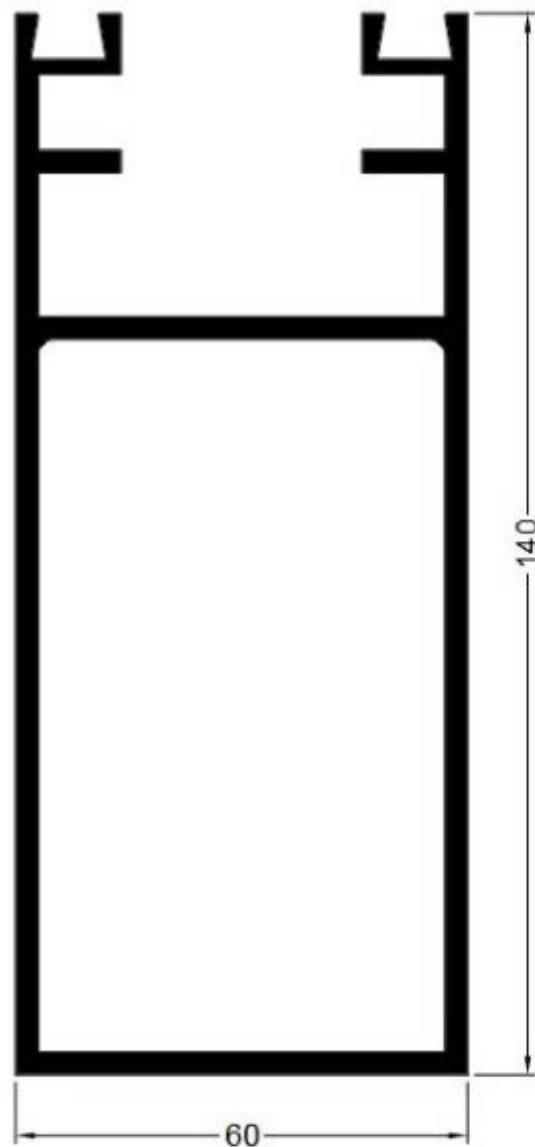

COLUNA
FC-124
3,526 kg/mt

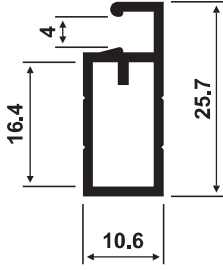
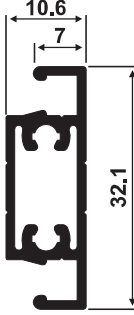
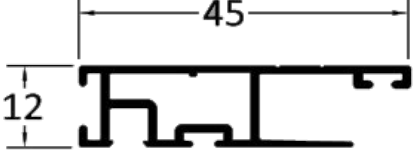

 <p>PTL-001 0,262 Kg/m</p>	 <p>PTL-002 0,320 kg/m</p>	 <p>PTL-003 0,387 kg/mt</p>
--	--	---

TELA MOSQUITEIRA RECOLHÍVEL

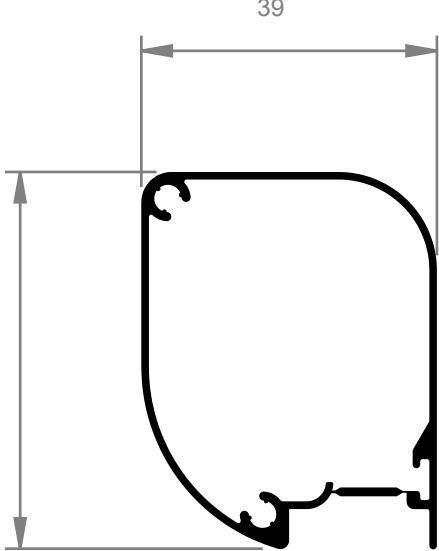
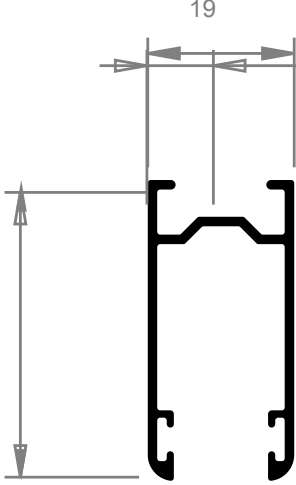
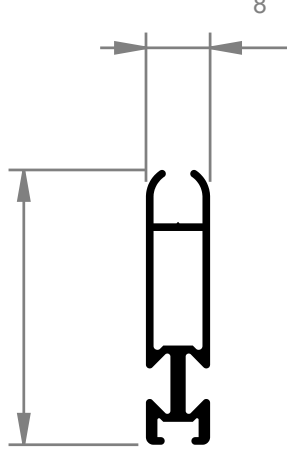
 <p>PTR-001 0,542 kg/mt</p>	 <p>PTR-002 0,375 kg/mt</p>	 <p>PTR-003 0,292 kg/mt</p>
--	---	--





PDS-1101
0,214 kg/m

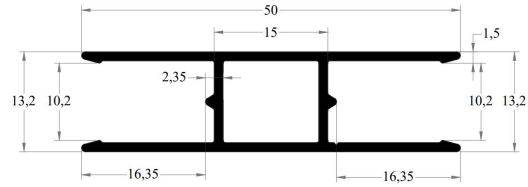

PDS-007
0,404 kg/m

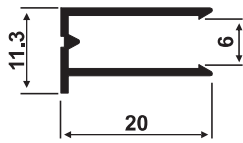

PUP-060
0,141 kg/m

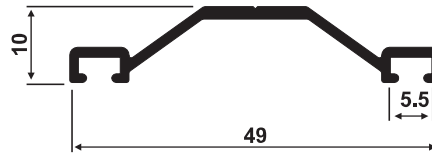

PDS-1103
0,260 kg/m



PERFIS DIVERSOS

Vitrines

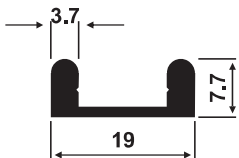
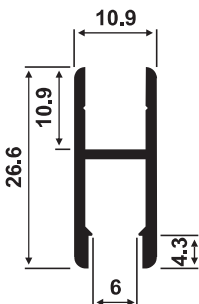
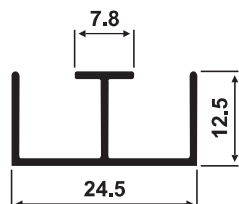

 <p>PDS-295 0,203 Kg/m</p>	 <p>PDS-025 0,269 kg/m</p>	 <p>PDS-271 0,192 Kg/m</p>
--	--	--

Sistema Deslizante

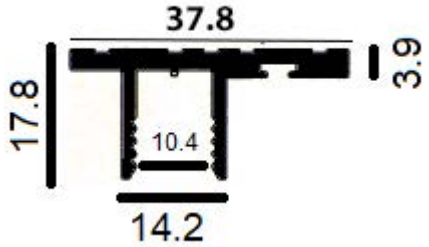
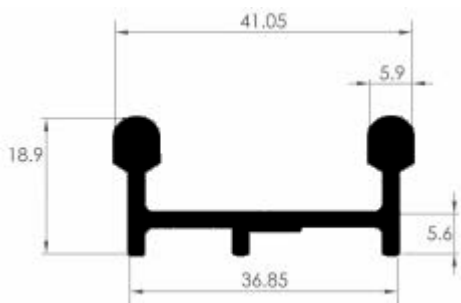
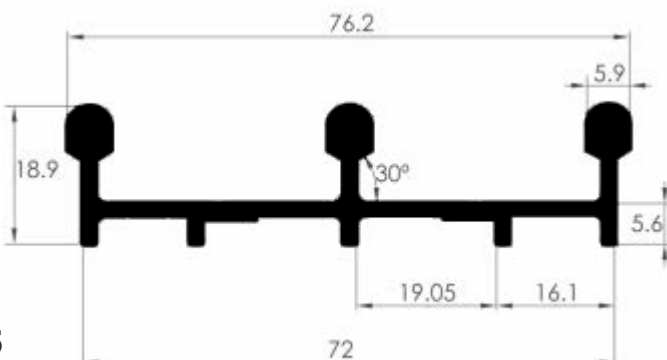
 <p>PPF0765 0,446 kg/m</p>		
 <p>ME034 0,510 kg/m</p>	 <p>ME035 0,857 kg/m</p>	



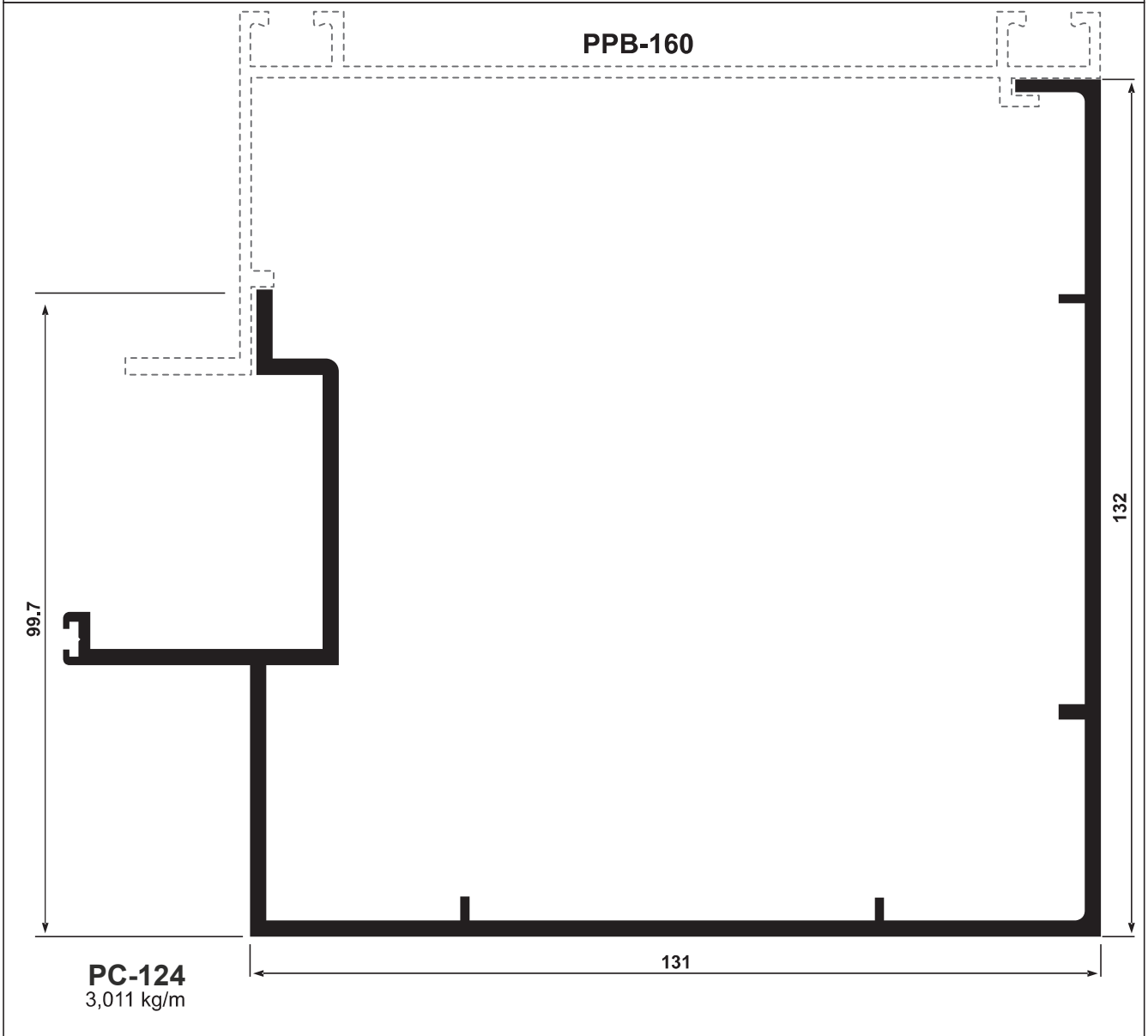
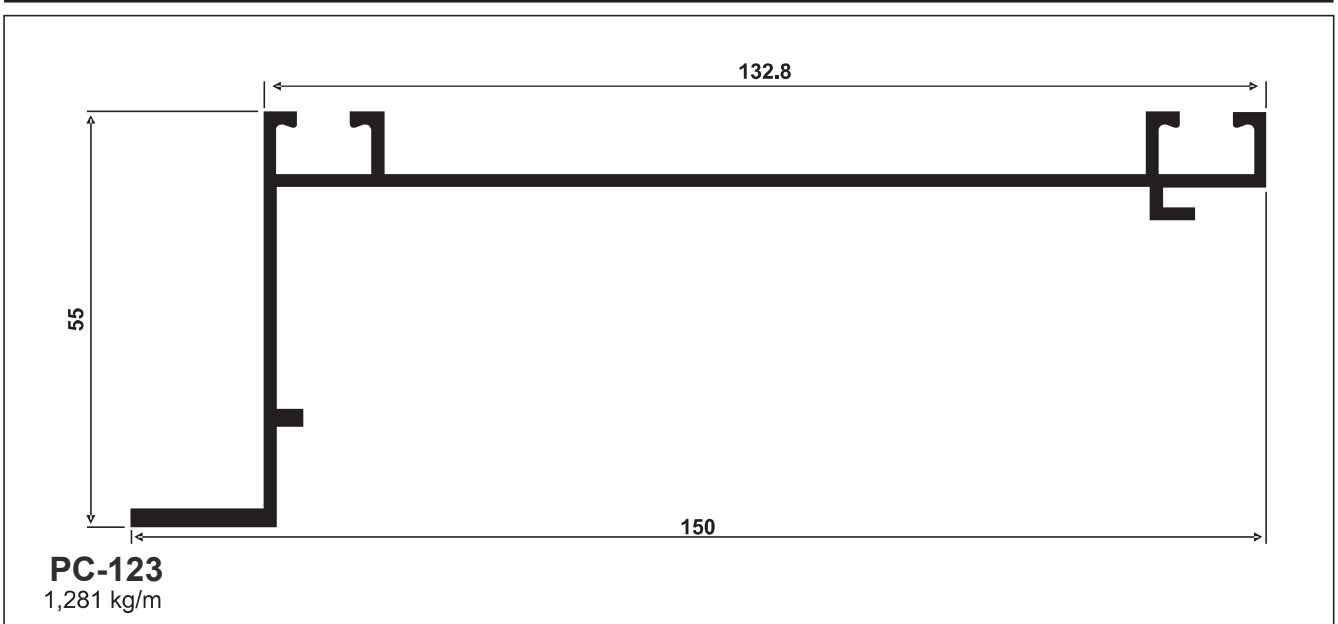

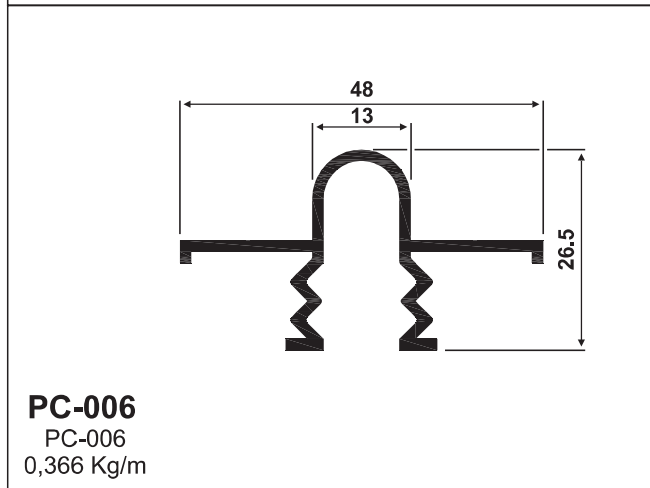
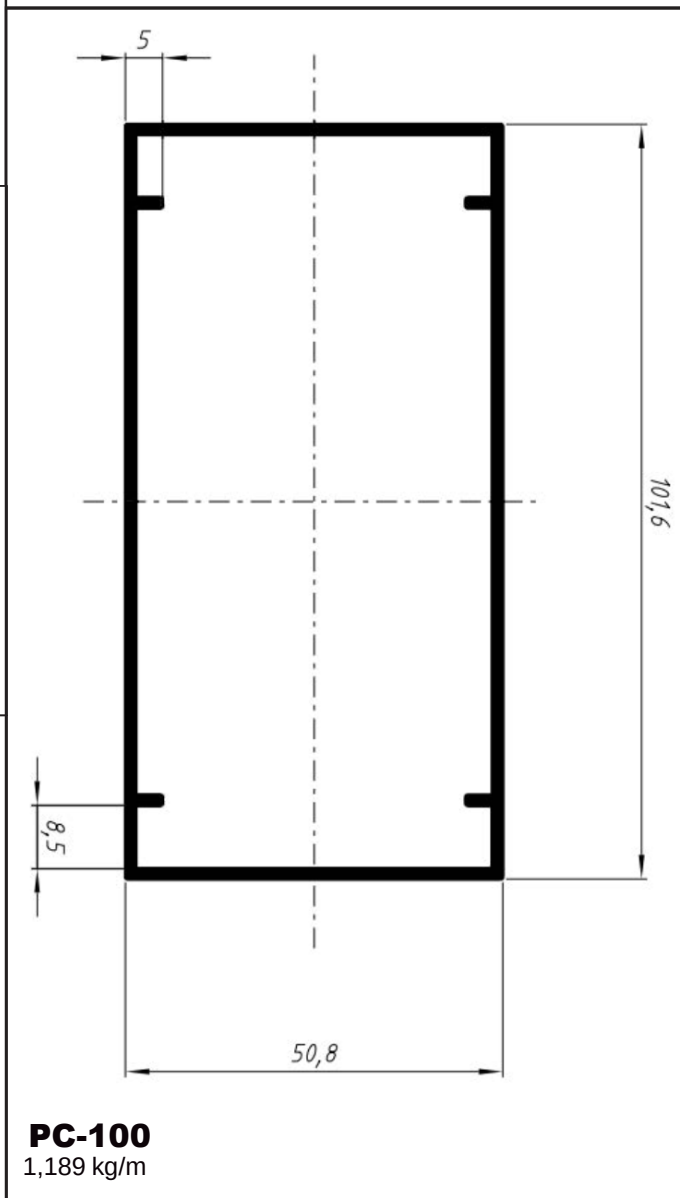
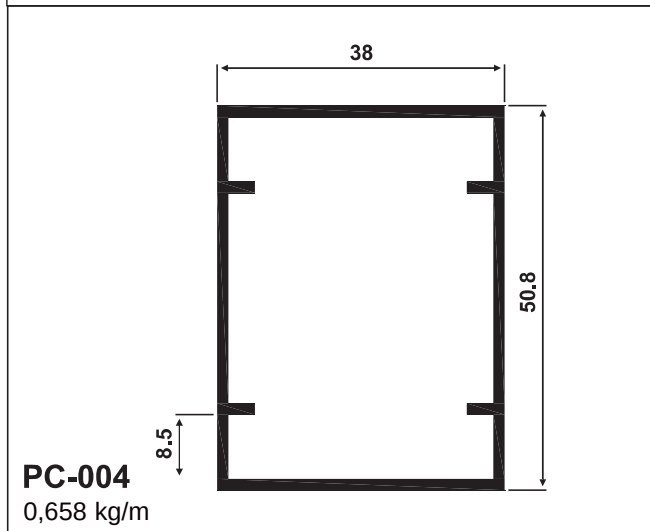
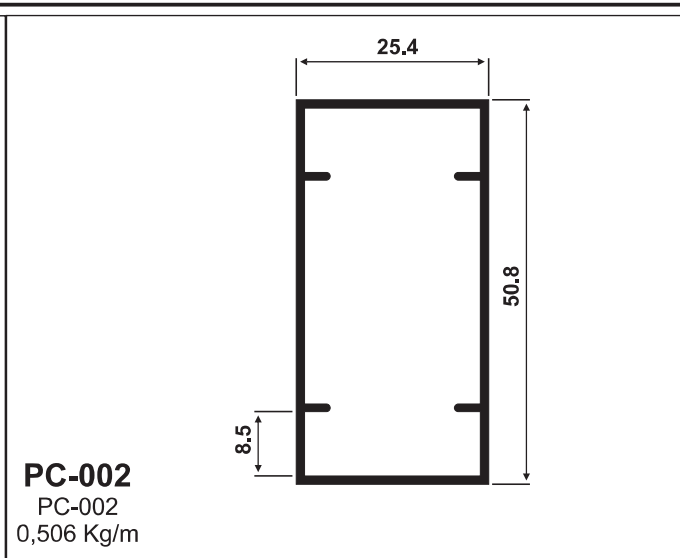
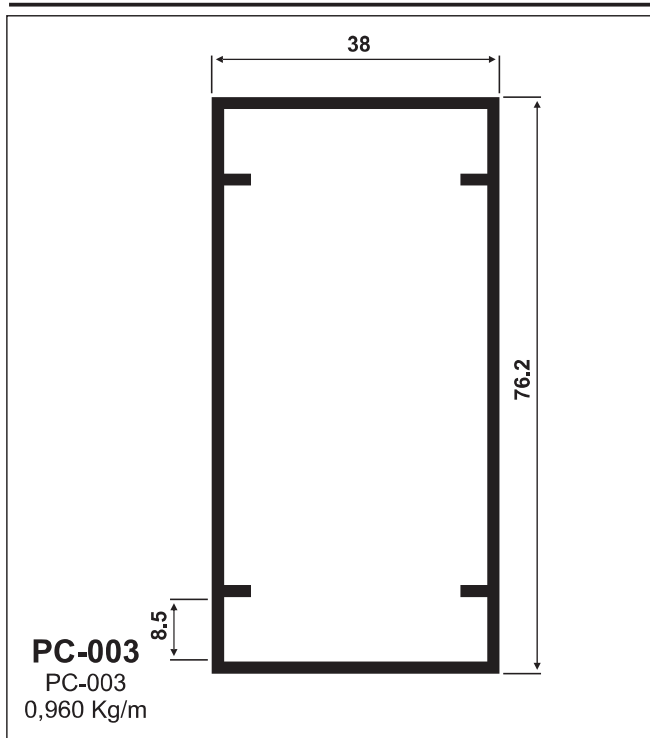

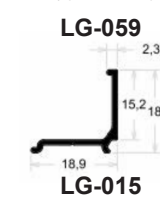
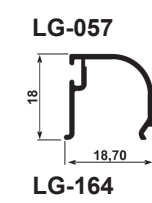
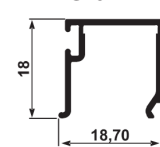
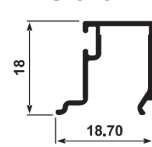
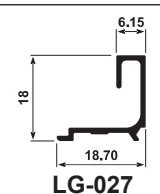
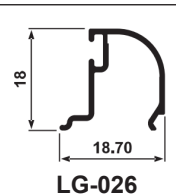
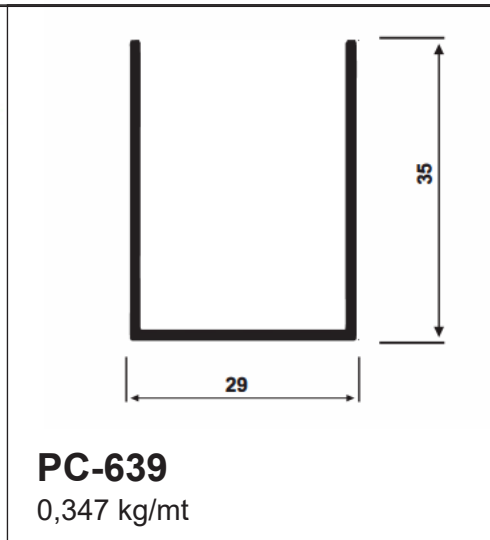
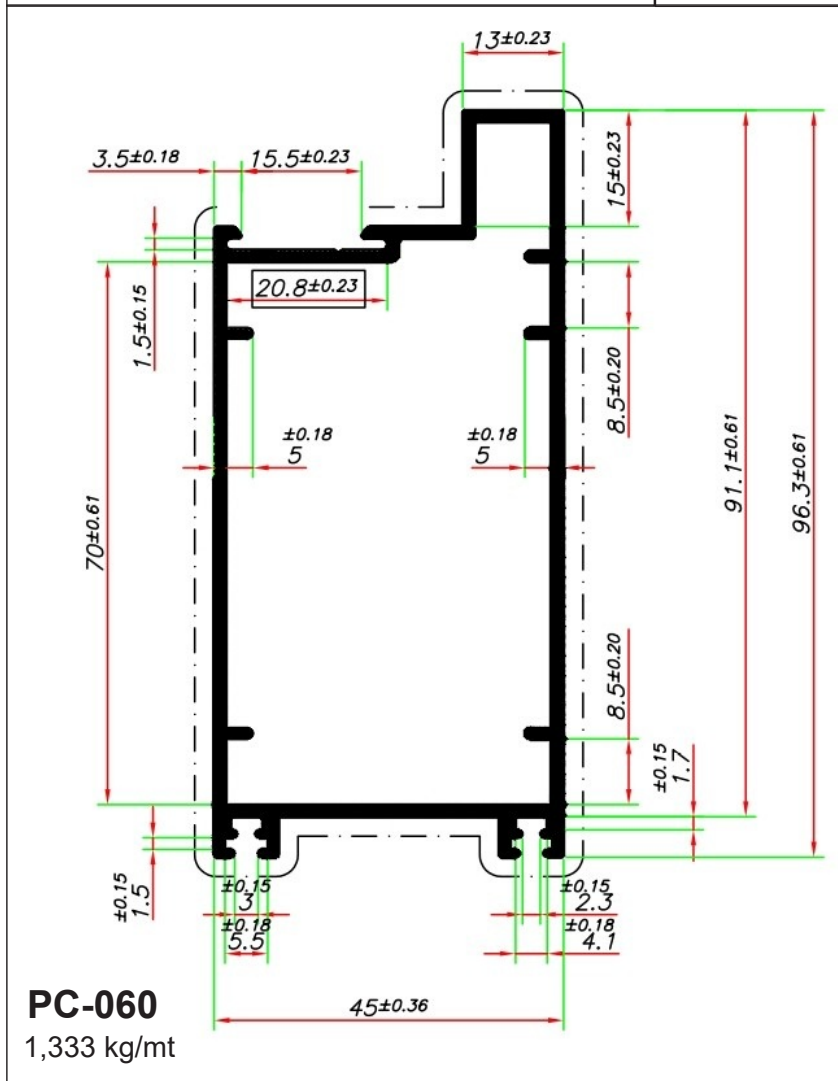
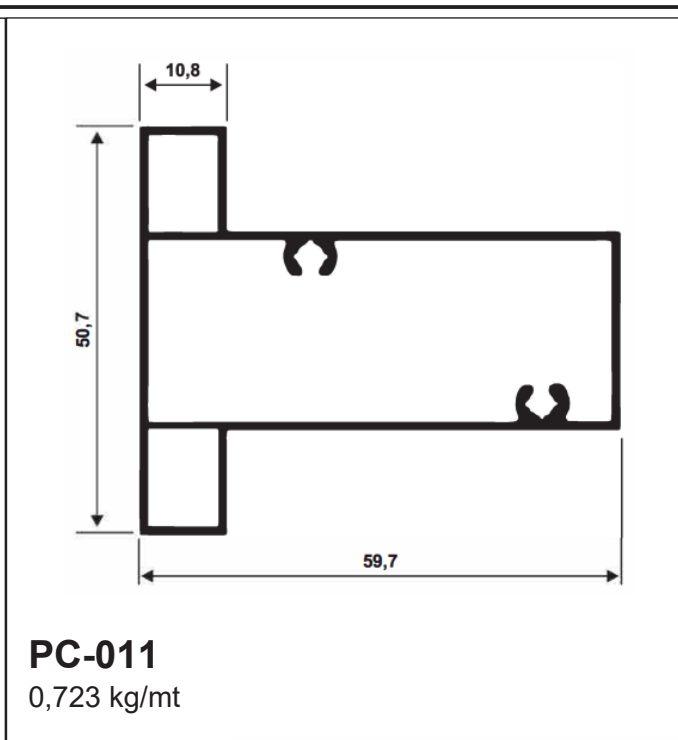
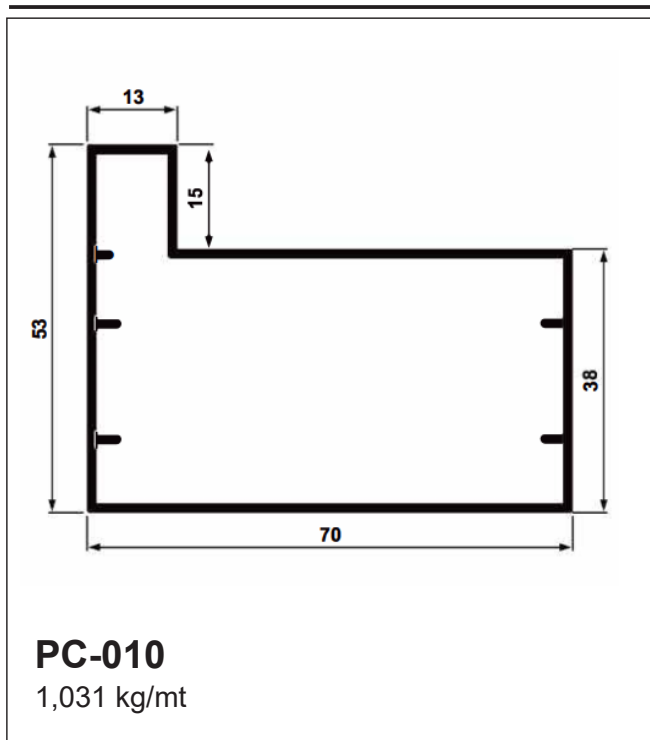

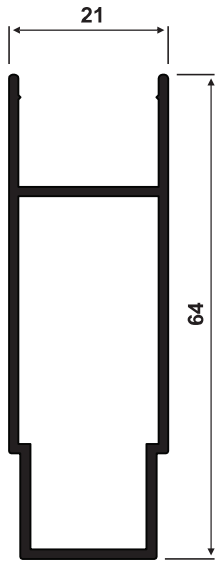

LB-166
0,583 kg/m

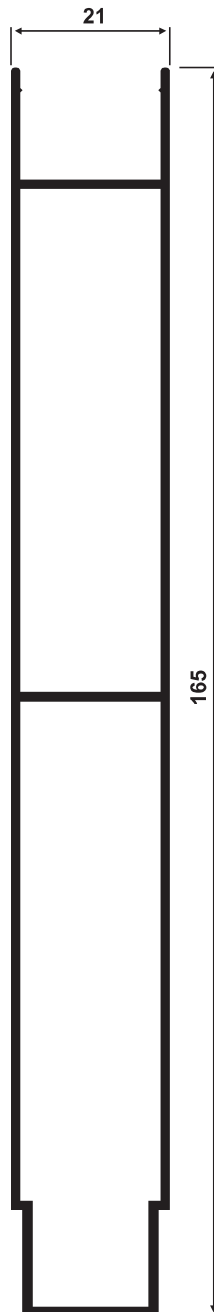

LB-165
1,354 kg/m

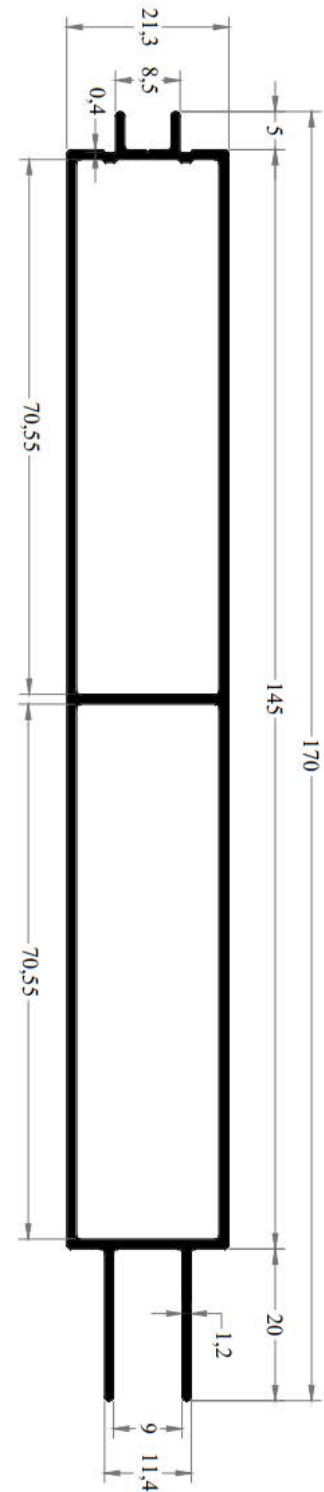

LB-042
1,382 kg/mt



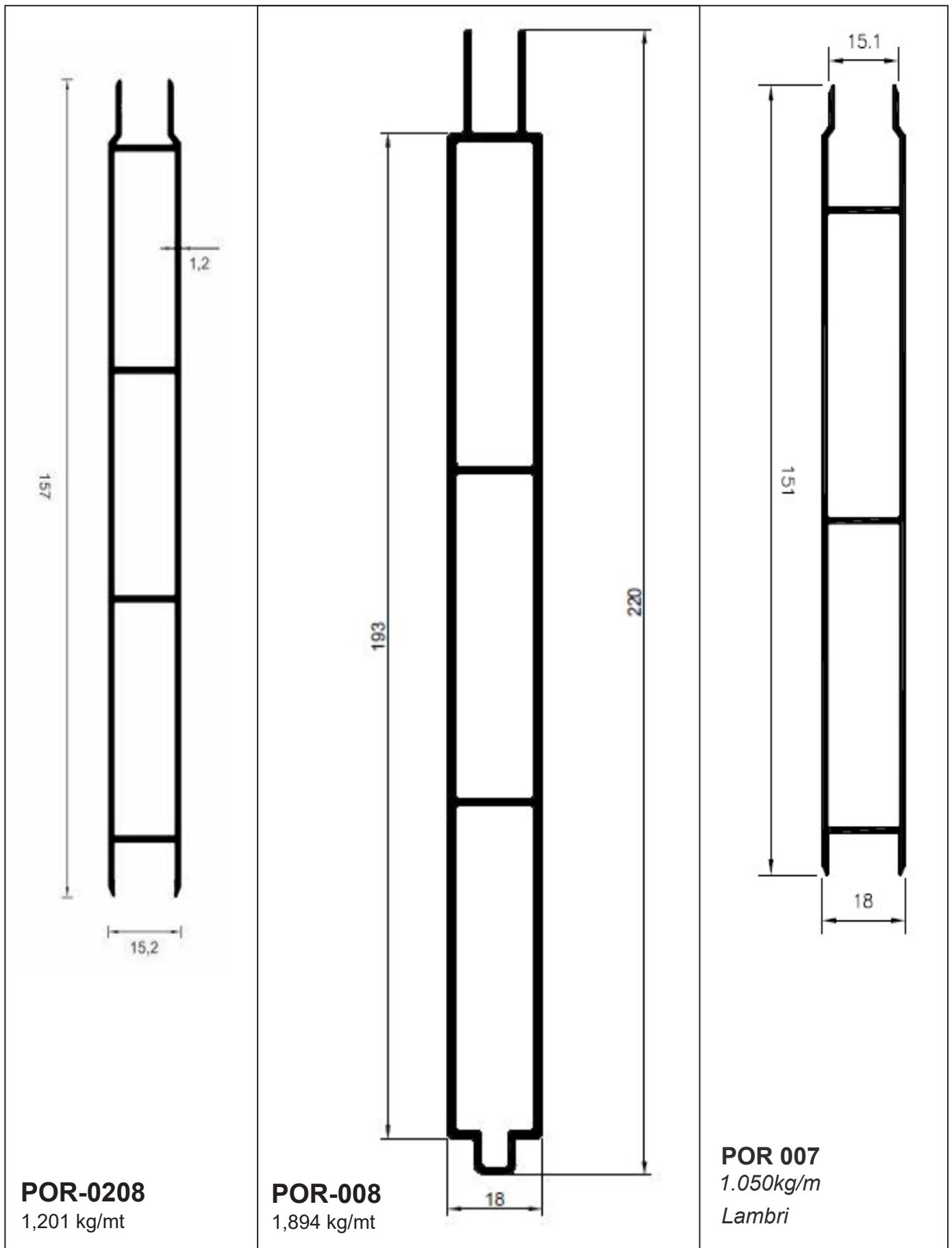

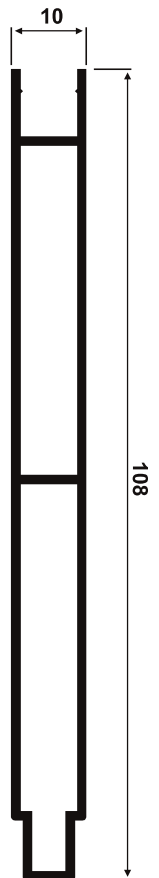
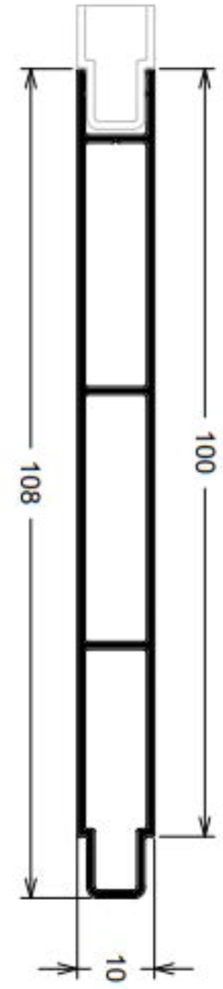
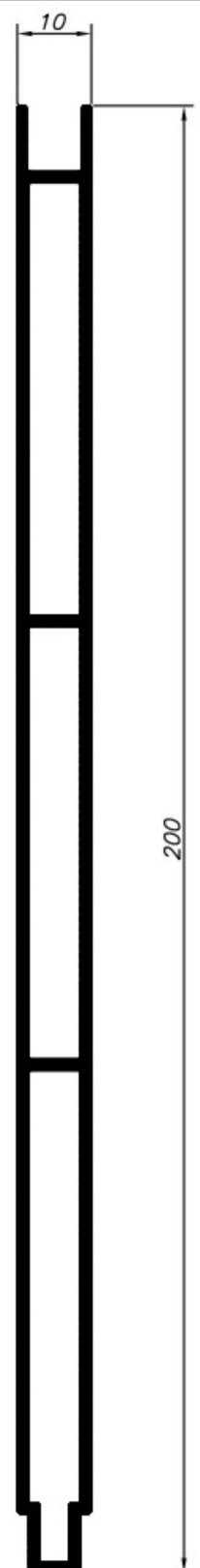
 <p>Technical drawing of the LB-108 lambris profile. It shows a vertical cross-section with a width of 10 units and a total height of 108 units. The profile has a central rectangular cutout and a small notch at the bottom.</p> <p>LB-108 0,843 kg/m</p>	 <p>Technical drawing of the LB-108 LEVE lambris profile. It shows a vertical cross-section with a width of 10 units and a total height of 108 units. The profile features a central rectangular cutout and a notch at the bottom. A detail view at the top shows a U-shaped groove with a depth of 100 units.</p> <p>LB-108 LEVE 0,671 kg/m</p>	 <p>Technical drawing of the LB-210 lambris profile. It shows a vertical cross-section with a width of 10 units and a total height of 200 units. The profile has a central rectangular cutout and a notch at the bottom.</p> <p>LB-210 1,797 kg/mt</p>
--	---	---



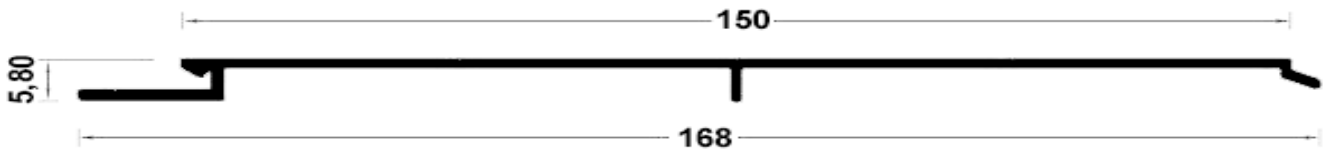

LB-035LEVE
0,572 kg/mt

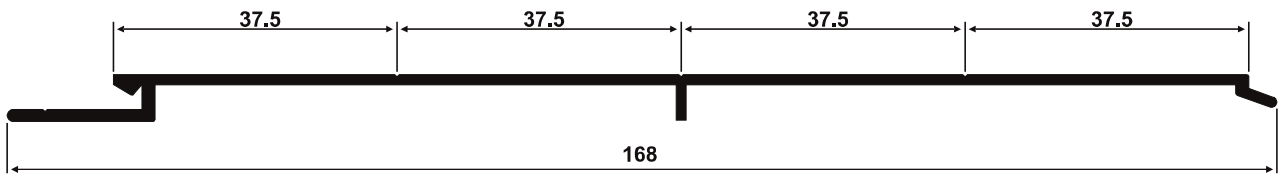

LB-036
0,722 kg/m

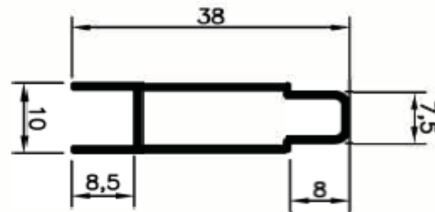

LB-109
0,245 kg/mt

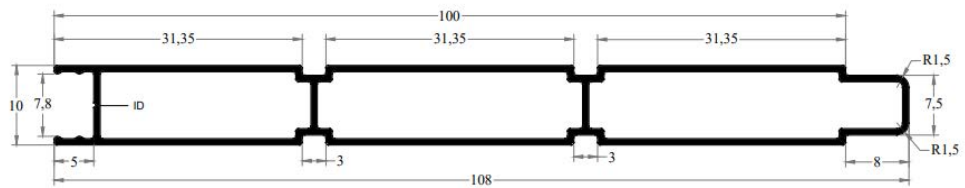

LB-063
0,552 kg/mt

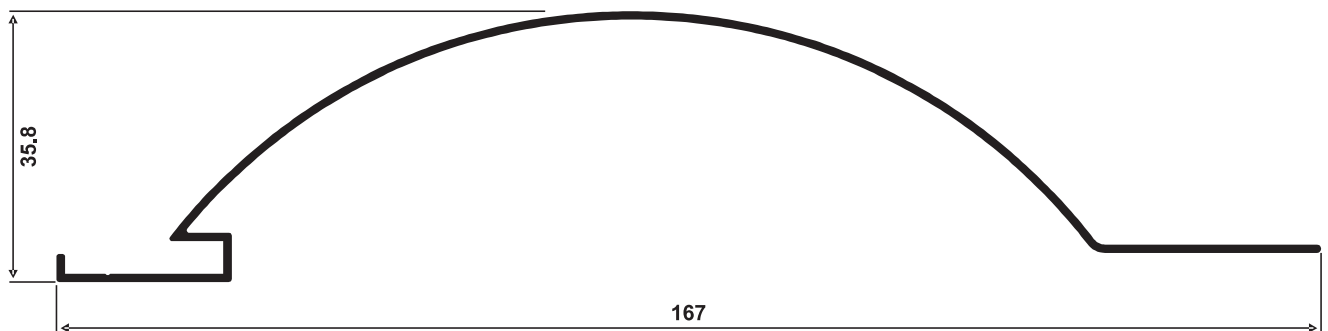

LB-038
0,693 kg/m



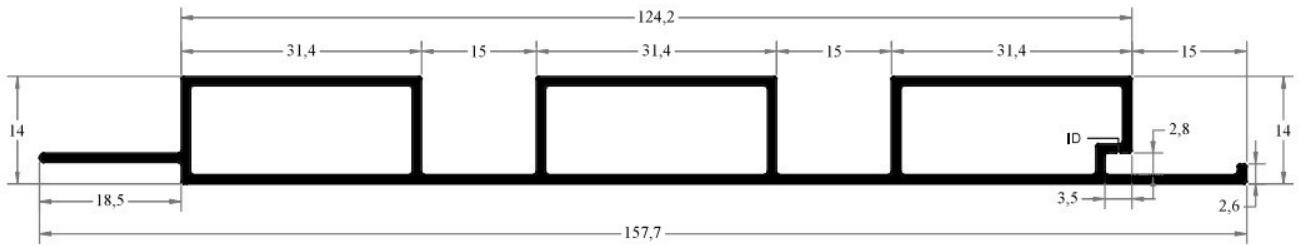

LB-069
1,061 kg/mt



LB-050
0,529 kg/mt

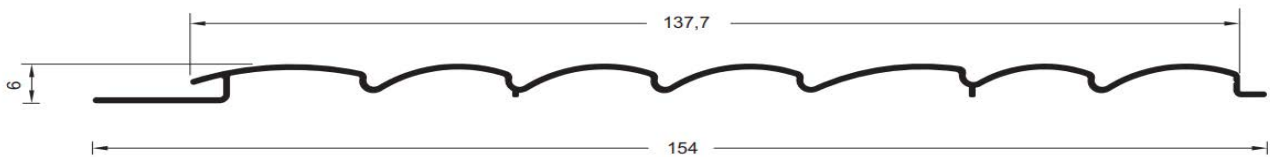

LB-005
0,446 kg/mt

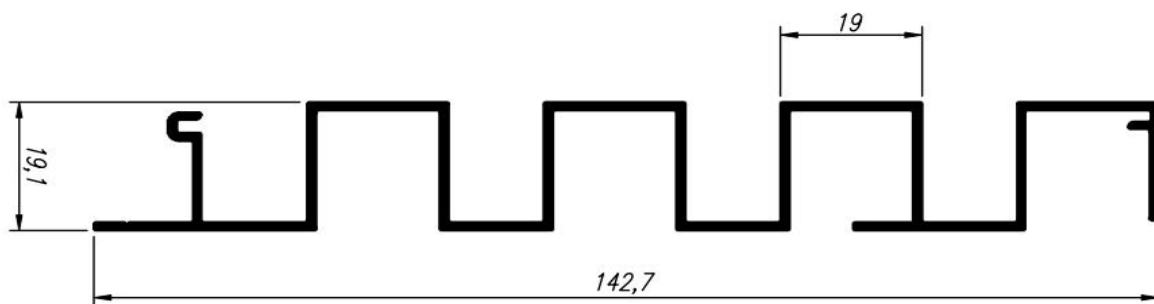

ES-2414
1,051 kg/mt



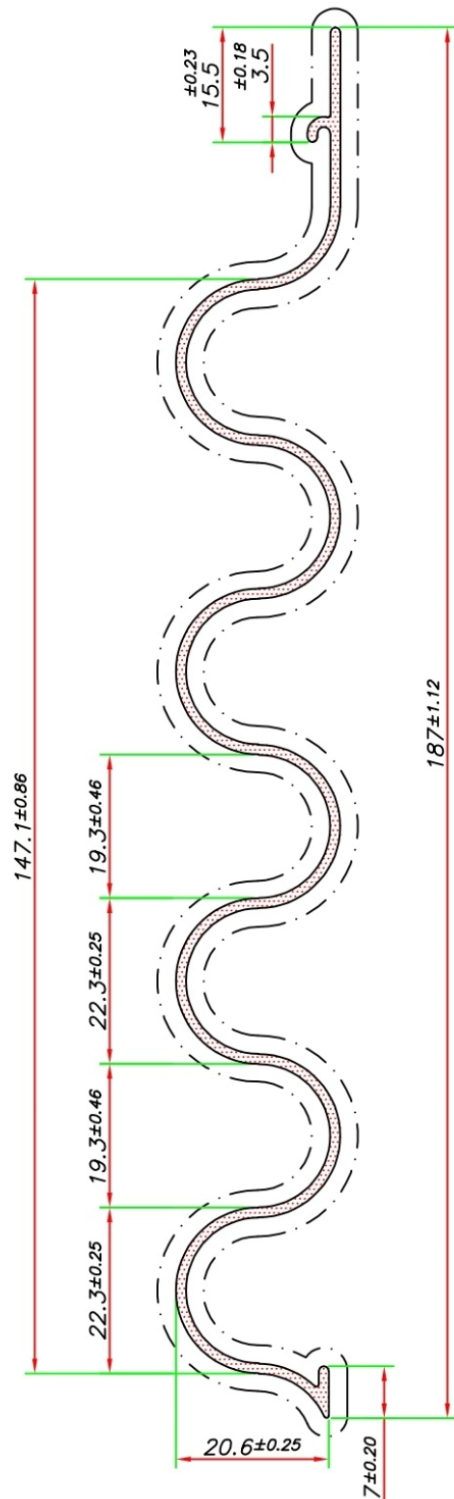

LB-062
1,060 kg/mt



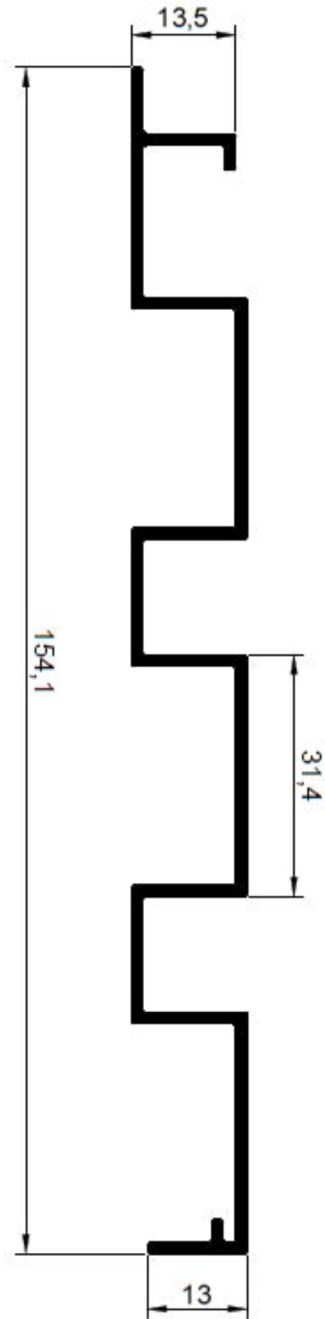

LB-075 (Ripado)
0,793 kg/mt

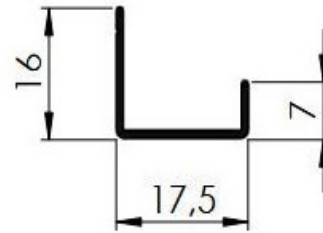

DS-075
0,093 kg/mt

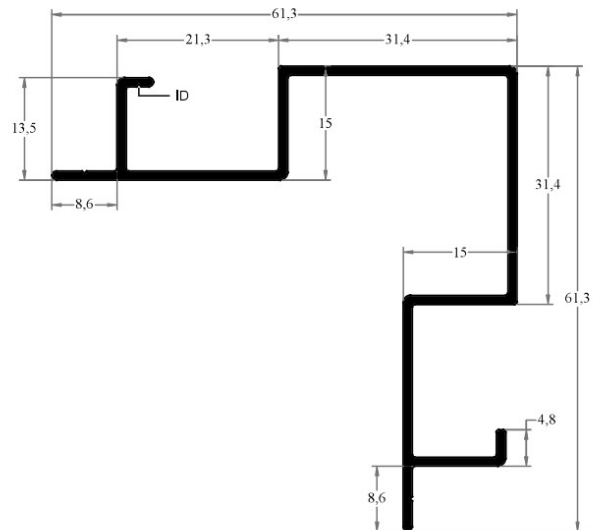

LB-076
0,583 kg/mt



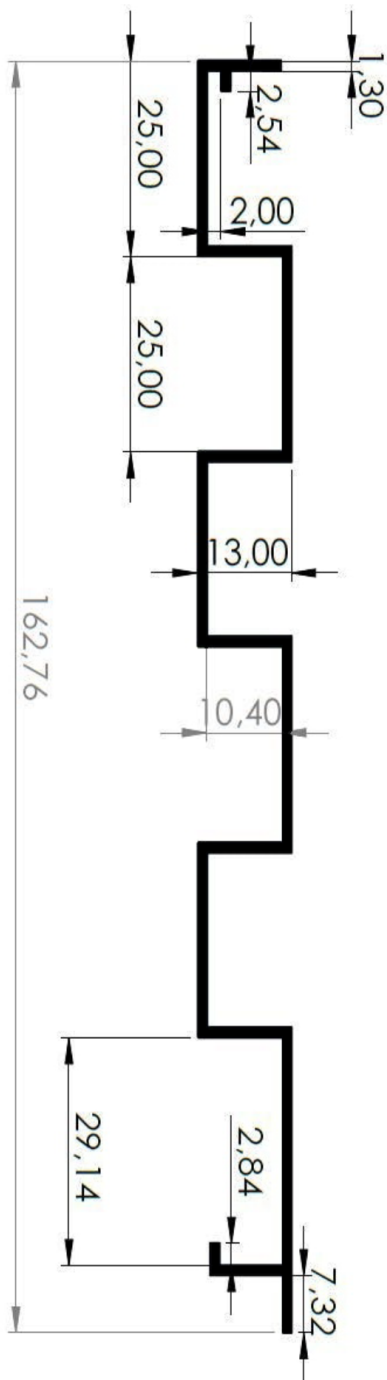

LB-025

0,869 kg/mt

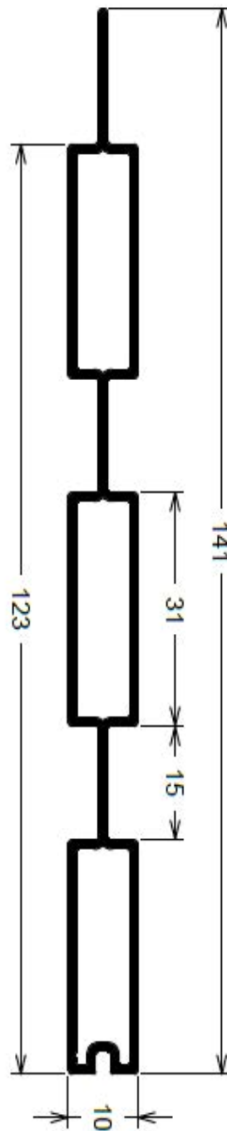

LB-085

0,933 kg/mt

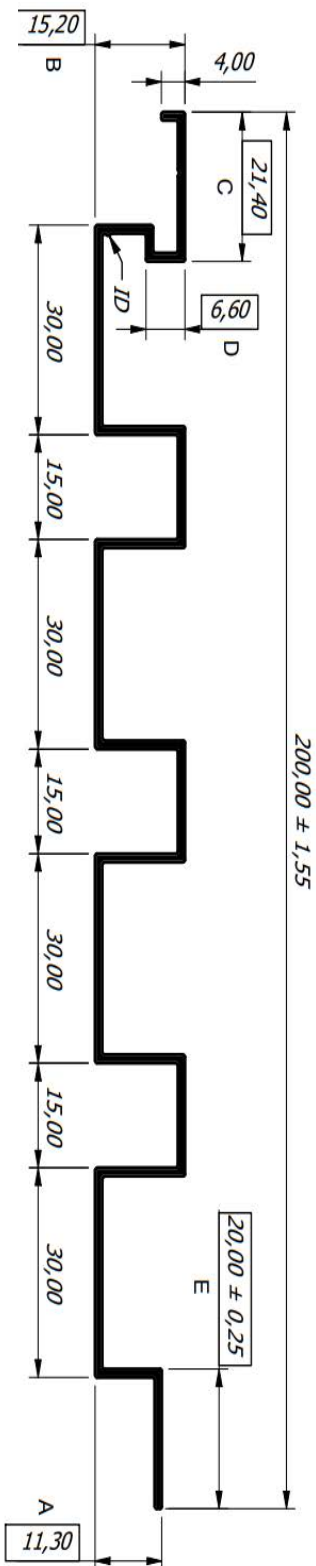

LB-200

1,033 kg/mt

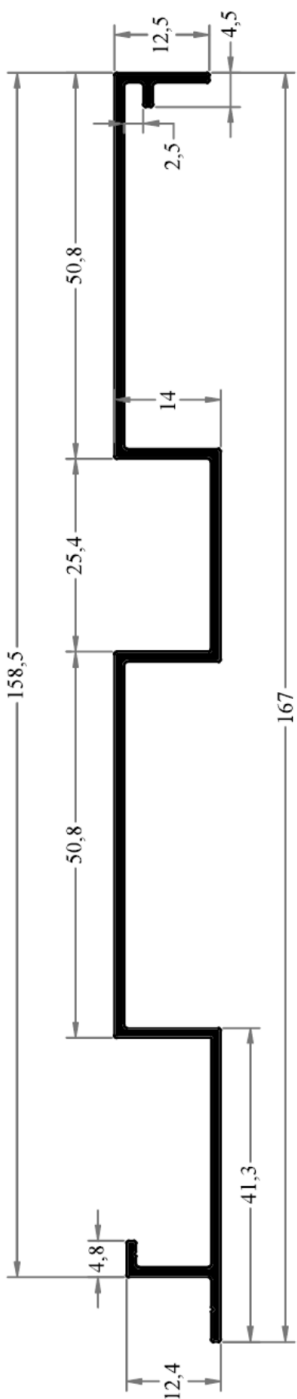
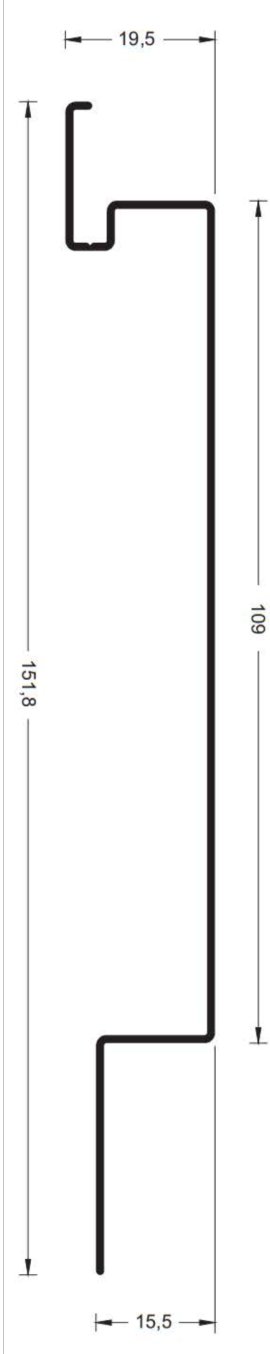
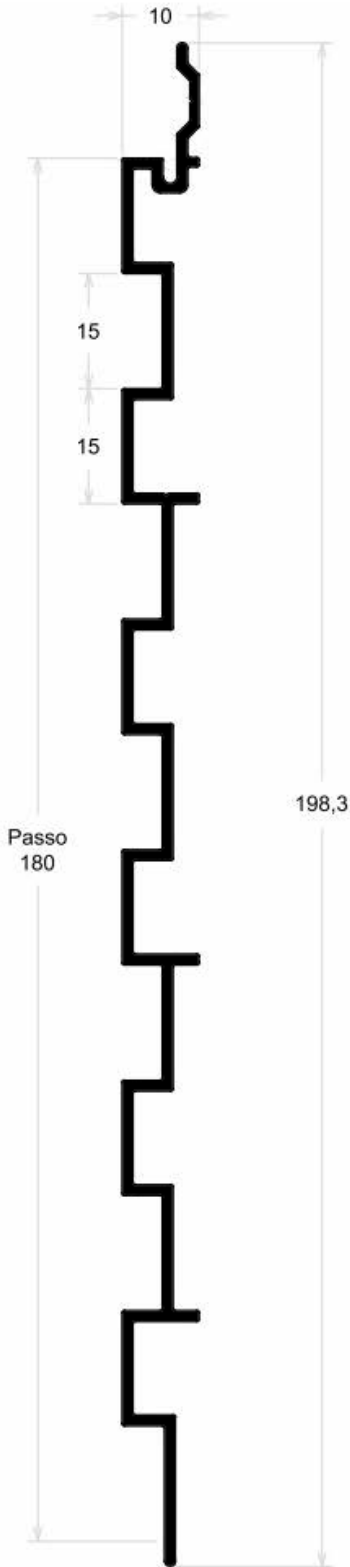
 <p>LB-092 0,823 kg/mt</p>	 <p>LB-065 0,556 kg/mt</p>	 <p>LB-090 1,067 kg/mt</p>
---	---	---





LB-100

1,660 kg/mt

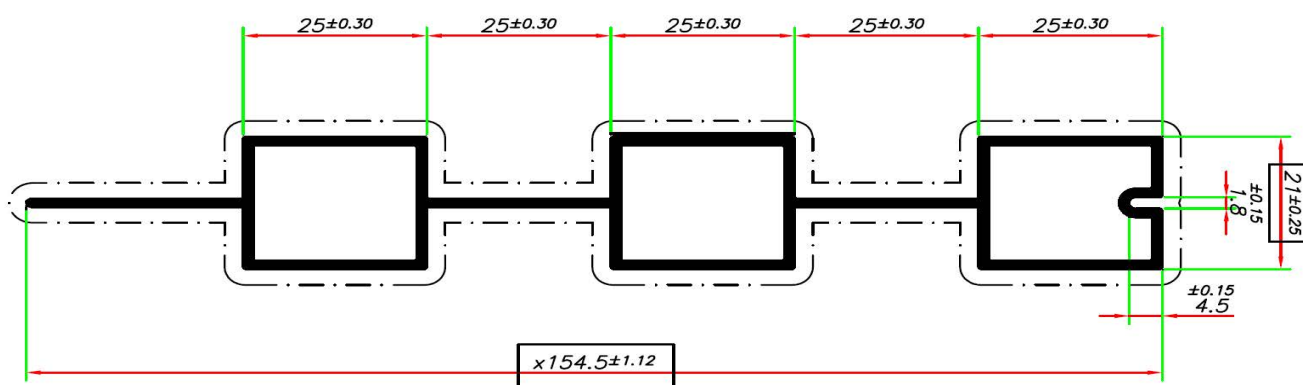

LB-500

1,314 kg/mt

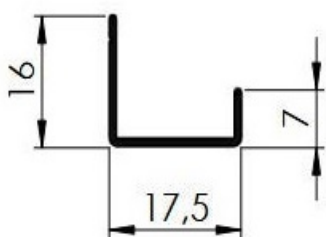

DS-075

0,093 kg/mt



BC-015

0,233 kg/mt

DV-075

0,342 kg/mt

Aplicação

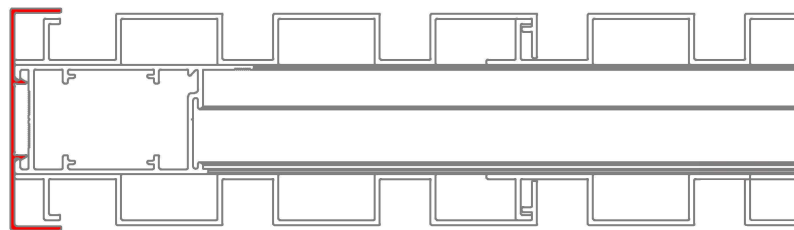
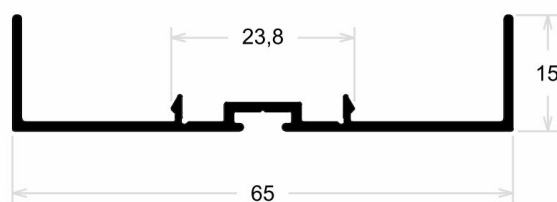

PERFIS PARA MUXARABI

REVESTIMENTO/DECORAÇÃO

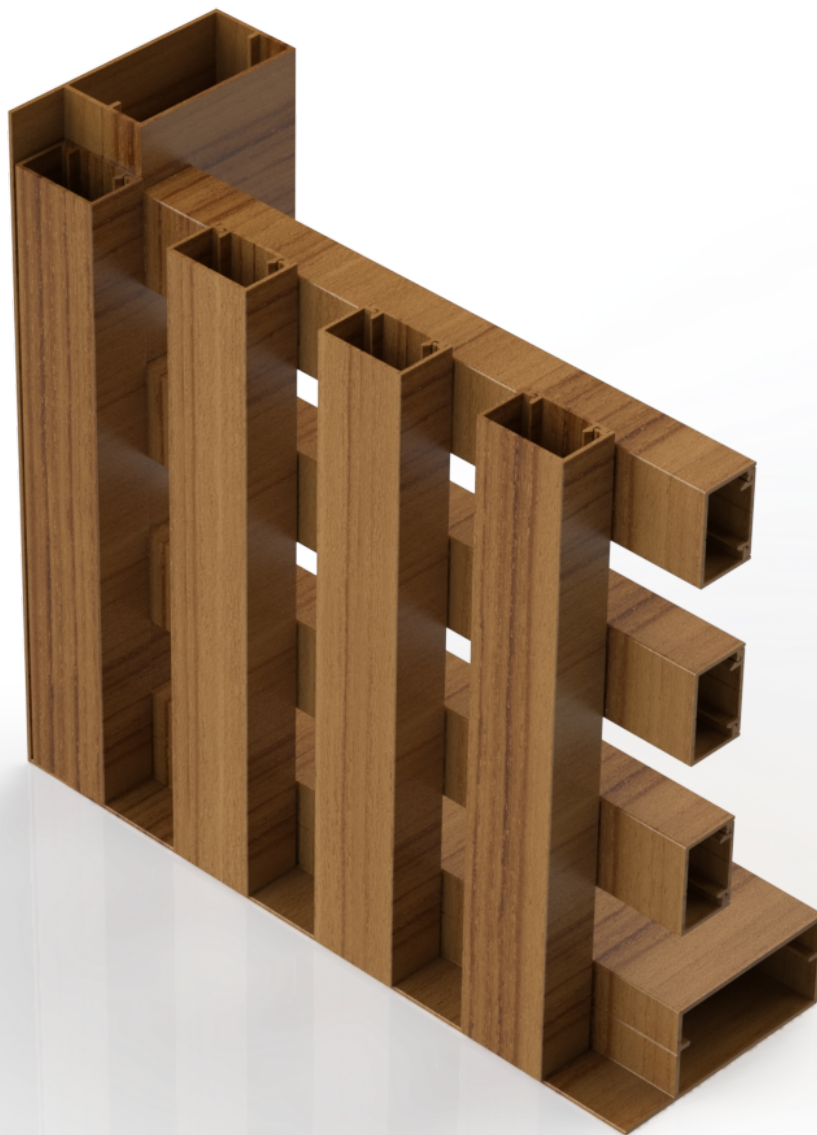

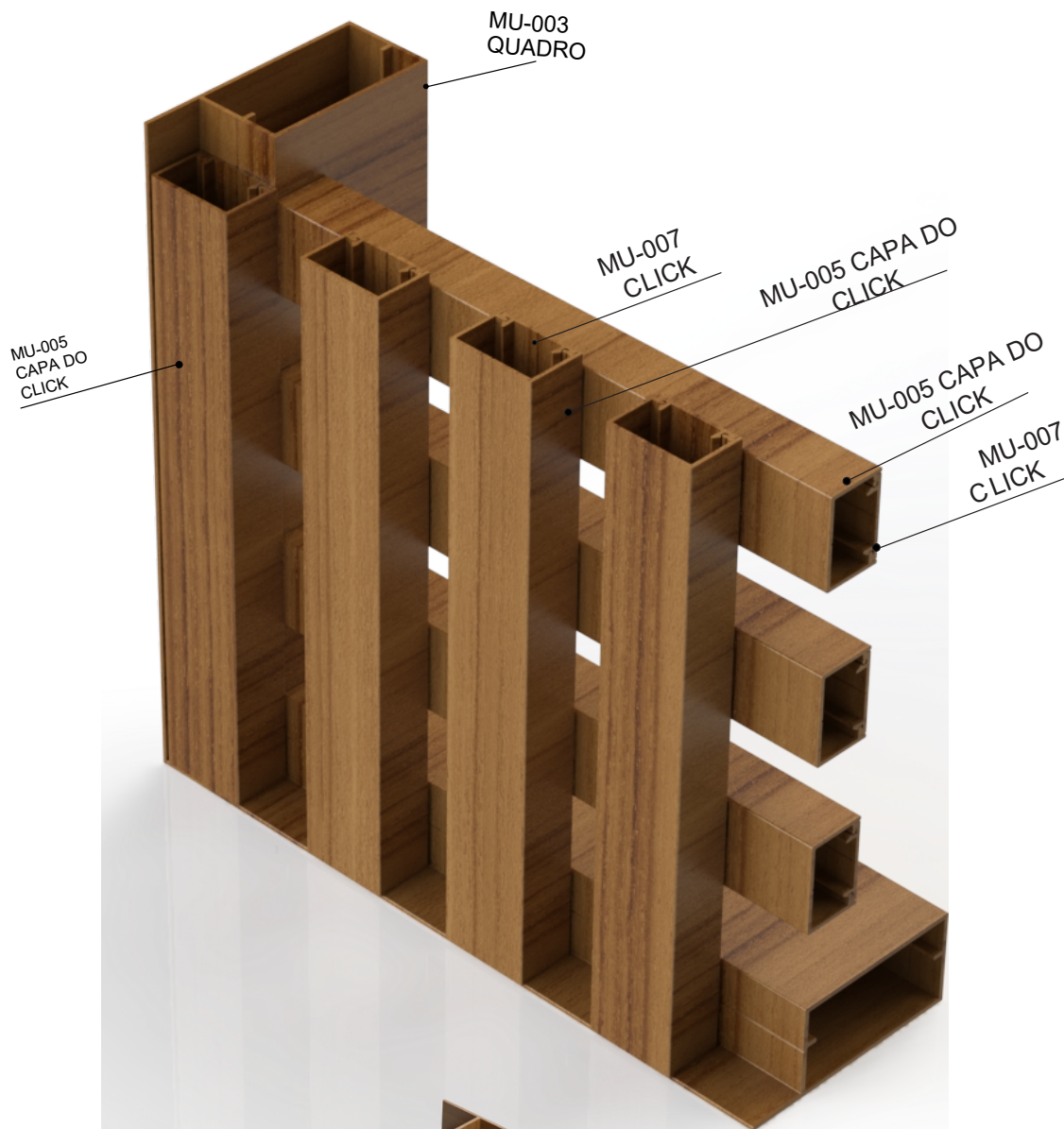

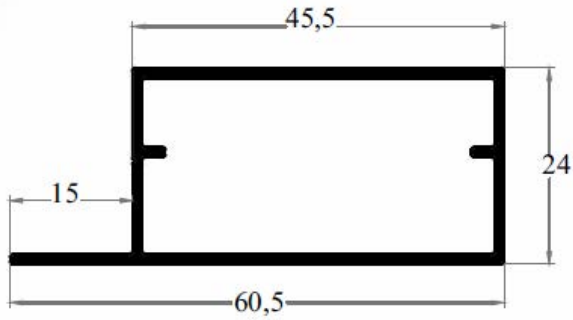

MU-003

0,503 kg/mt

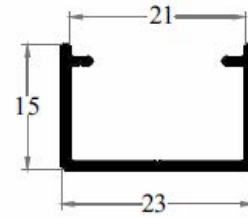

MU-004

0,151 kg/mt

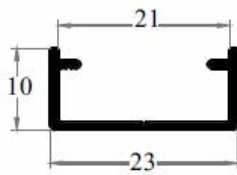

MU-005

0,124 kg/mt

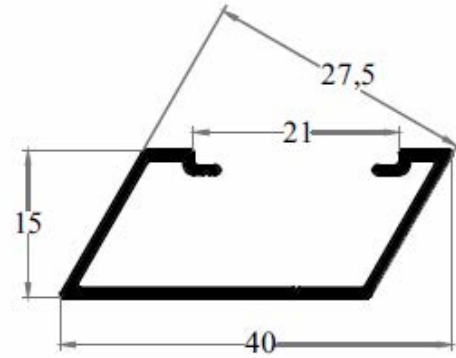

MU-006

0,217 kg/mt

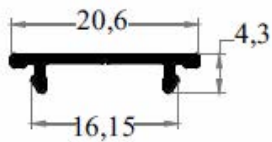

MU-007

0,077 kg/mt

MUXARABI

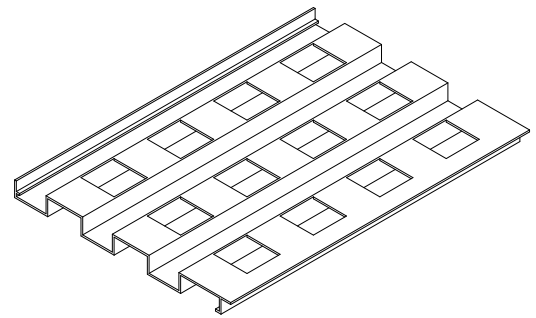
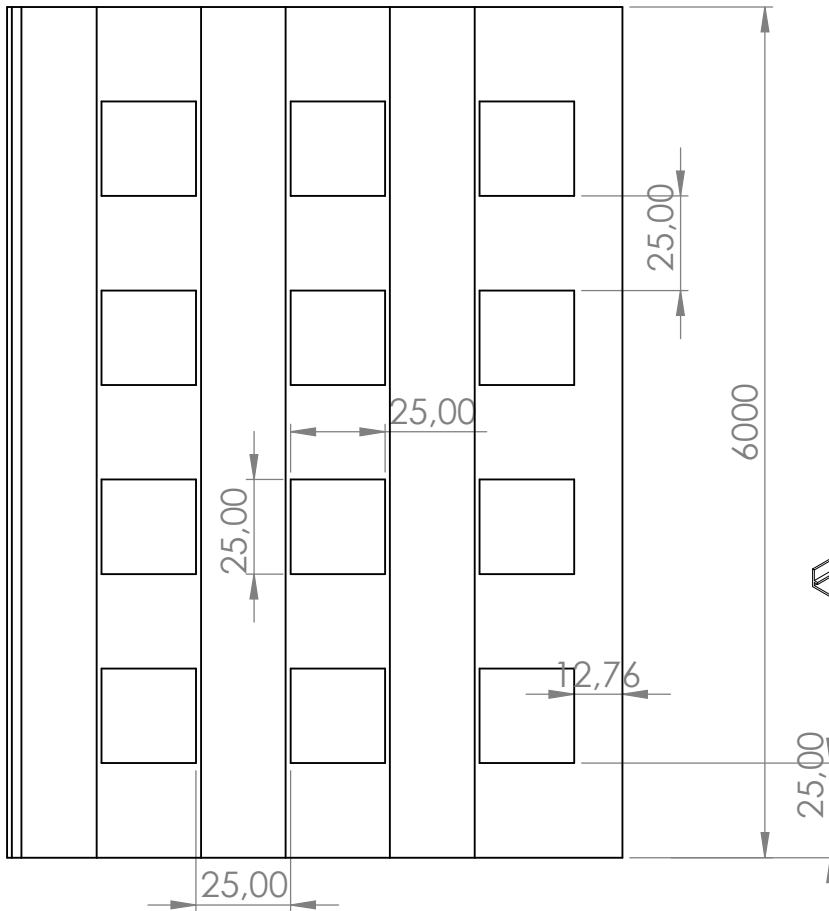

Parte posterior do perfil

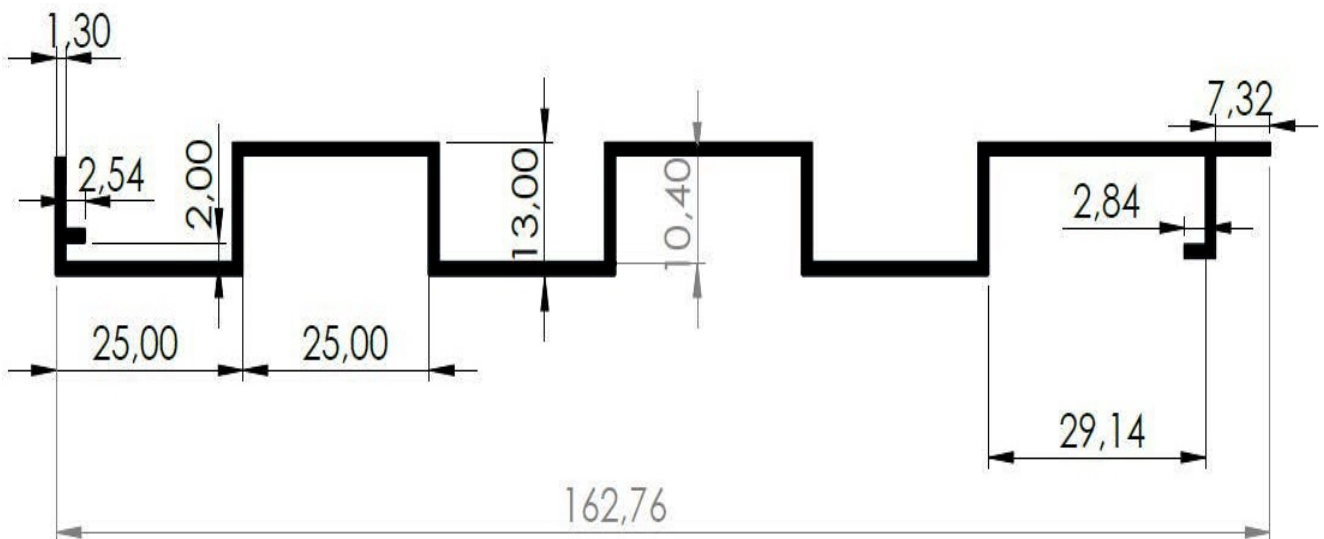

MU-025 (PERFIL VAZADO)

0,710 kg/mt



MUXARABI DUPLO

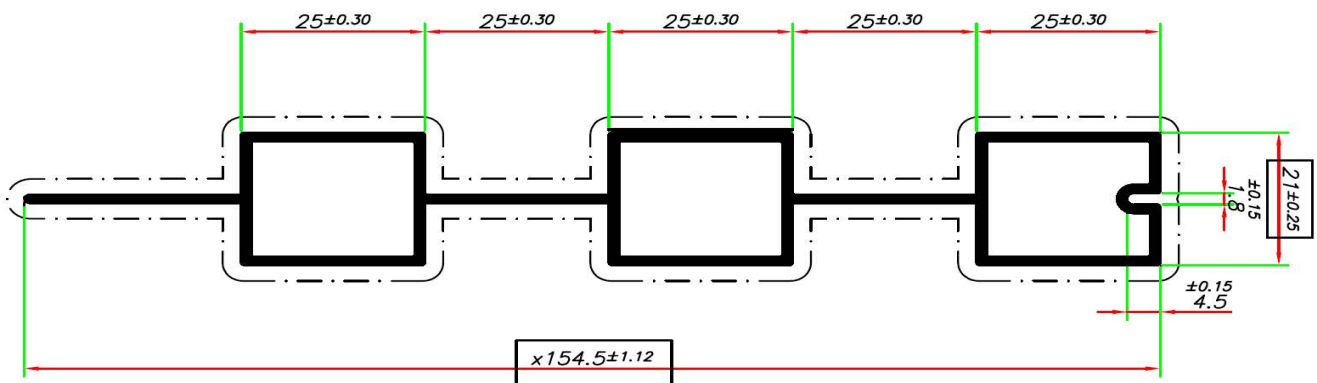
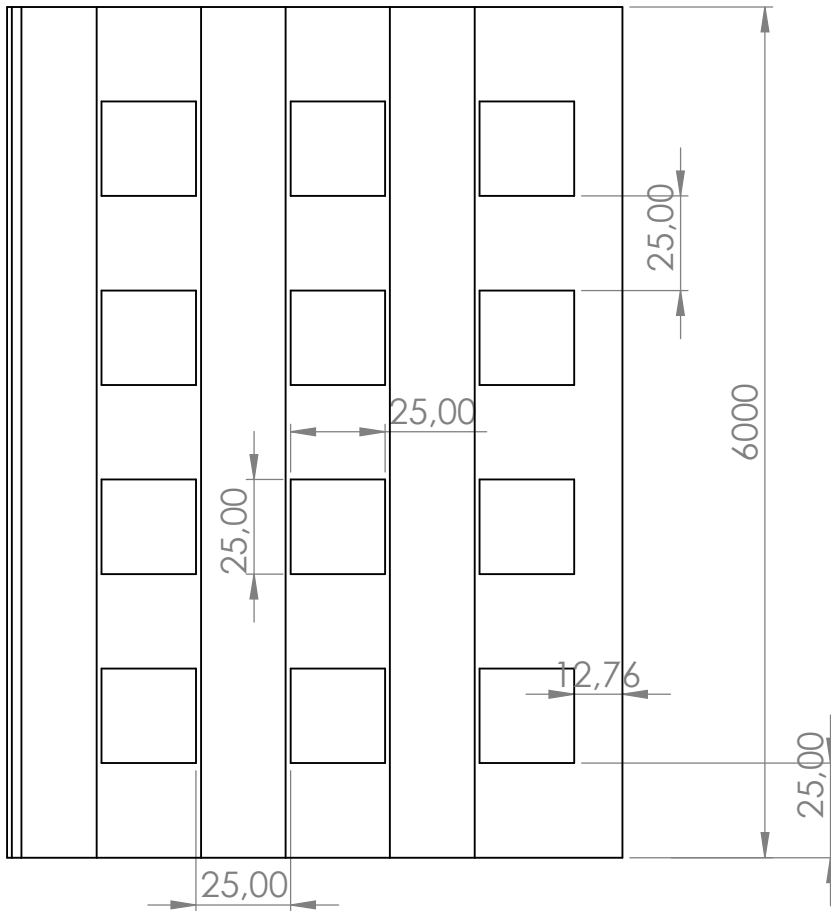

MU-500 (PERFIL VAZADO)

1,314 kg/mt



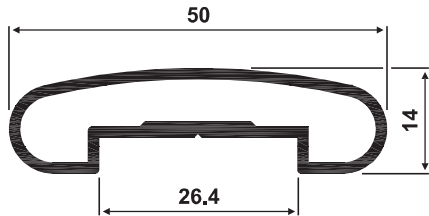

GR-003
CG-003
0,507 kg/m

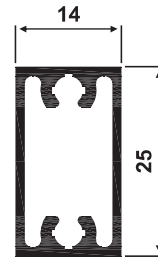

GR-21
CG-021
0,327 kg/m

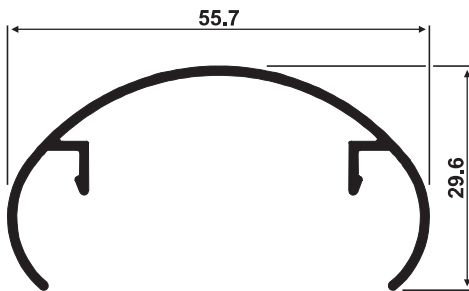

GR-78
CG-078
0,379 kg/m

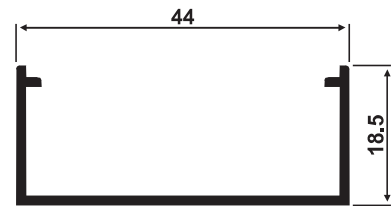

GR-79
CG-079
0,289 kg/m

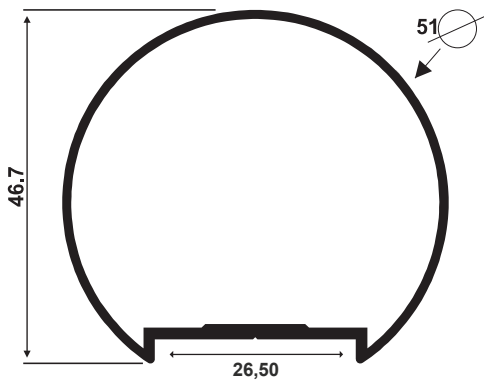

GR-71
CG-071
0,635 kg/m

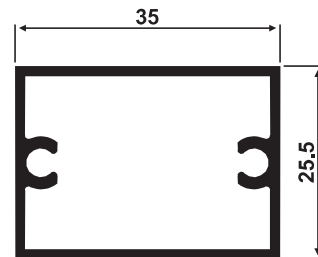

GR-88
CG-012
0,500 kg/m



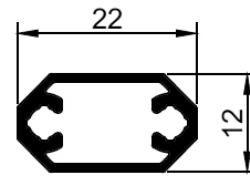

GR-22
0,224 kg/m

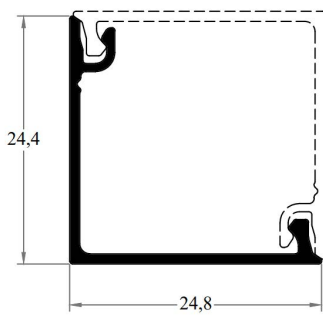

RV-025
0,198 kg/mt

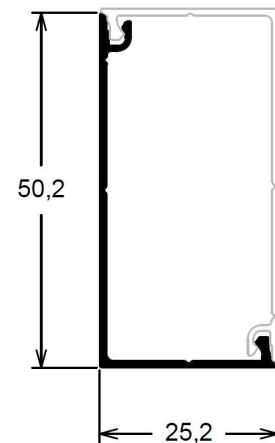

RV-050
0,267 kg/mt

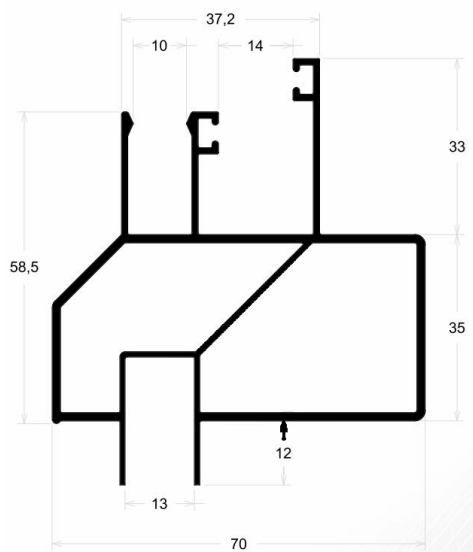

GR-48
1,357 kg/mt

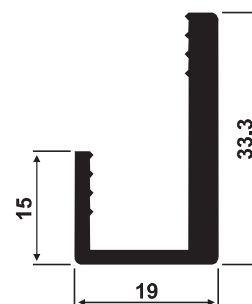

GR-75
CG-075
0,500 kg/m



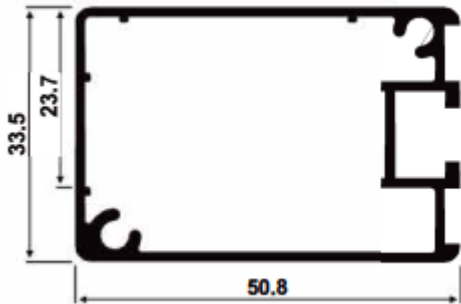

GR-77

0,732 kg/mt

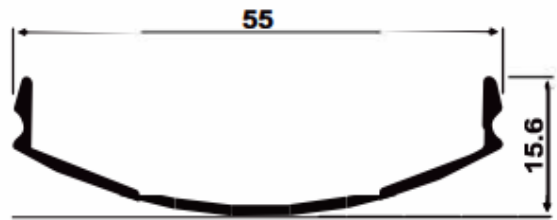

GR-74

0,242 kg/mt

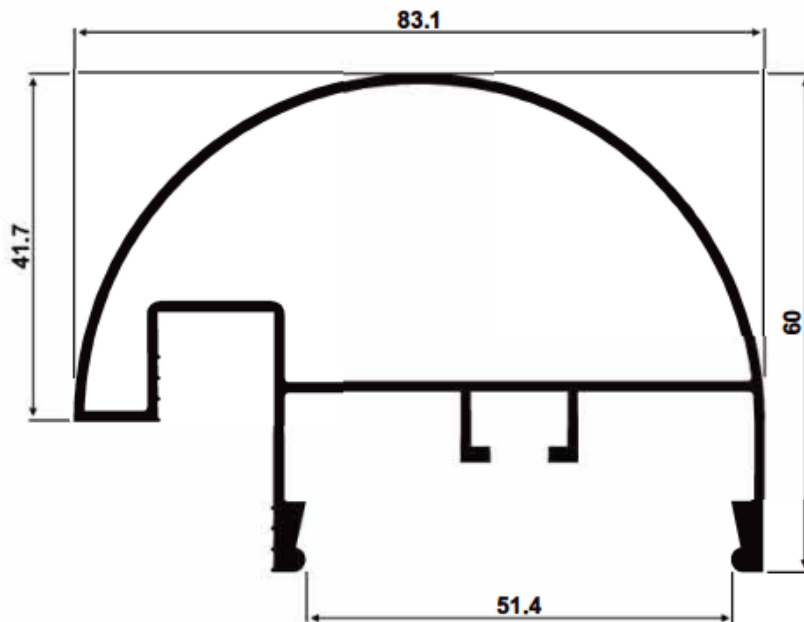

GR-84

1,096 kg/mt

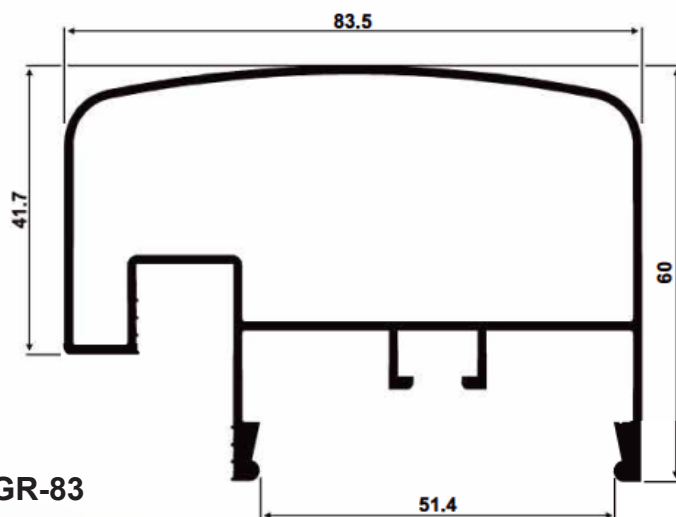

GR-83

1,199 kg/mt

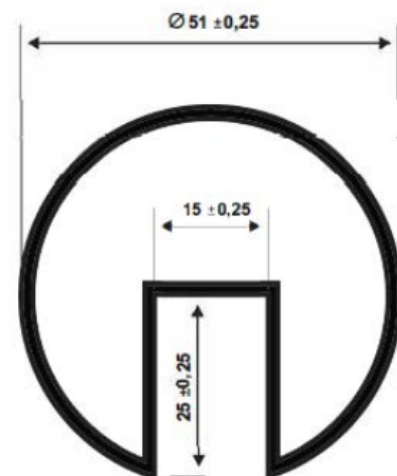

GR-001



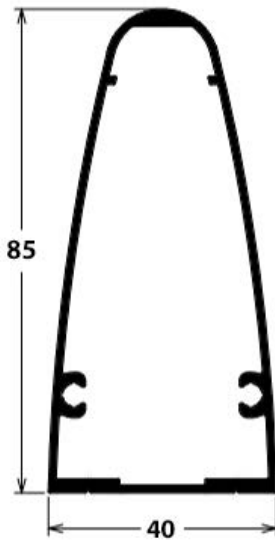

GR-833

0,993 kg/m

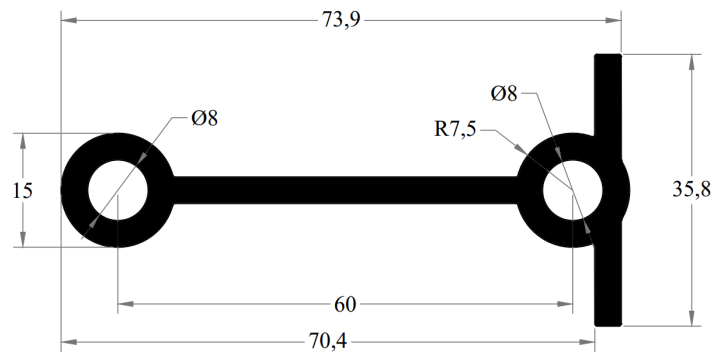

GR-834

1,343 kg/m

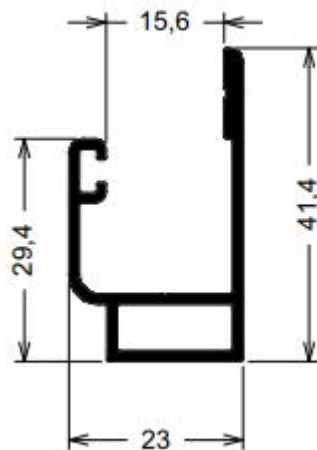

GR-887

0,460 kg/m



GR-885

1,268 kg/m



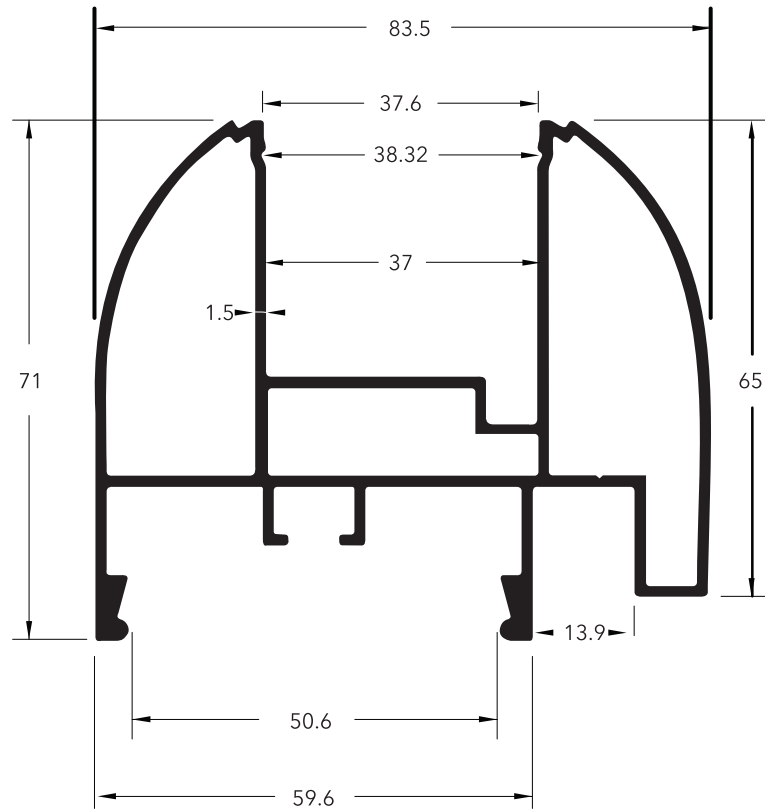

CX-001
1,875 kg/m

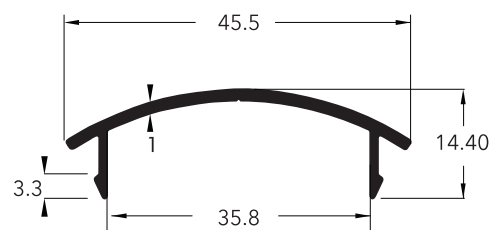

CX-002
0,230 kg/m



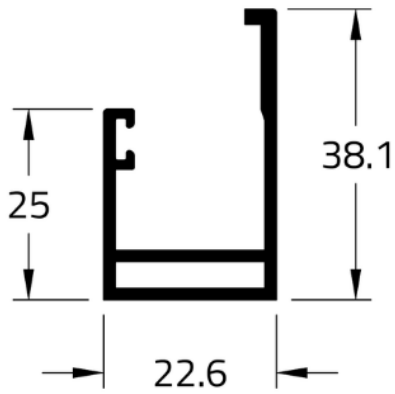

CG-204
0,482 kg/m

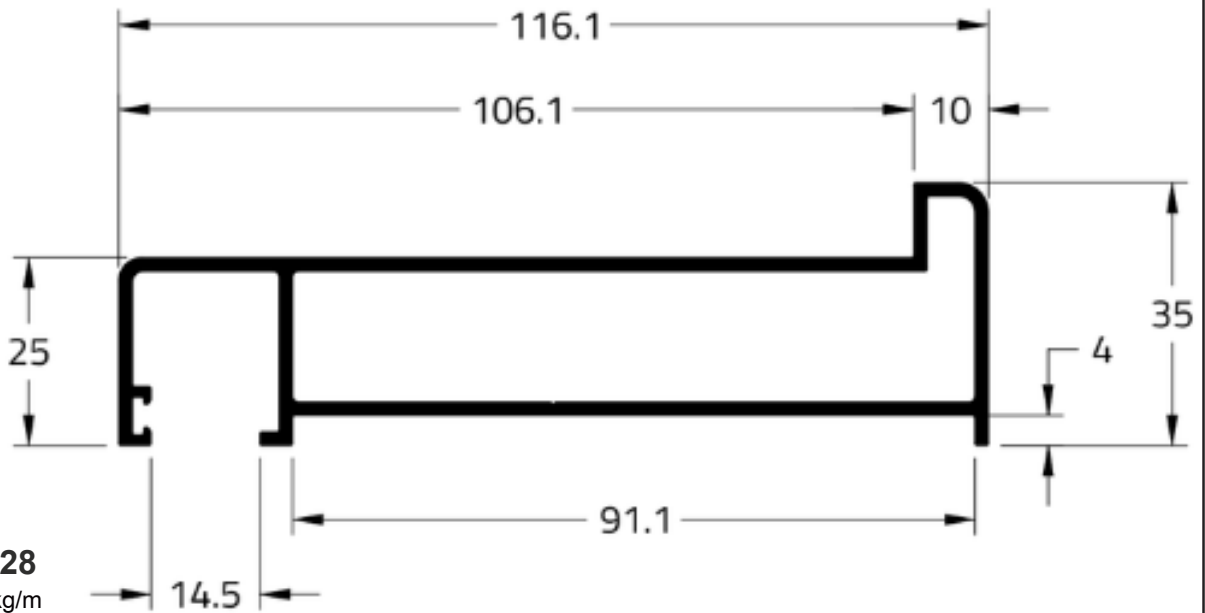

CG-228
1,520 kg/m

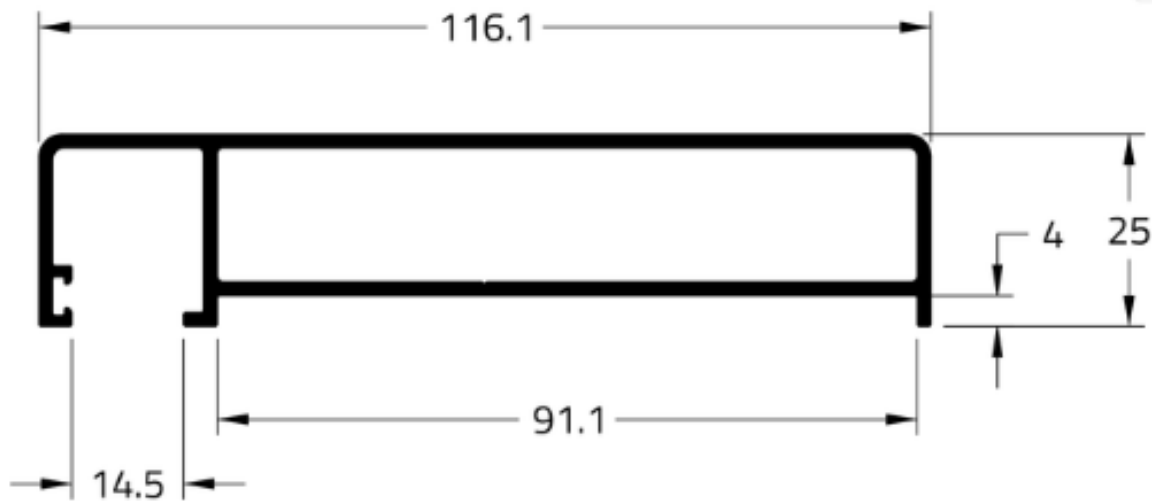

CG-229
1,421 kg/m



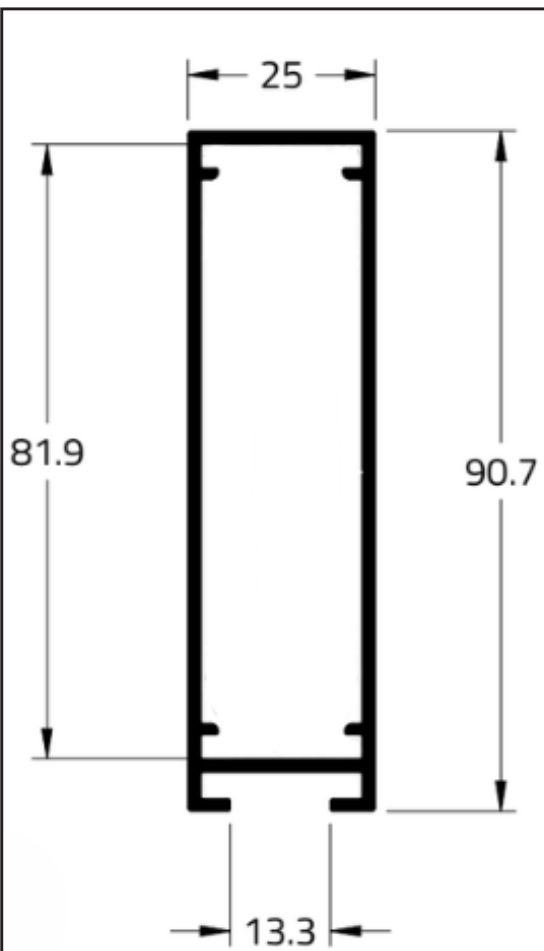

CG-230
1,167 kg/m

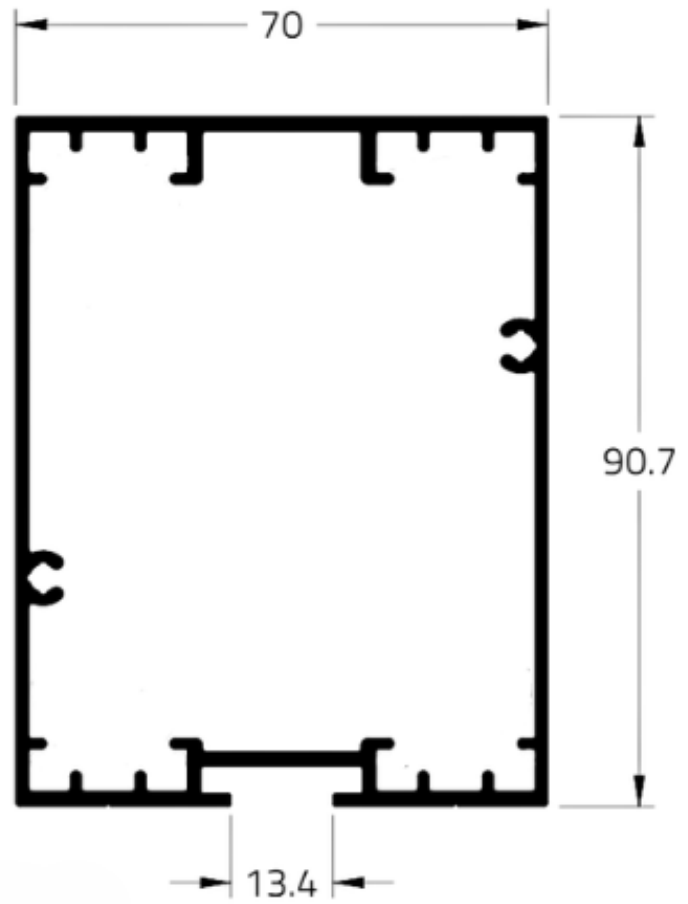

CG-253
2,049 kg/m

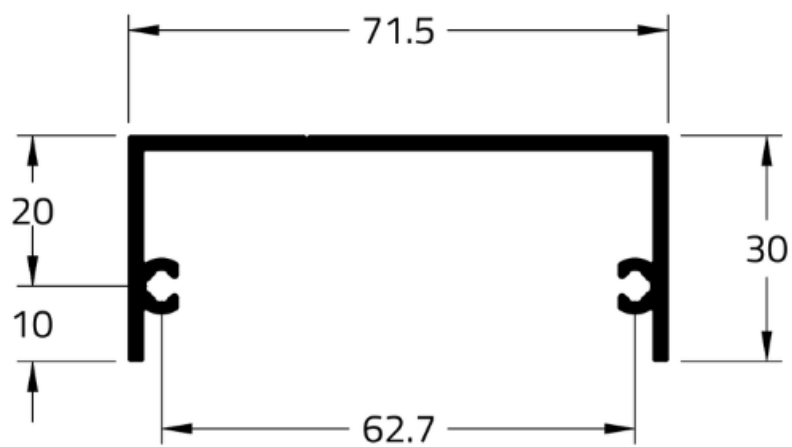

CG-234
0,817 kg/m



GUARDA CORPO AUTOPORTANTE

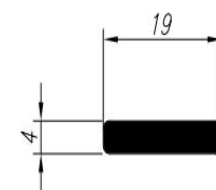
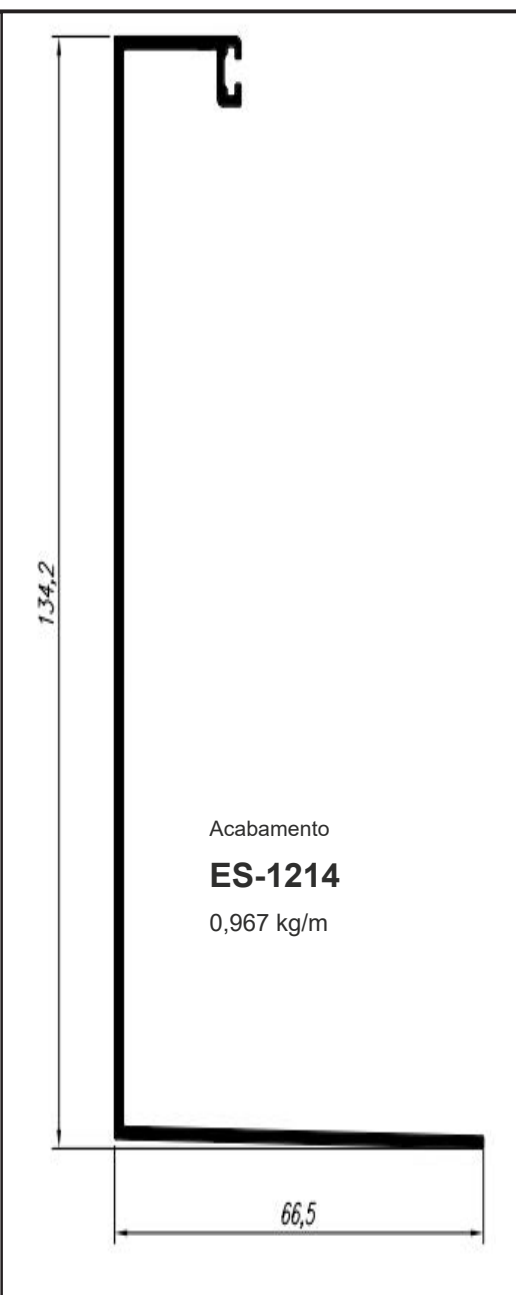
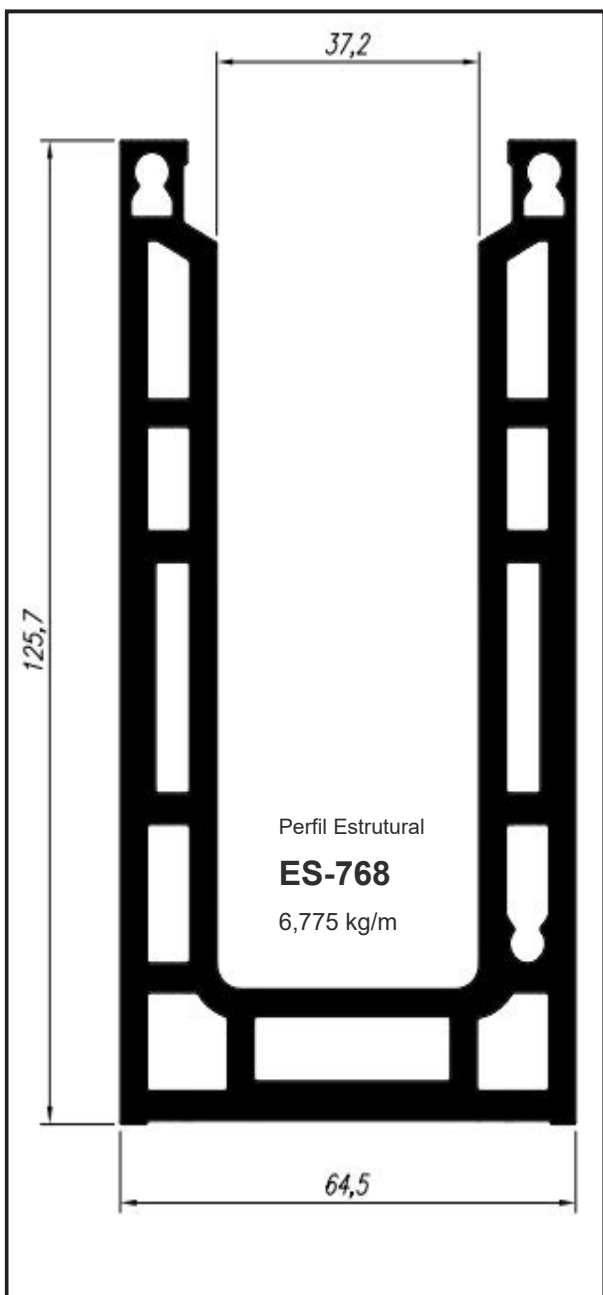

Barra Chata
ES-342

0,203 kg/m

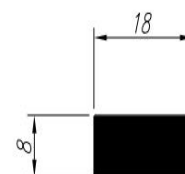

Barra Chata
ES-1316

0,390 kg/m

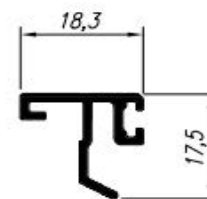

Acabamento
ES-1213

0,183 kg/m

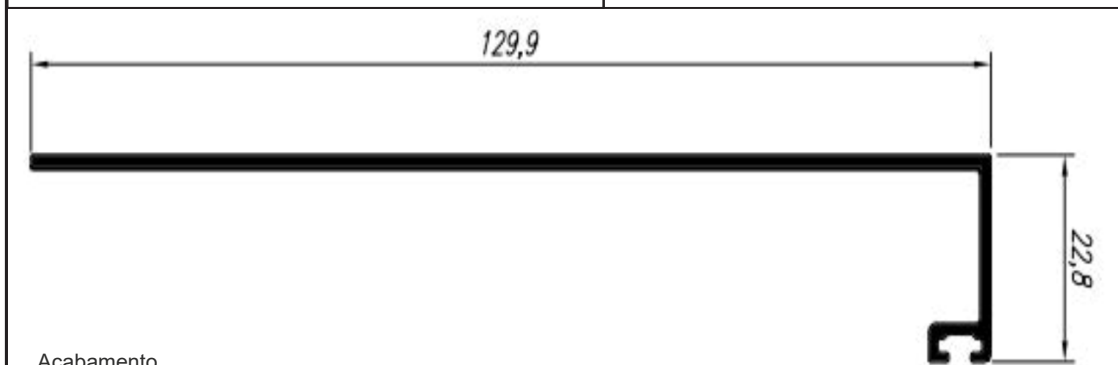

Acabamento
ES-1096
0,654 kg/m

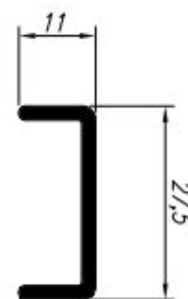

Corrimão
ES-767

0,240 kg/m

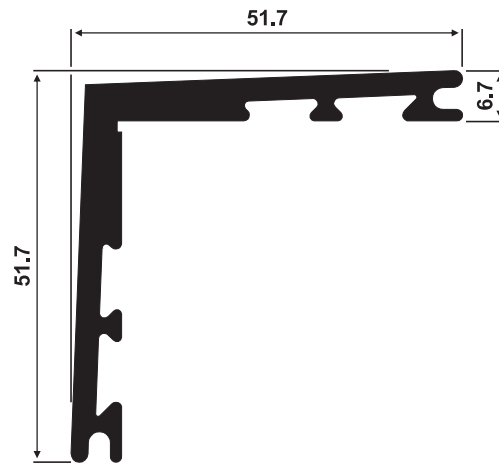

CL-006
CL-006
1,122 kg/m

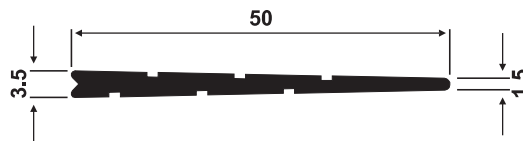

CL-011
CL-011
0,316 kg/m

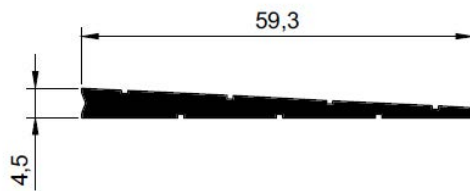

CL-012
0,471 kg/mt



CONTRAMARCOS E ARREMATES

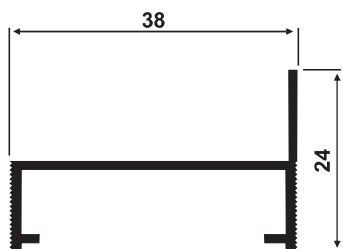

CM-060
0,276 kg/m

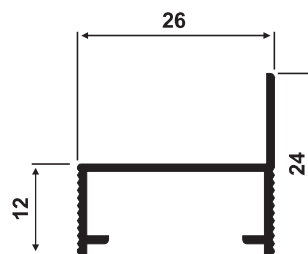

CM-200
0,189 kg/m

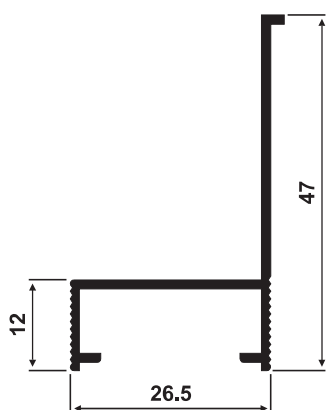

CM-151
0,280 kg/m

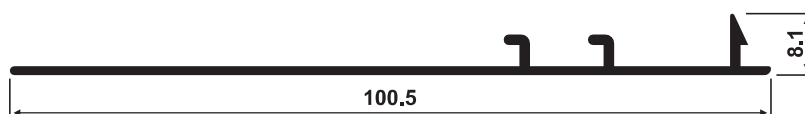

CM-099
0,414 Kg/m

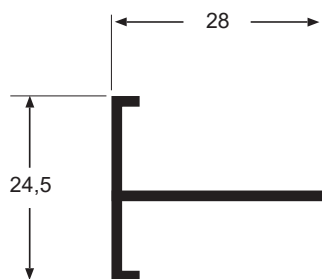

CM-008
0,170 kg/mt

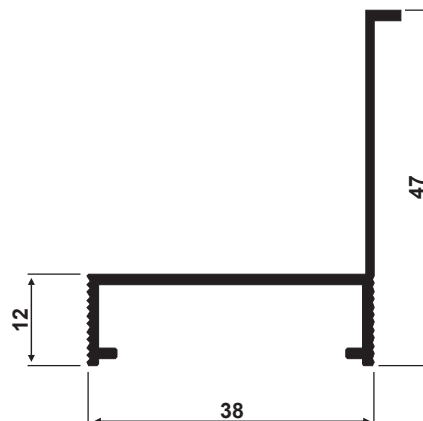

CM-098
0,326 Kg/m



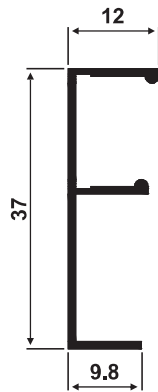

MP-347
0,184 kg/m



MP-055
0,277 kg/m

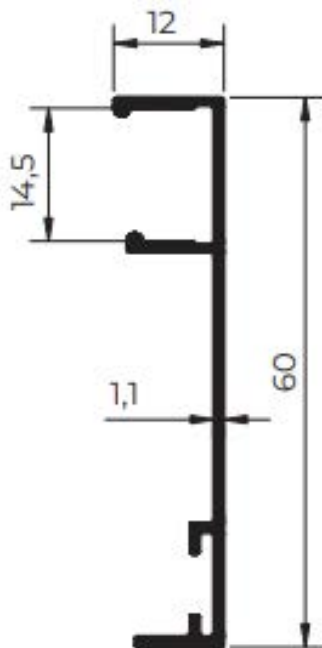

MP-060
0,300 kg/mt

RODAPÉ

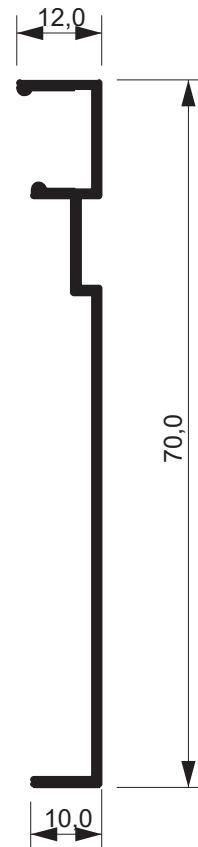

ROD-002
0,332 kg/mt



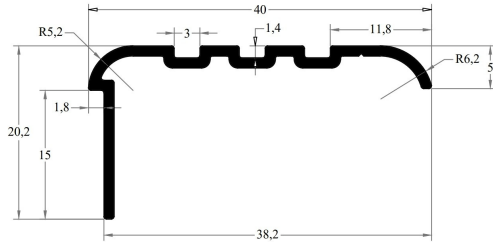

ME-015
0,220 kg/mt

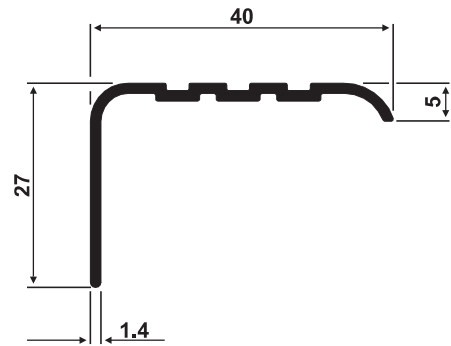

ME-013
0,253 Kg/m

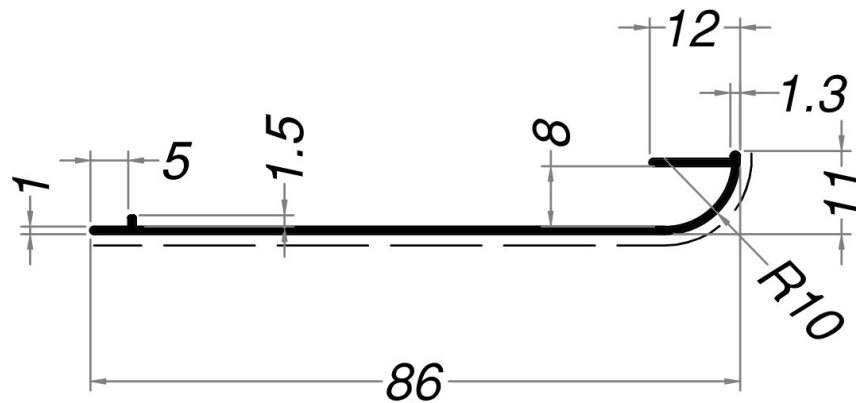

PI-084
0,282 kg/mt

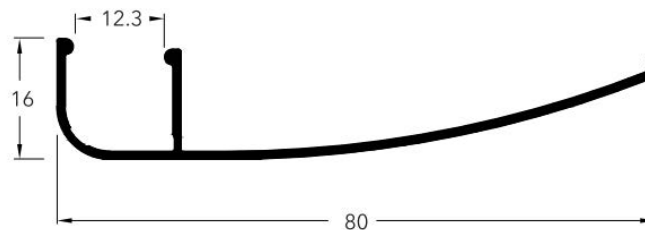

RM-021
0,315 kg/mt



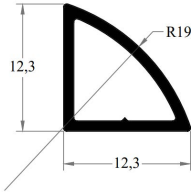

DV-023

0,105 kg/mt
Acabamento Meia Lua

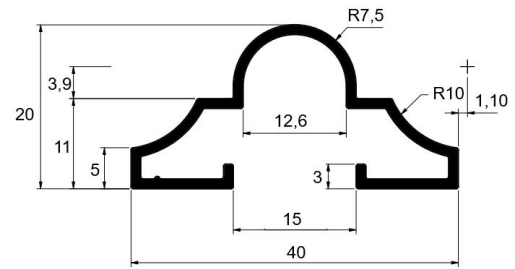

Moldura

POR-0258
0,294 kg/mt

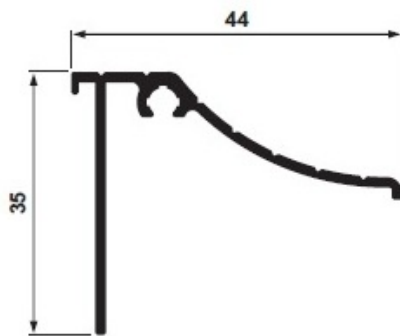

CM-169

0,409 kg/mt
Arremate Piso com olhal

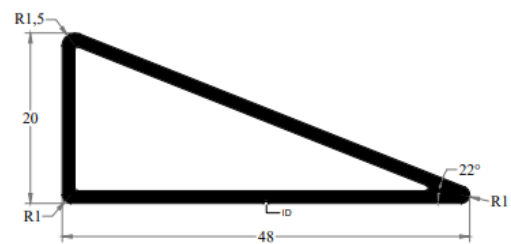

DV-024

0,464 kg/mt
Acabamento Arremate



Trilho superior Camarão

CA-001

0,900 kg/mt

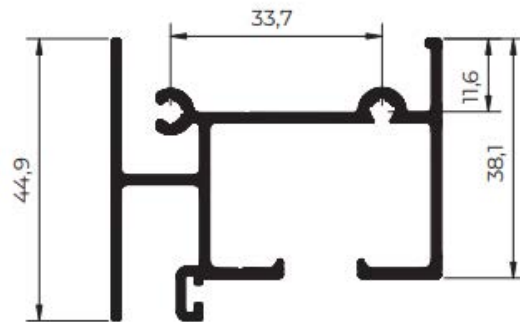

Trilho Inferior Camarão

CA-002

0,613 kg/mt

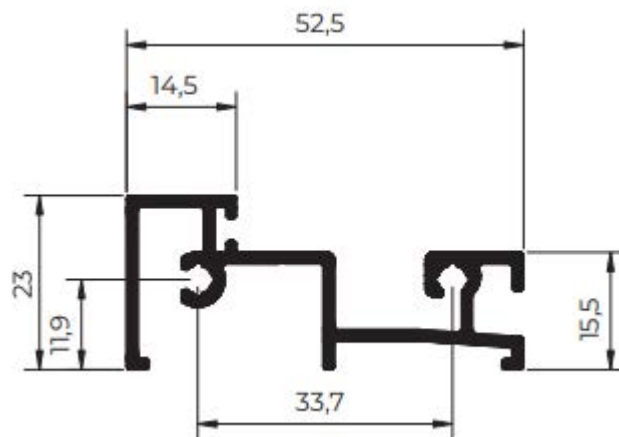

Marco lateral Camarão

CA-003

0,429 kg/mt

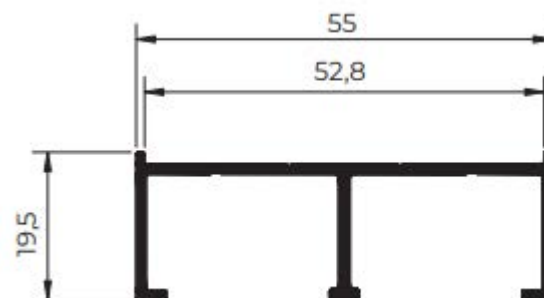

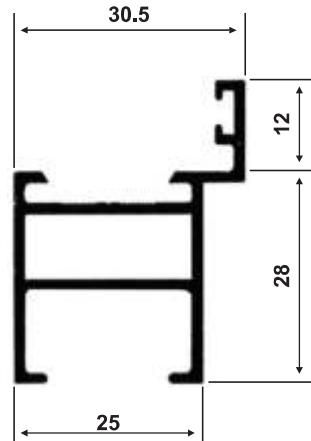

25-540
25-540
0,528 Kg/m

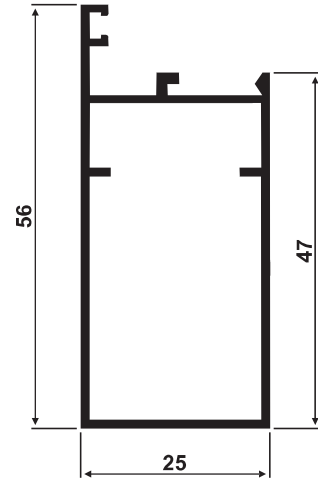

25-504
25-504
0,548 Kg/m

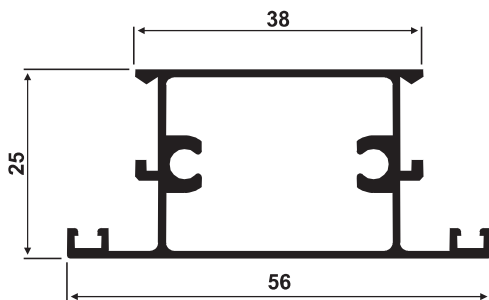

25-508
25-508
0,616 Kg/m

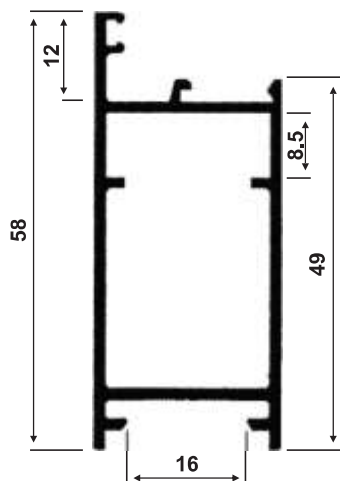

25-542
25-542
0,626 Kg/m

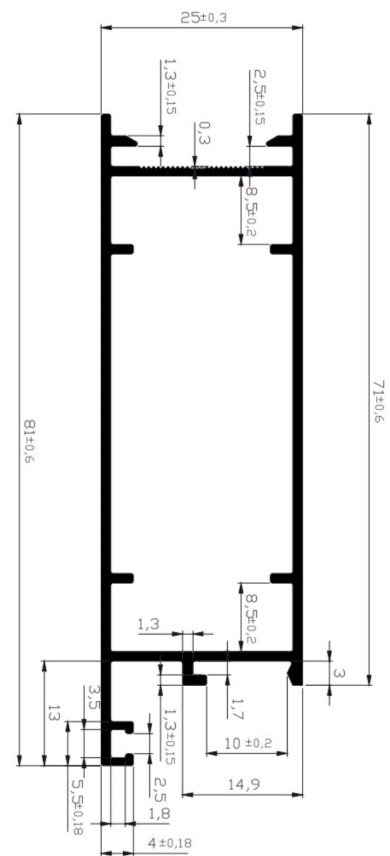

25-543
0,728 kg/m

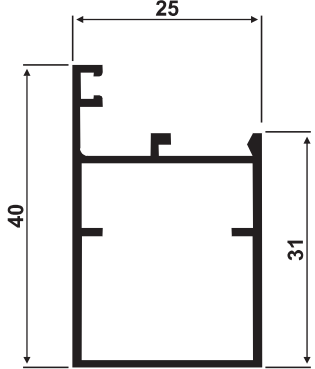
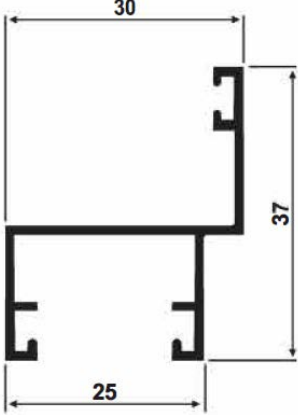
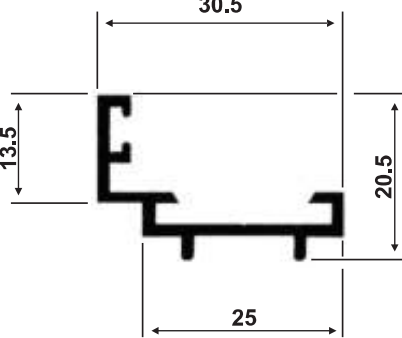
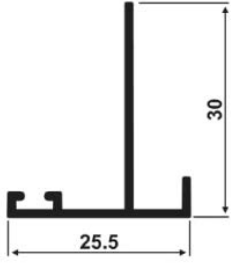
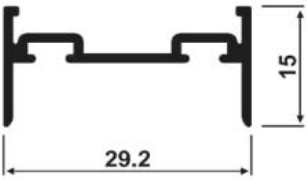
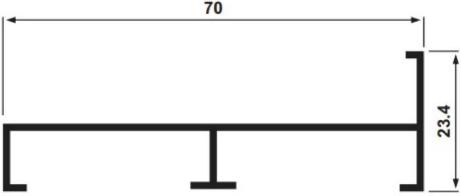
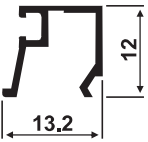
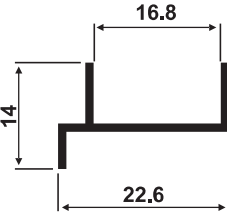
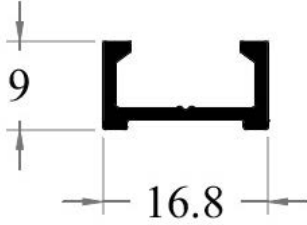

 <p>25-016 25-016 0,412 Kg/m</p>	 <p>25-002 0,324 Kg/m</p>	
 <p>25-548 25-548 0,269 Kg/m</p>	 <p>25-677 0,188 kg/m</p>	
 <p>25-021 0,224 kg/m</p>	 <p>25-514 0,409 kg/m</p>	
 <p>BG-001 BG-001 0,100 Kg/m</p>	 <p>DS-036 DS-036 0,129 kg/m</p>	 <p>CL-050 0,133 kg/mt</p>



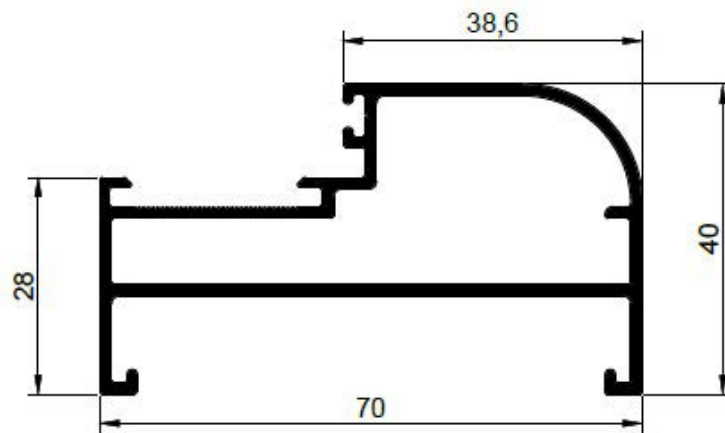

30-035
0,949 kg/m



LINHA 30

PORTA DE GIRO



<p>30-023 30-023 0,546 Kg/m</p>	<p>30-034 30-034 0,267 Kg/m</p>	<p>30-025 0,718 Kg/m</p>	
<p>30-026 0,780 kg/mt</p>	<p>30-377 1,081 Kg/m</p>	<p>30-082 1,086 kg/mt</p>	<p>30-030 1,092 Kg/m</p>
<p>BG-010 0,115 Kg/m</p>			



LINHA 42

PORTA DE GIRO

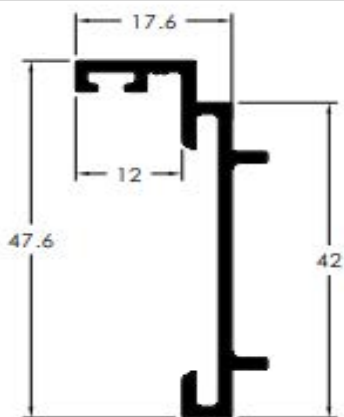

42-014
0,370kg/m

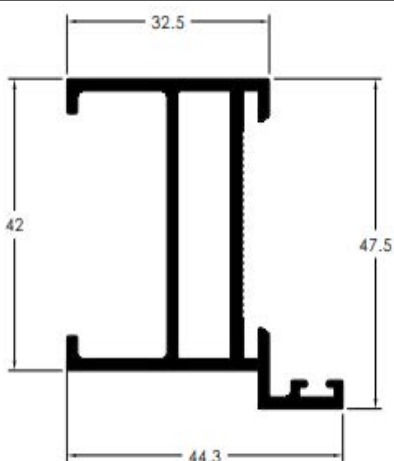

42-012
0,853kg/m

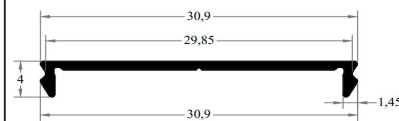

42-048
0,097kg/m

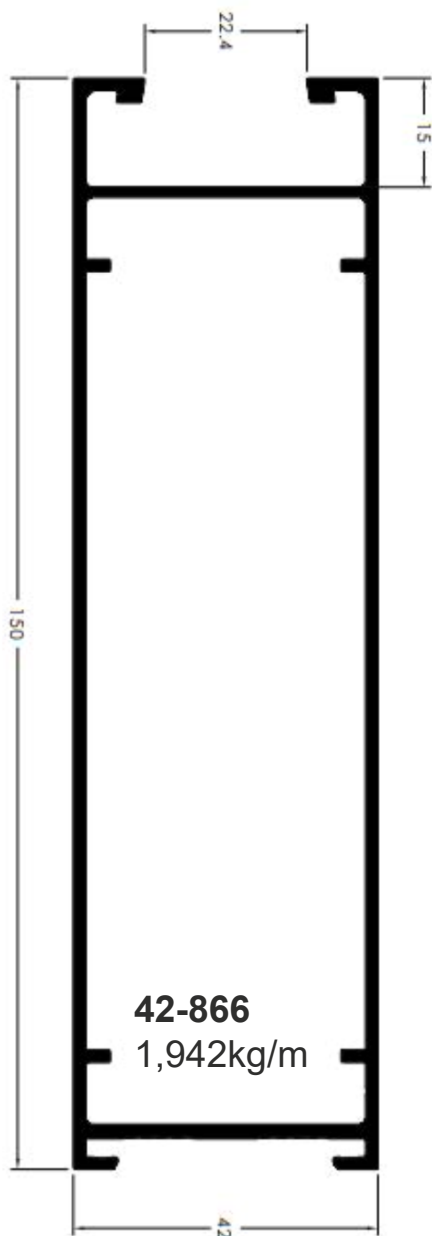

42-866
1,942kg/m

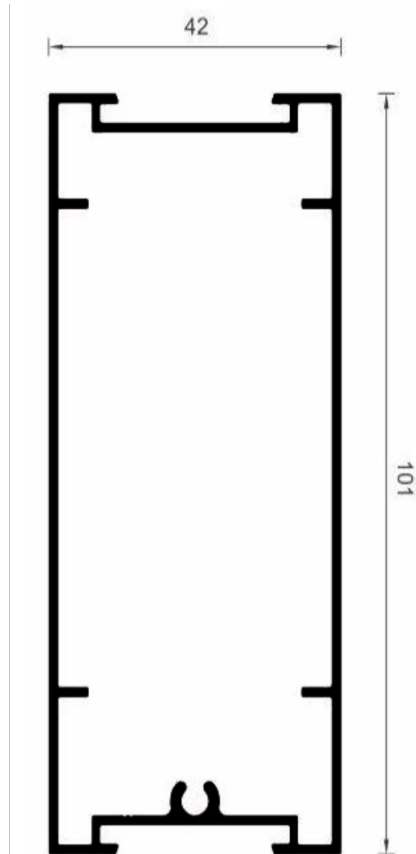

POR-0219
1,186kg/m

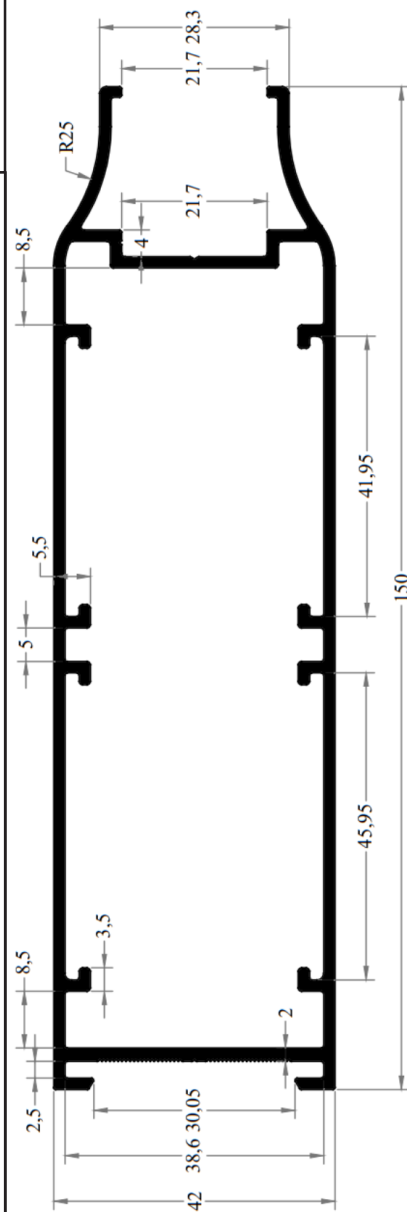

42-050
1,918kg/m

LINHA 42

PORTA DE GIRO

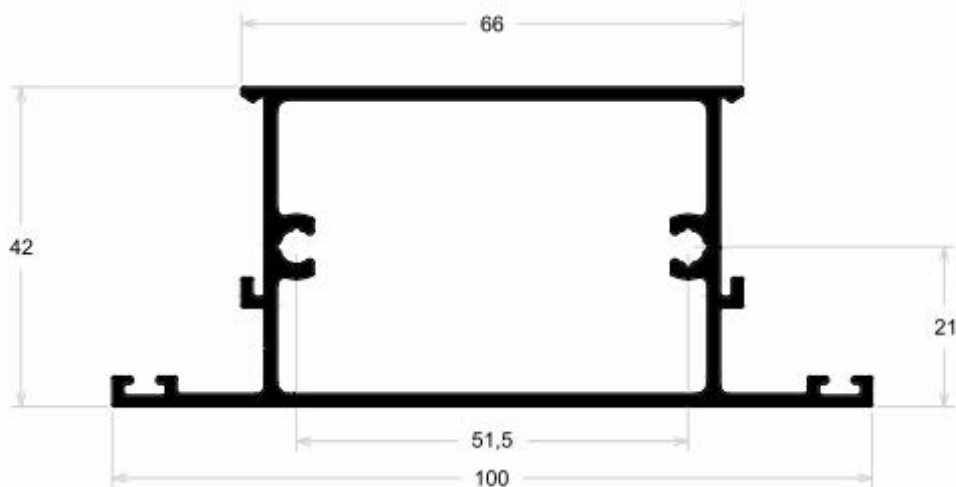

Travessa 100mm

42-007

1,331kg/m

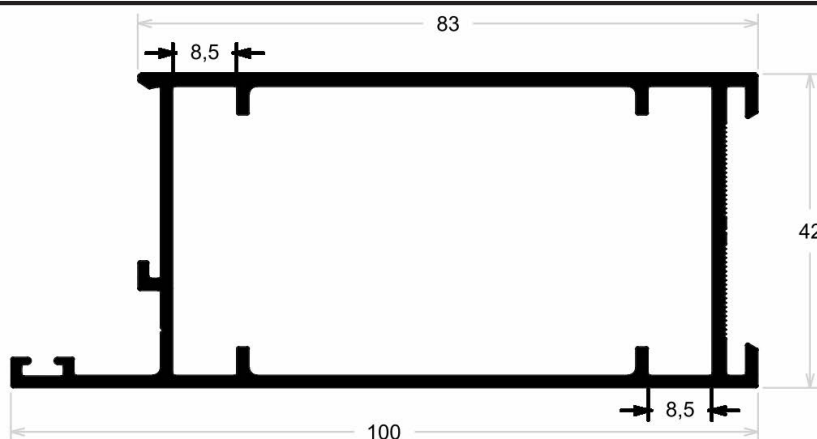

Folha Porta de Giro

42-032

1,375kg/m

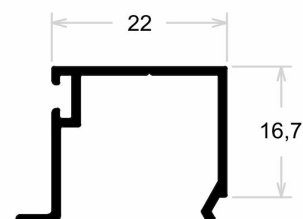

Baguete Perimetral

BG-037

0,208kg/m

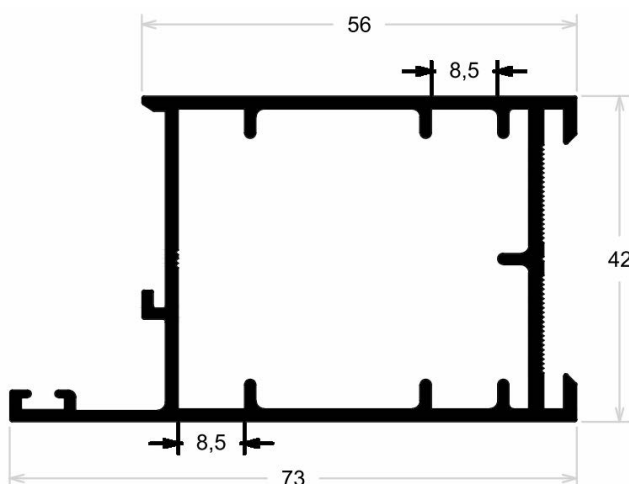

Folha Porta de Giro

42-035

1,156kg/m

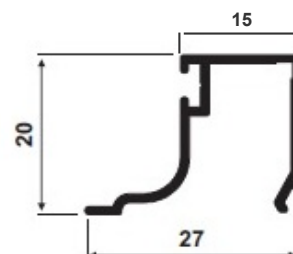

Baguete Perimetral

BG-023

0,202kg/m



LINHA 42

PORTA DE GIRO

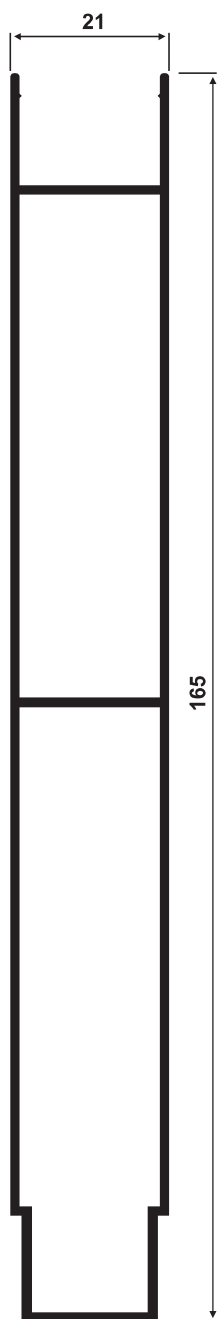

LB-165
1,354 kg/m

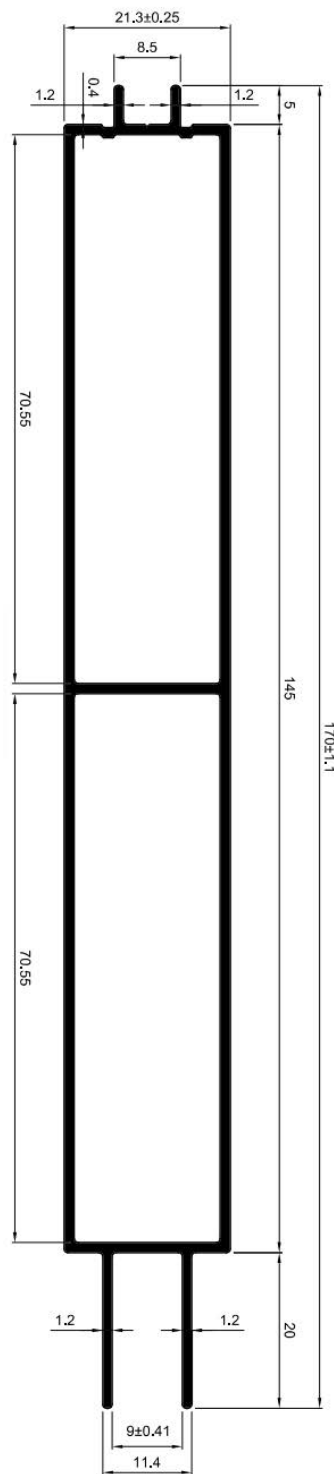

LB-042
1,382 kg/mt

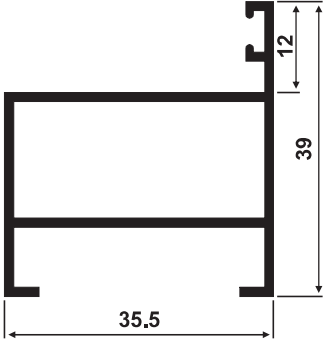
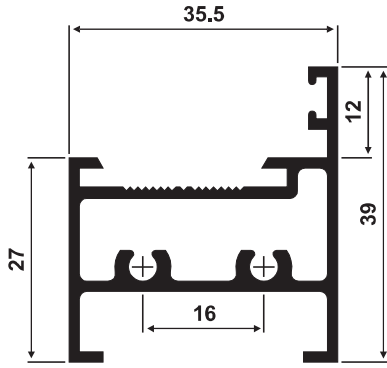
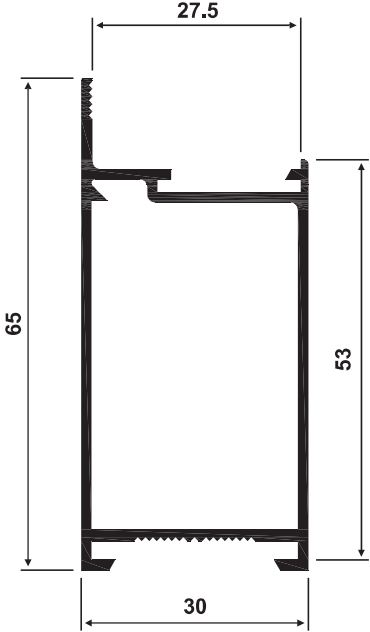
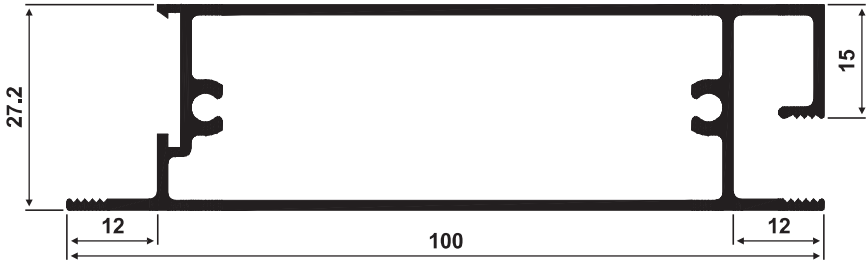
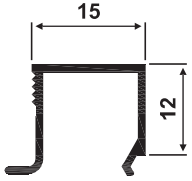
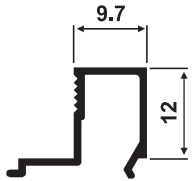
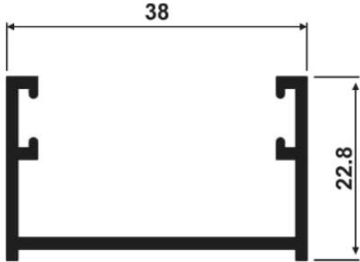

 <p>ME-073 ME-073 0,473 kg/m</p>	 <p>ME-074 ME-074 0,653 kg/m</p>	 <p>ME-075 ME-075 0,657 kg/m</p>
 <p>ME-078 ME-078 1,045 kg/m</p>		
 <p>ME-079 0,132 kg/m</p>	 <p>ME-086 0,132 Kg/m</p>	
 <p>ME-024 0,360 kg/m</p>		



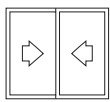

MARCO SUPERIOR
CORRER / 2

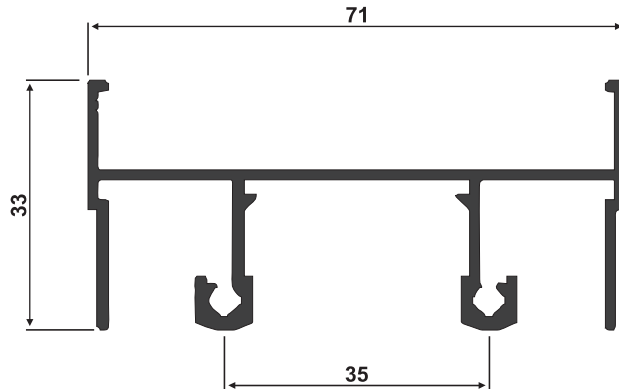

SU-001
0,738 Kg/m

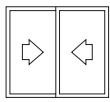

MARCO INFERIOR
CORRER / 2

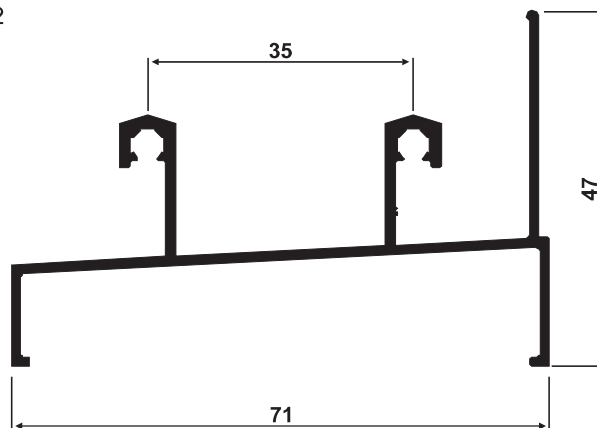

SU-002
0,683 Kg/m

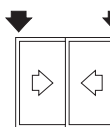

MARCO LATERAL
CORRER / 2

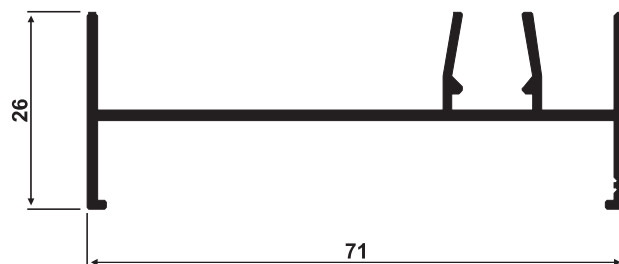

SU-003
0,509 Kg/m



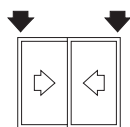

**MARCO LATERAL
CORRER / 2**
com contra fecho

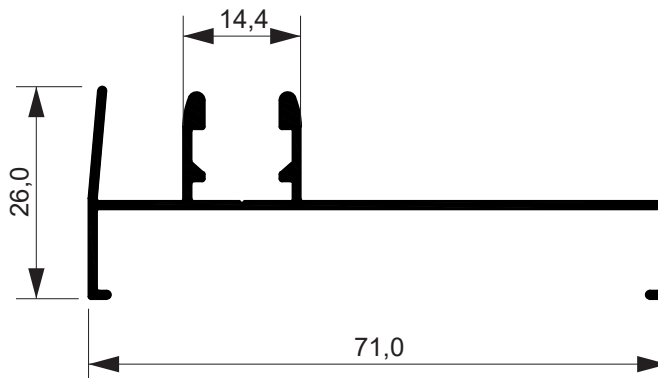

SU-303
0,453 kg/mt

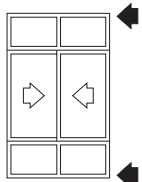

**MARCO BANDEIRA PEITORIL
CORRER / 2**

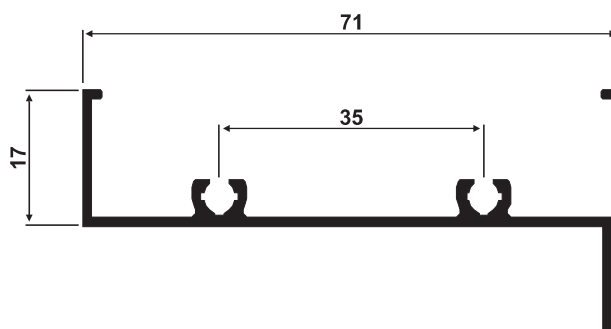

SU-004
0,475 Kg/m

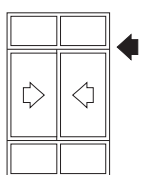

**TRAVESSA BANDEIRA / MARCO
CORRER / 2**

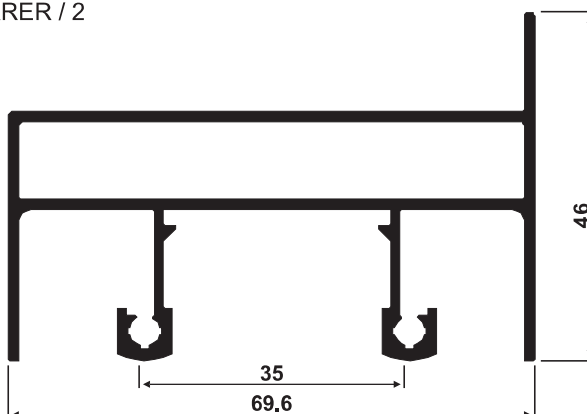

SU-005
1,108 Kg/m



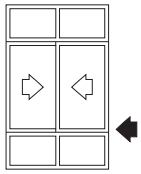

TRAVESSA PEITORIL / MARCO CORRER / 2

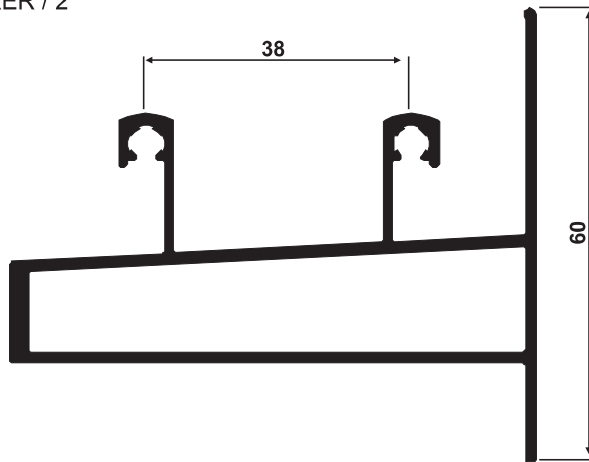

SU-006
1,085 Kg/m

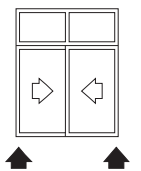

MARCO LATERAL CORRER / 2

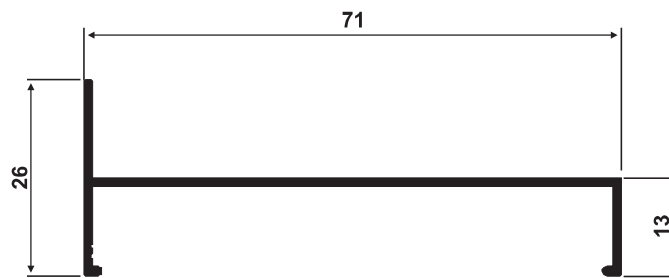

SU-007
0,371 Kg/m

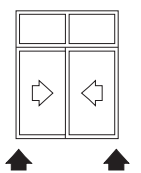

COMPLEMENTO / MARCO LATERAL CORRER

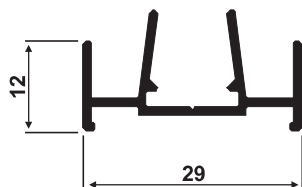

SU-291
0,250 Kg/m

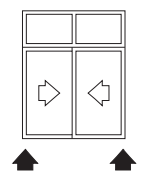

COMPLEMENTO / MARCO LATERAL CORRER

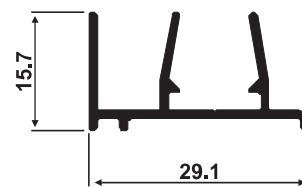

SU-008
0,234 Kg/m



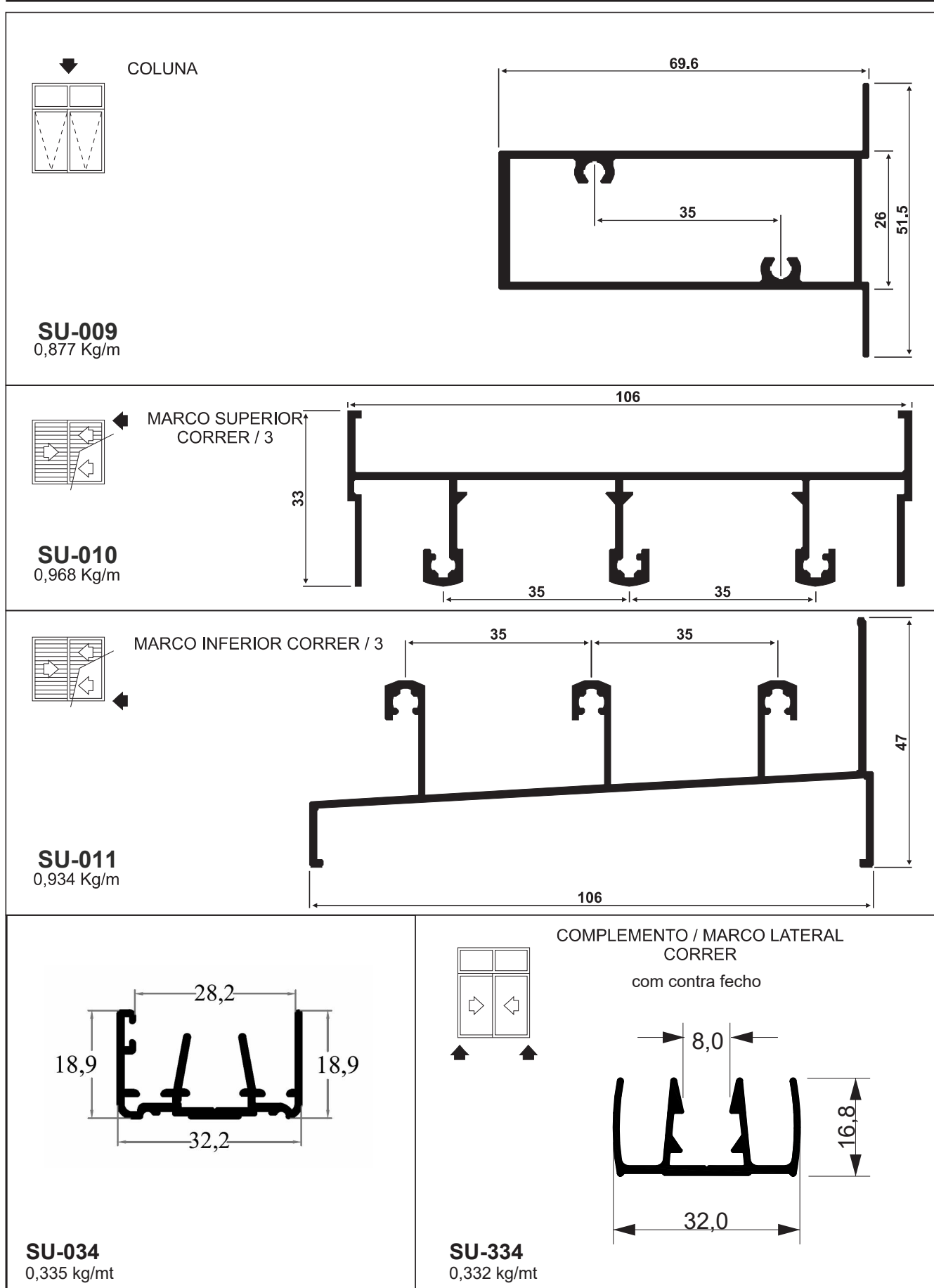

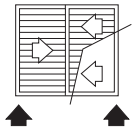

MARCO LATERAL
CORRER / 3

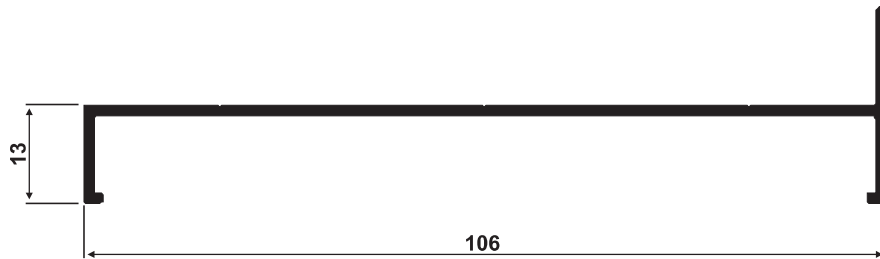

SU-012
0,509 Kg/m

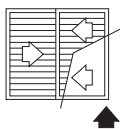

MARCO LATERAL
CORRER / 3

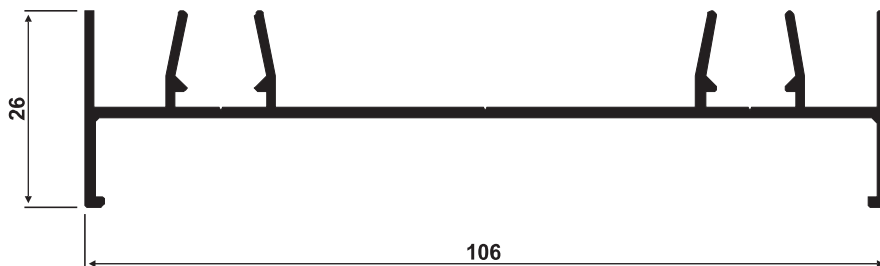

SU-013
0,736 Kg/m

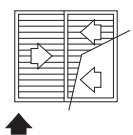

MARCO LATERAL
CORRER / 3

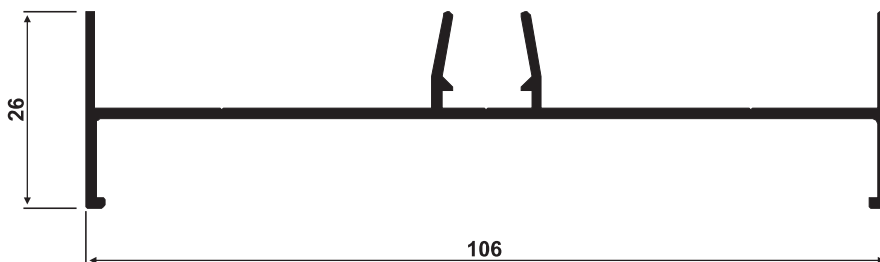

SU-014
0,639 Kg/m



MARCO SUPERIOR / CORRER / VENEZIANA CAMARÃO

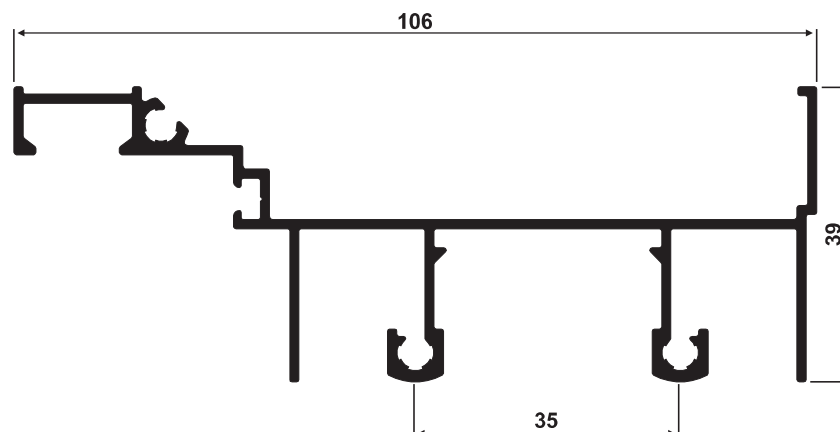
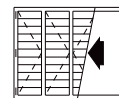

SU-024
0,959 Kg/m

MARCO INFERIOR / CORRER / VENEZIANA CAMARÃO

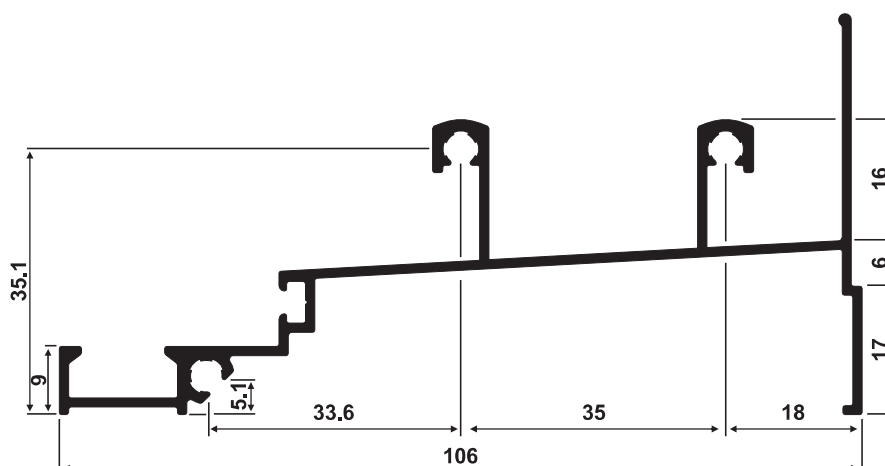

SU-025
0,919 Kg/m



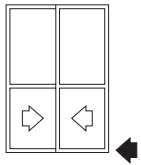

MARCO INFERIOR
CORRER / 2

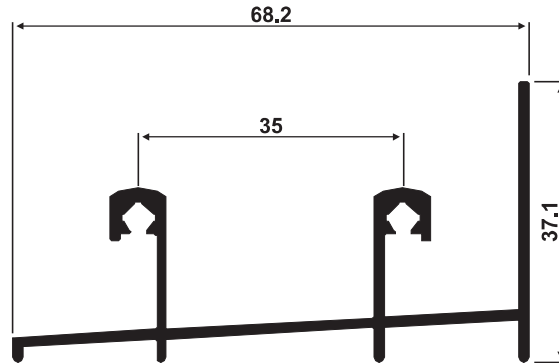

SU-228
0,688 Kg/m

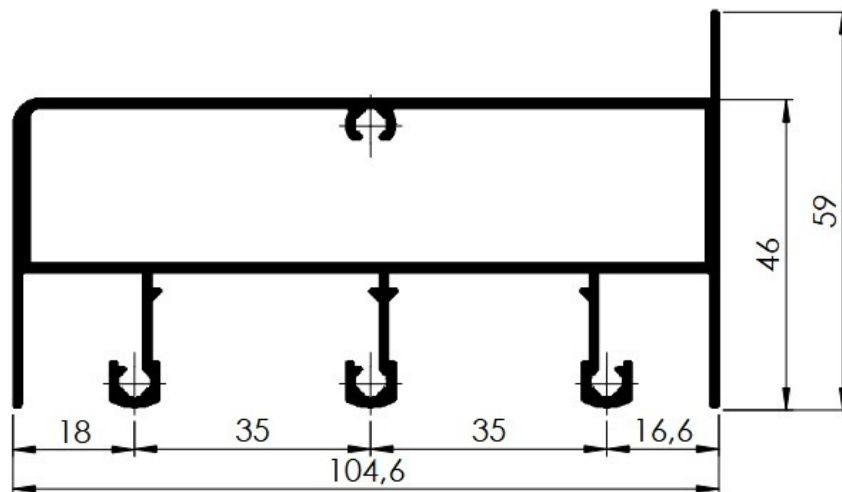

SU-019
1,678 Kg/m

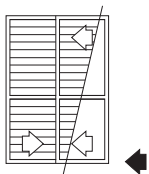

MARCO INFERIOR
CORRER / 3

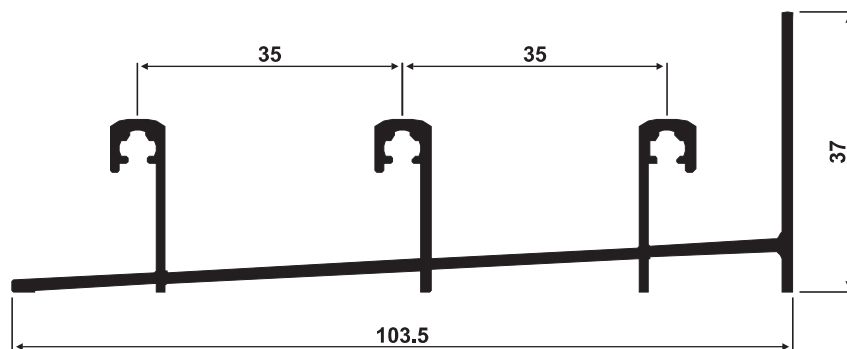

SU-230
0,936 Kg/m



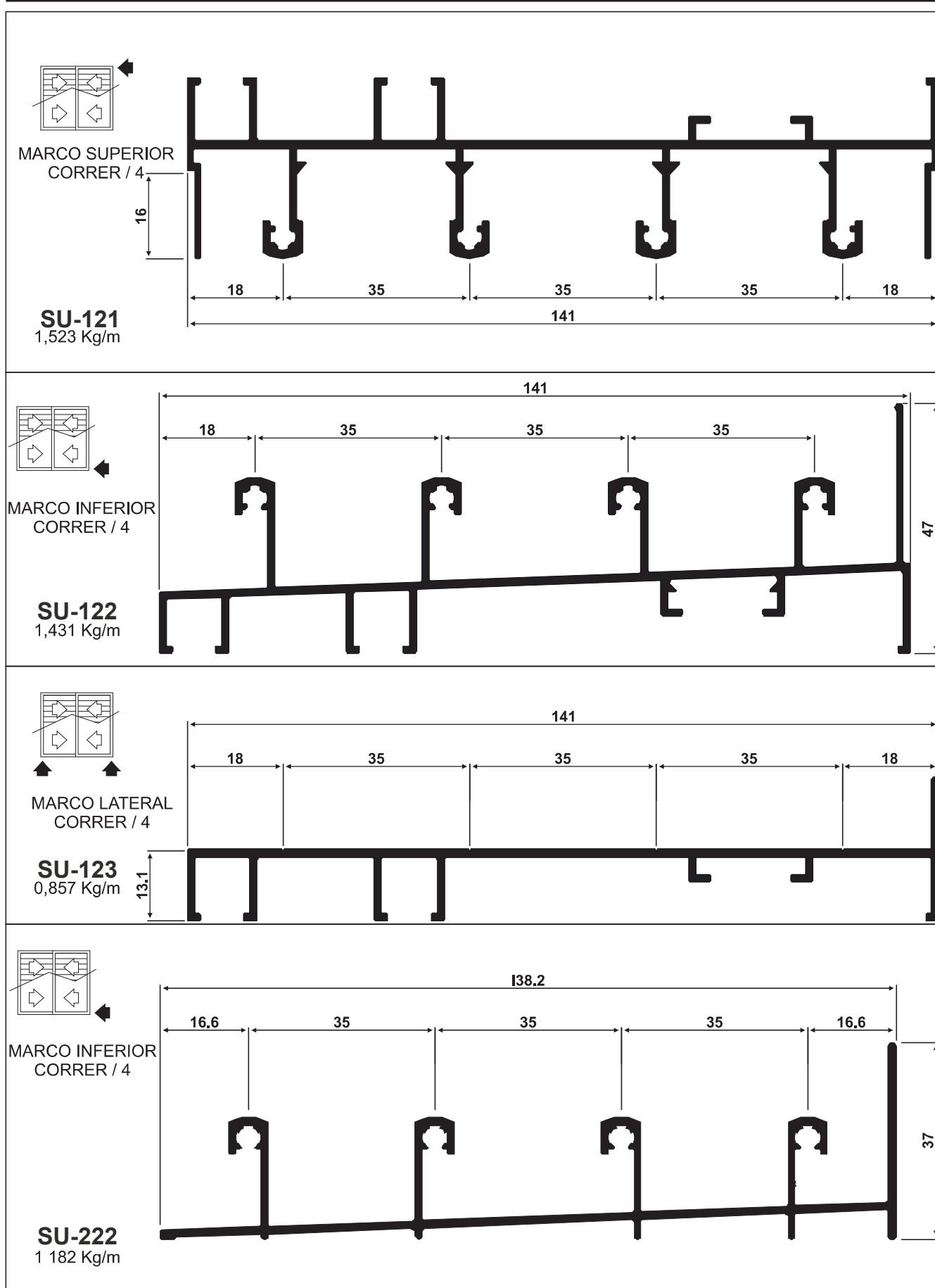

Linha *Nobile 2.9*
5 PLANOS

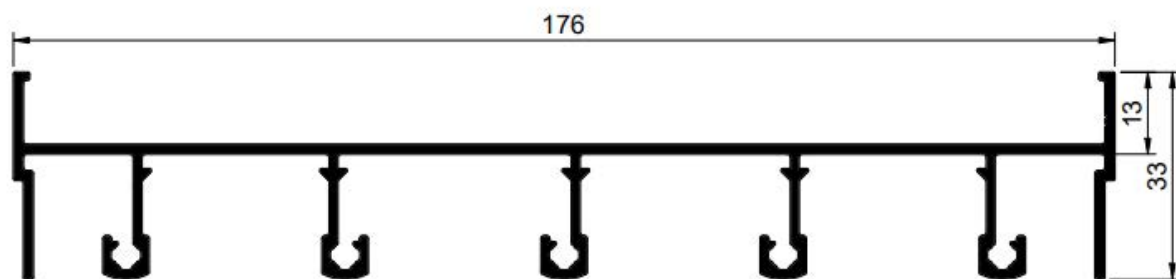

SU-605
1,749 kg/m

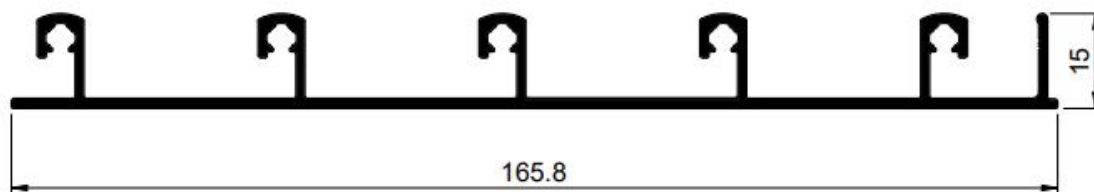

SU-606
1,282 kg/m

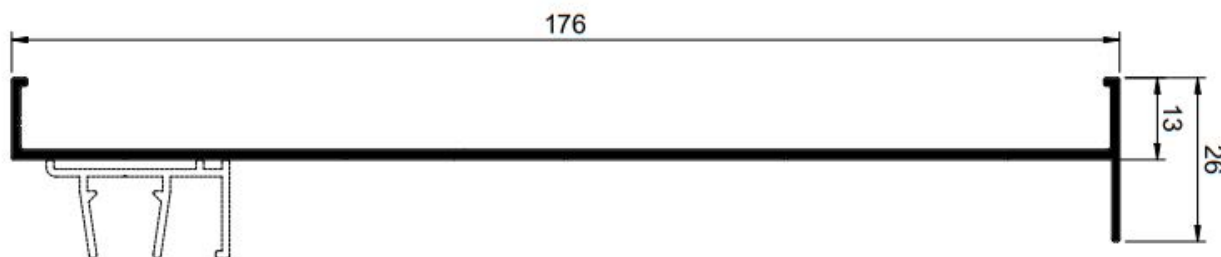

SU-607
0,898 kg/m

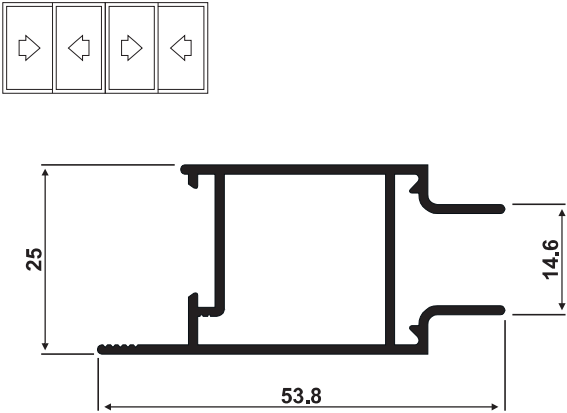
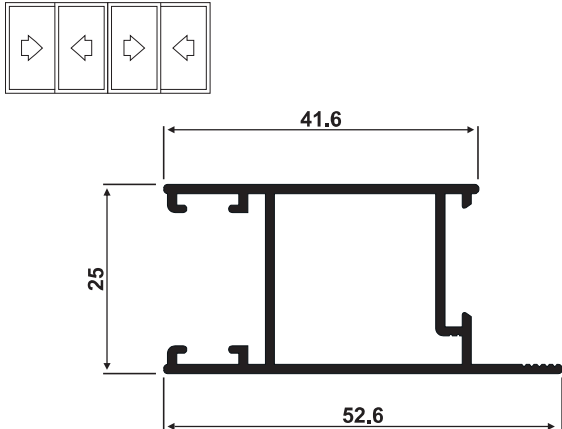
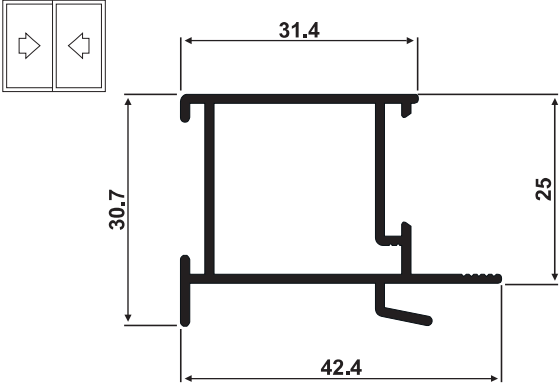
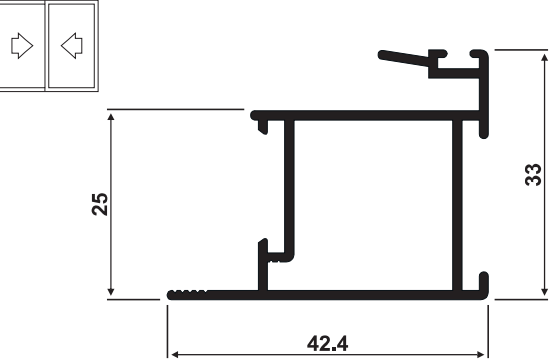
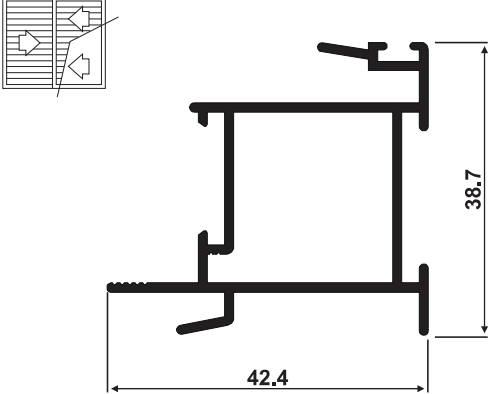
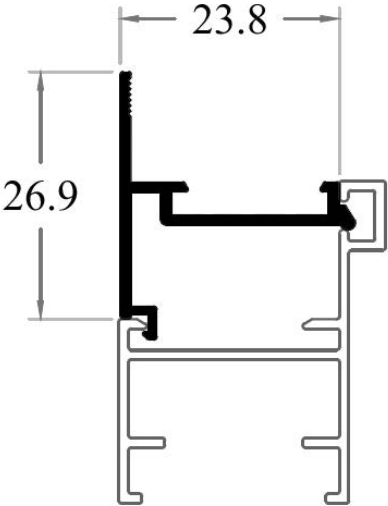

<p style="text-align: center;">↓</p> <p style="text-align: center;">MONTANTE CENTRAL</p>  <p>SU-192 0,498 Kg/m</p>	<p style="text-align: center;">↓ ↓ ↓</p> <p style="text-align: center;">MONTANTE DA FOLHA</p>  <p>SU-039 0,506 Kg/m</p>
<p style="text-align: center;">↓</p> <p style="text-align: center;">MONTANTE MÃO DE AMIGO</p>  <p>SU-040 0,458 Kg/m</p>	<p style="text-align: center;">↓</p> <p style="text-align: center;">MONTANTE MÃO DE AMIGO</p>  <p>SU-041 0,485 Kg/m</p>
<p style="text-align: center;">↓</p> <p style="text-align: center;">MONTANTE MÃO DE AMIGO</p>  <p>SU-042 0,531 Kg/m</p>	 <p>SU-292 0,214 kg/mt</p>



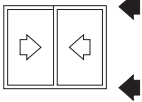

TRAVESSA / FOLHA

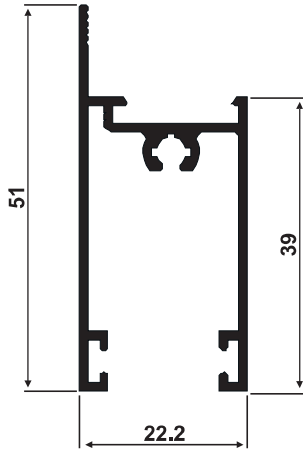

SU-053
0,488 Kg/m

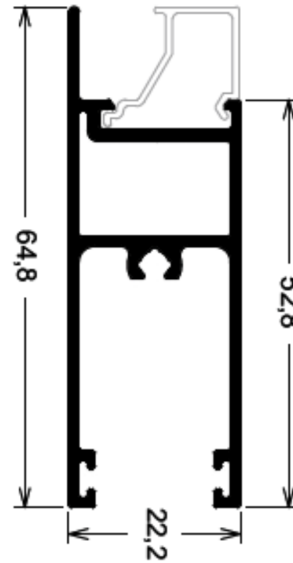

SU-246
0,678 kg/mt

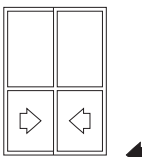

TRAVESSA INFERIOR / FOLHA

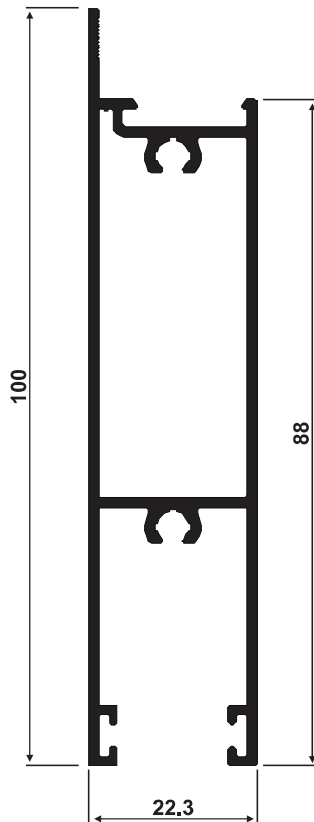

SU-225
0,968 Kg/m

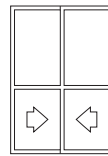

TRAVESSA INFERIOR / FOLHA

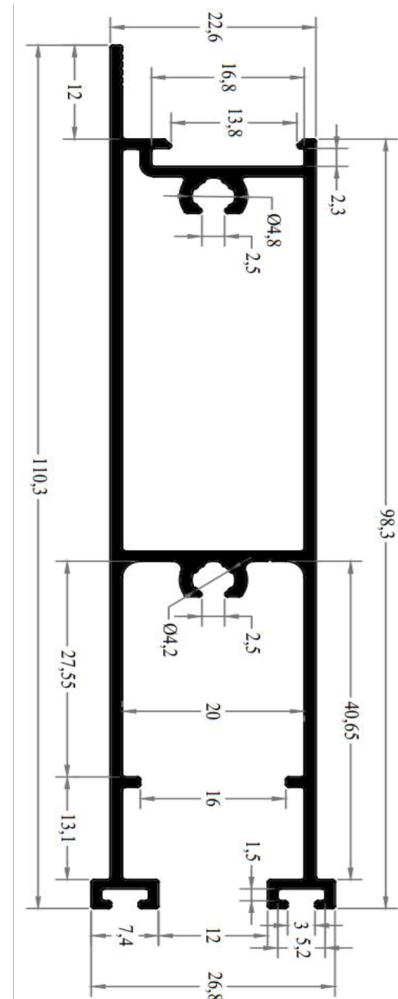

SU-247
1,064 kg/mt

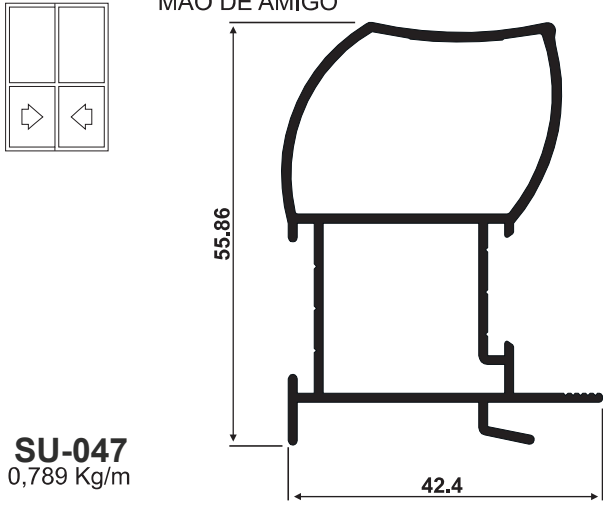
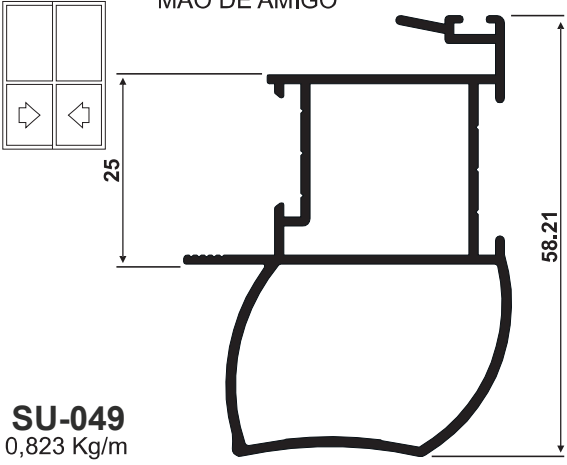
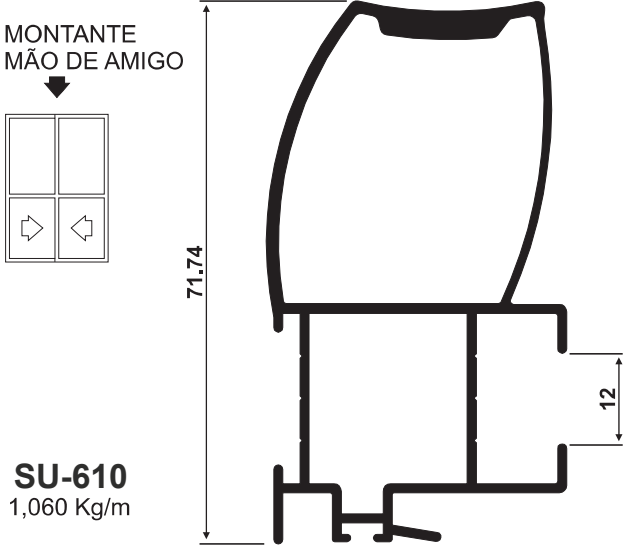
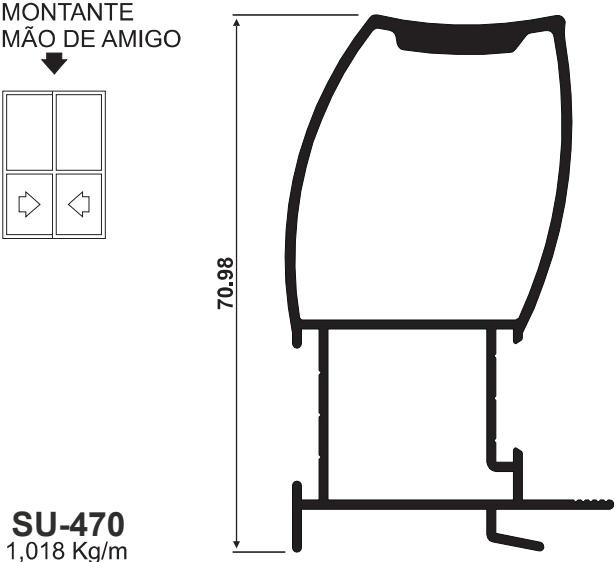
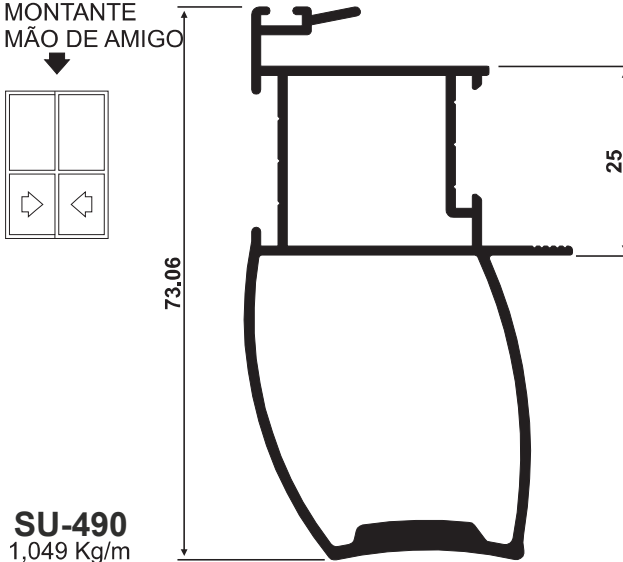
	<p>↓</p> <p>MONTANTE MÃO DE AMIGO</p>  <p>55.86</p> <p>42.4</p> <p>SU-047 0,789 Kg/m</p>
<p>↓</p> <p>MONTANTE MÃO DE AMIGO</p>  <p>25</p> <p>58.21</p> <p>SU-049 0,823 Kg/m</p>	<p>MONTANTE MÃO DE AMIGO</p> <p>↓</p>  <p>71.74</p> <p>12</p> <p>SU-610 1,060 Kg/m</p>
<p>MONTANTE MÃO DE AMIGO</p> <p>↓</p>  <p>70.98</p> <p>SU-470 1,018 Kg/m</p>	<p>MONTANTE MÃO DE AMIGO</p> <p>↓</p>  <p>73.06</p> <p>25</p> <p>SU-490 1,049 Kg/m</p>

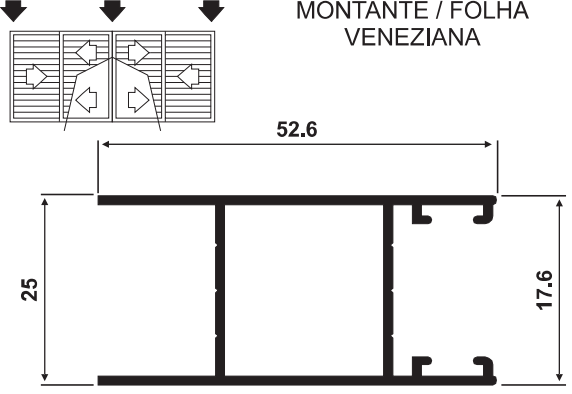
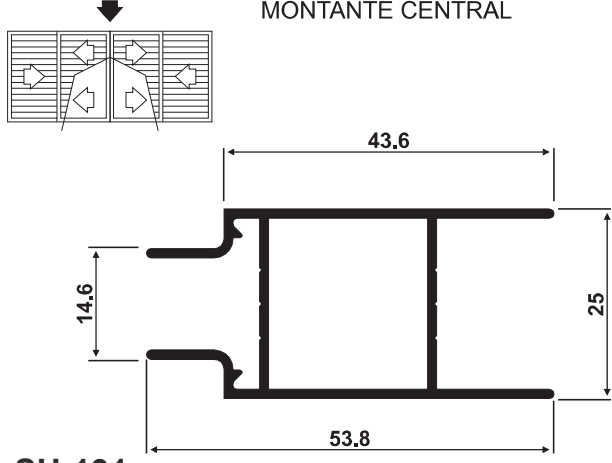
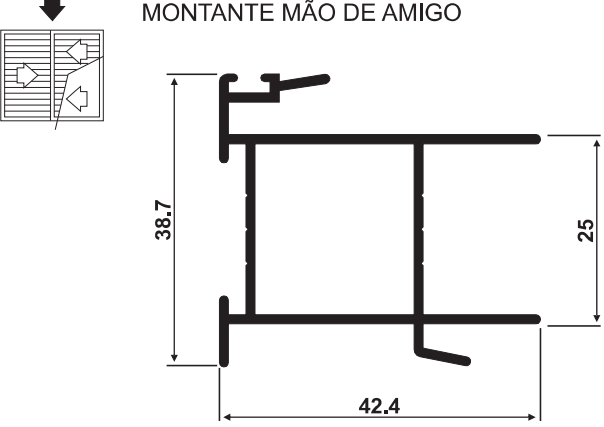
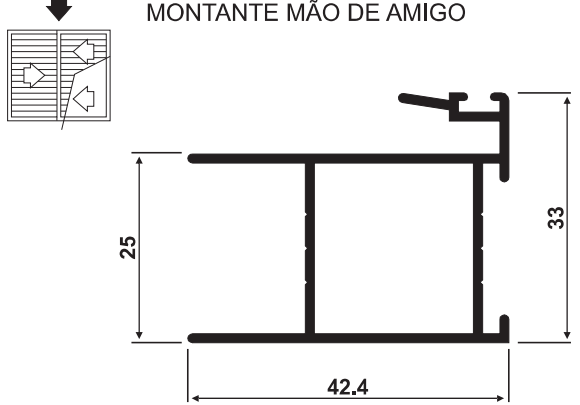
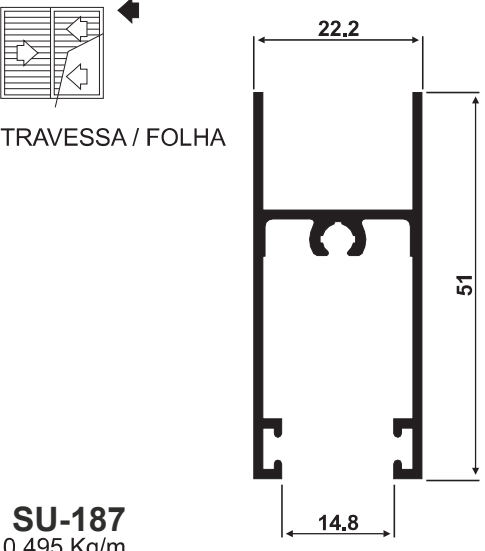
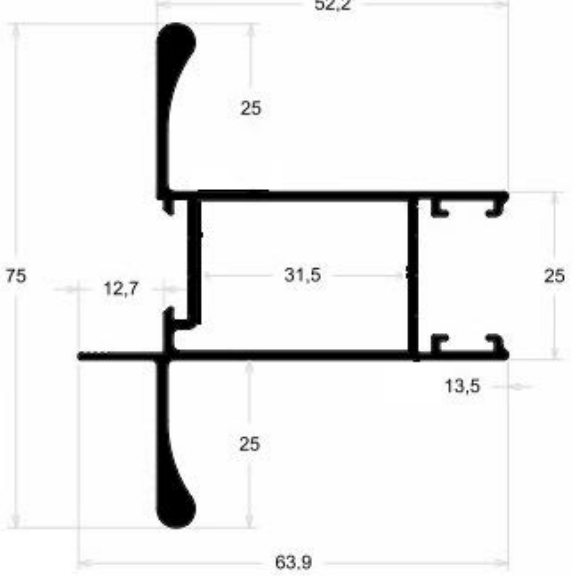

 <p>MONTANTE / FOLHA VENEZIANA</p> <p>52.6</p> <p>25</p> <p>17.6</p> <p>SU-068 0,509 Kg/m</p>	 <p>MONTANTE CENTRAL</p> <p>43.6</p> <p>14.6</p> <p>25</p> <p>53.8</p> <p>SU-191 0,514 Kg/m</p>
 <p>MONTANTE MÃO DE AMIGO</p> <p>38.7</p> <p>25</p> <p>42.4</p> <p>SU-069 0,547 Kg/m</p>	 <p>MONTANTE MÃO DE AMIGO</p> <p>25</p> <p>33</p> <p>42.4</p> <p>SU-070 0,494 Kg/m</p>
 <p>TRAVESSA / FOLHA</p> <p>22.2</p> <p>51</p> <p>14.8</p> <p>SU-187 0,495 Kg/m</p>	 <p>52.2</p> <p>25</p> <p>75</p> <p>12.7</p> <p>31.5</p> <p>25</p> <p>13.5</p> <p>25</p> <p>63.9</p> <p>SU-299 0,966 kg/m</p>

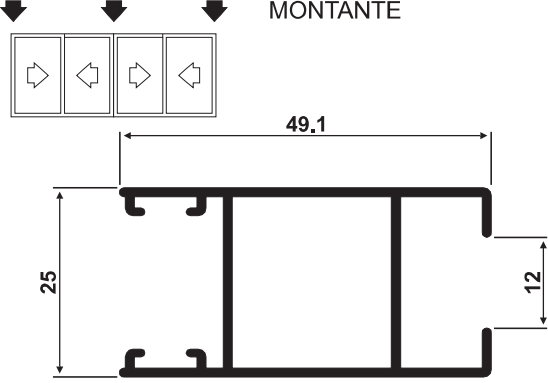
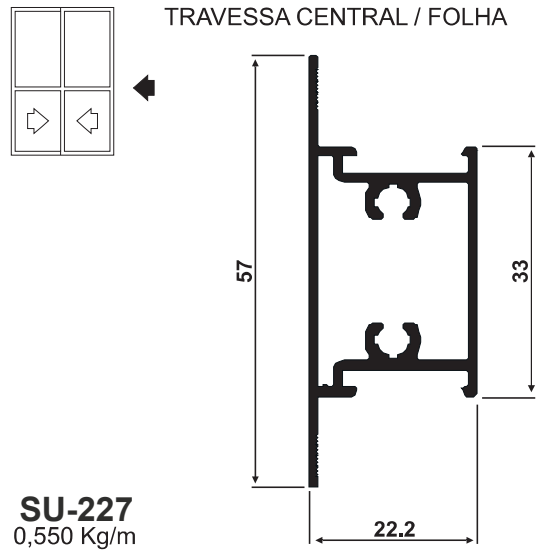
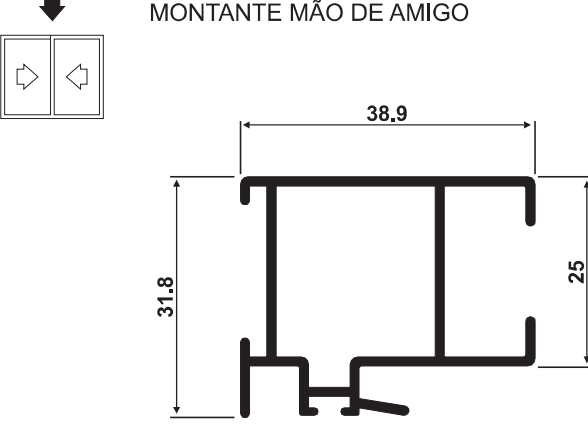
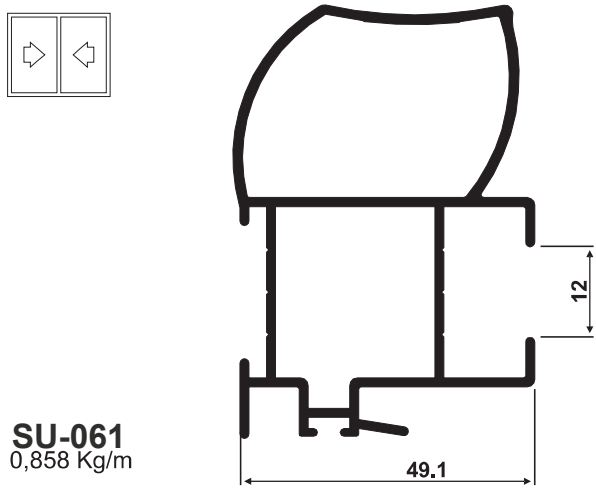
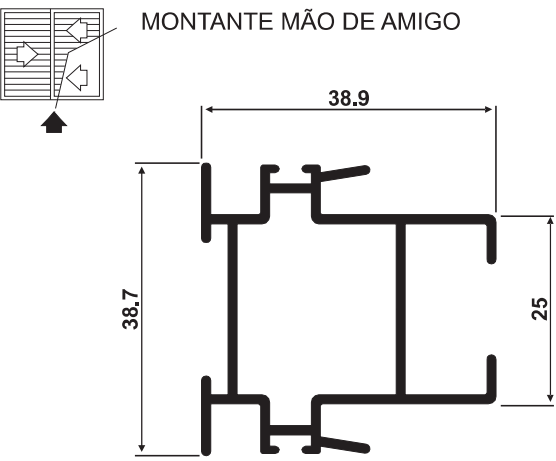
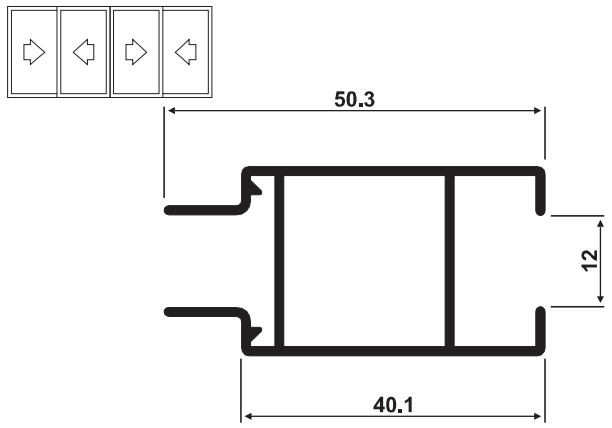

<p>↓</p> <p>MONTANTE</p>  <p>49,1</p> <p>25</p> <p>12</p> <p>SU-055 0,523 Kg/m</p>	<p>TRAVESSA CENTRAL / FOLHA</p>  <p>57</p> <p>33</p> <p>22,2</p> <p>SU-227 0,550 Kg/m</p>
<p>↓</p> <p>MONTANTE MÃO DE AMIGO</p>  <p>38,9</p> <p>31,8</p> <p>25</p> <p>SU-056 0,519 Kg/m</p>	<p>↓</p> <p>MONTANTE MÃO DE AMIGO</p>  <p>49,1</p> <p>12</p> <p>SU-061 0,858 Kg/m</p>
<p>MONTANTE MÃO DE AMIGO</p>  <p>38,9</p> <p>38,7</p> <p>25</p> <p>SU-057 0,599 Kg/m</p>	<p>↓</p> <p>MONTANTE CENTRAL</p>  <p>50,3</p> <p>12</p> <p>40,1</p> <p>SU-190 0,521 Kg/m</p>



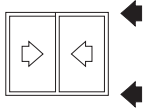

TRAVESSA / FOLHA

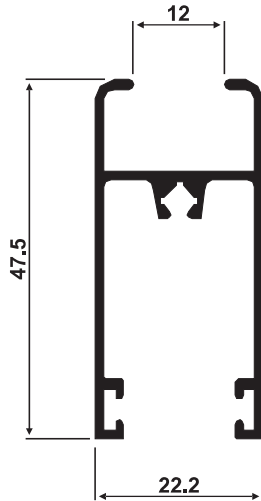

SU-186
0,489 Kg/m

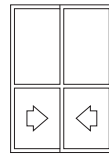

TRAVESSA CENTRAL / FOLHA

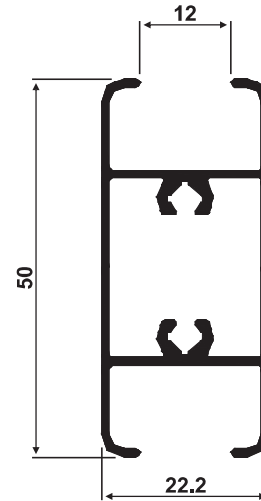

SU-188
0,569 Kg/m

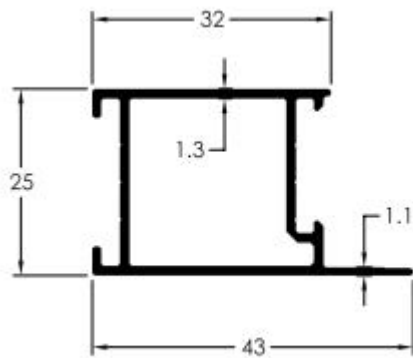

SU-120
0,452 kg/m

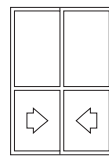

TRAVESSA INFERIOR / FOLHA

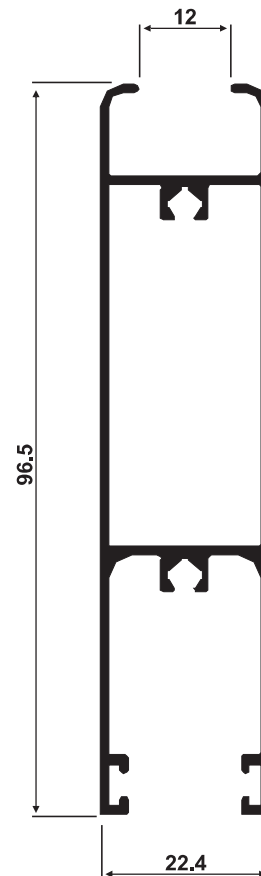

SU-226
0,987 Kg/m

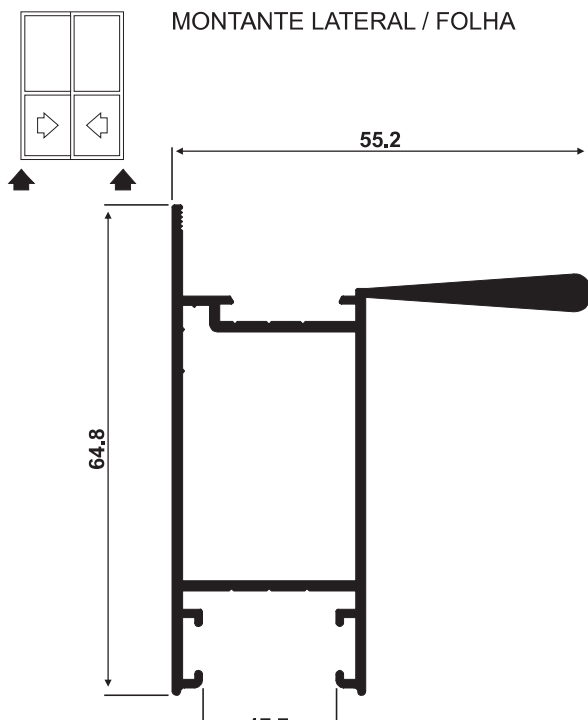
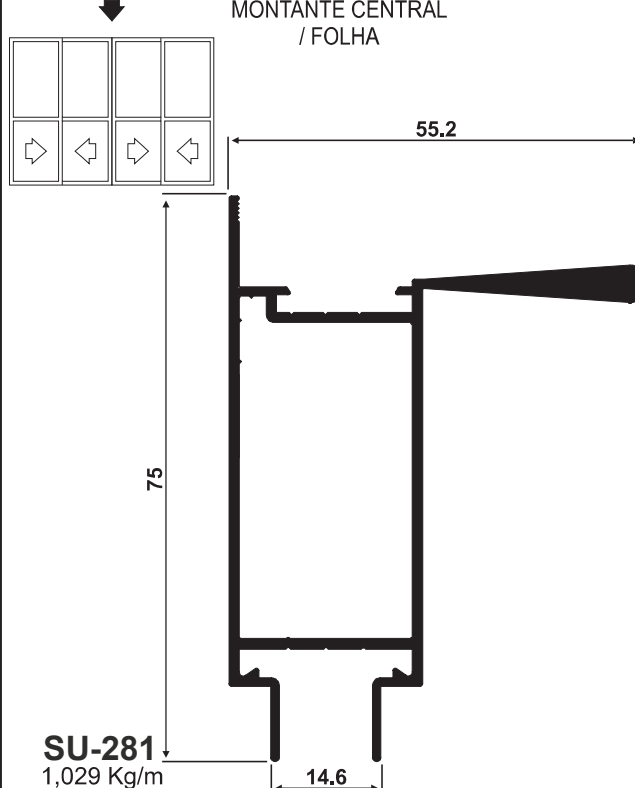
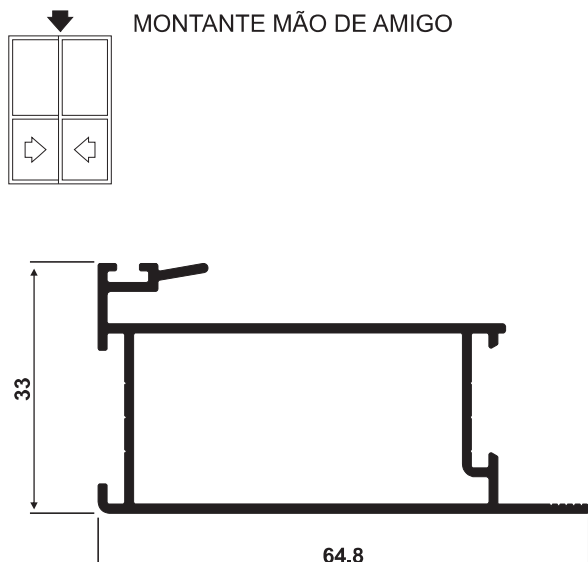
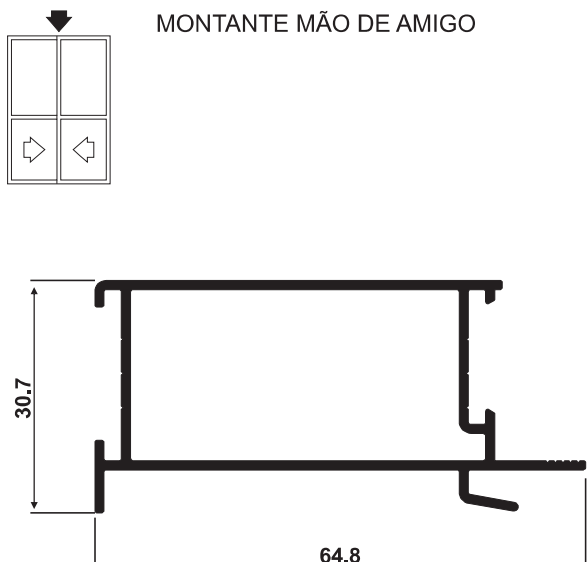

<p>MONTANTE LATERAL / FOLHA</p>  <p>SU-280 0,969 Kg/m</p>	<p>MONTANTE CENTRAL / FOLHA</p>  <p>SU-281 1,029 Kg/m</p>
<p>MONTANTE MÃO DE AMIGO</p>  <p>SU-242 0,683 Kg/m</p>	<p>MONTANTE MÃO DE AMIGO</p>  <p>SU-243 0,651 Kg/m</p>



MONTANTE LATERAL / FOLHA

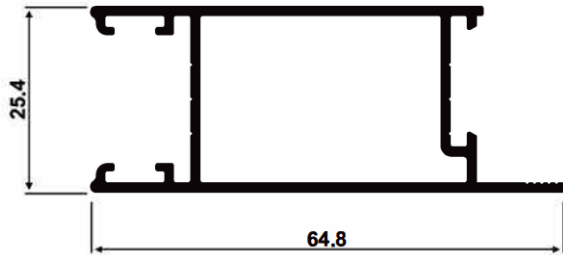
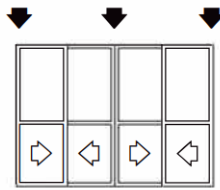

SU-245
0,676 Kg/m

MONTANTE CENTRAL / FOLHA

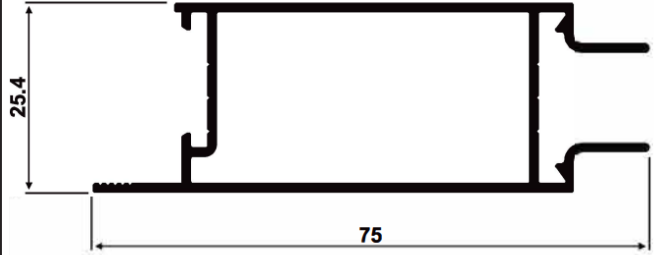
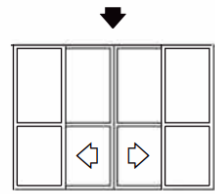

SU-244
0,682 Kg/m

MONTANTE LATERAL / FOLHA

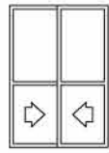

SU-238
0,669 Kg/m

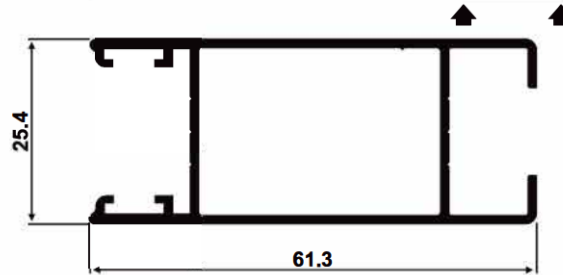

MONTANTE CENTRAL / FOLHA

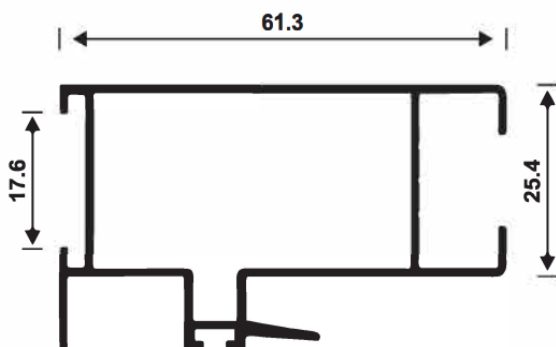
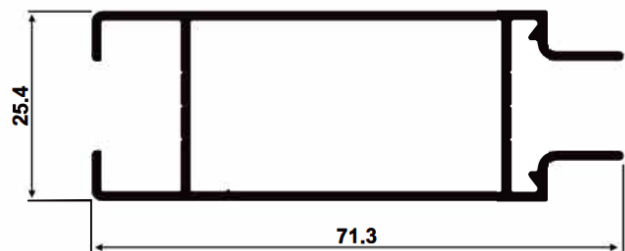
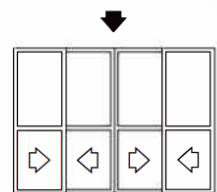

SU-239
0,696 Kg/m

SU-240
0,712 Kg/m

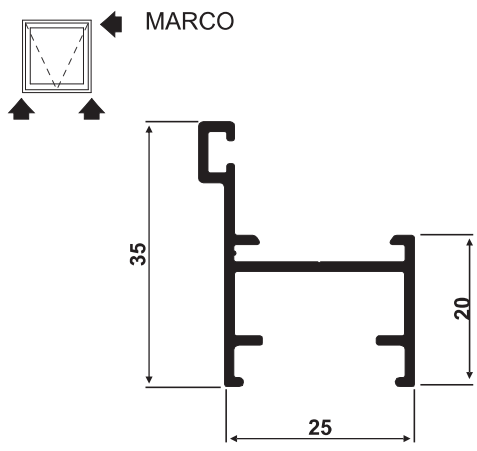
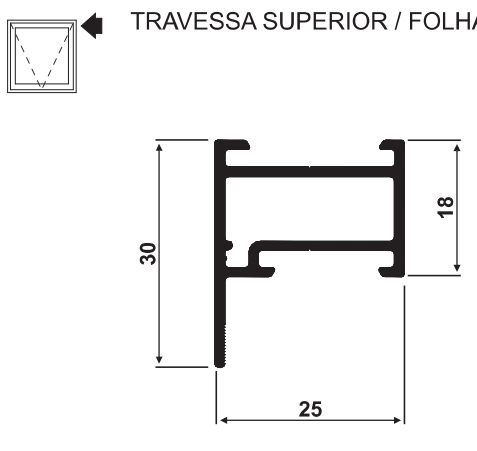
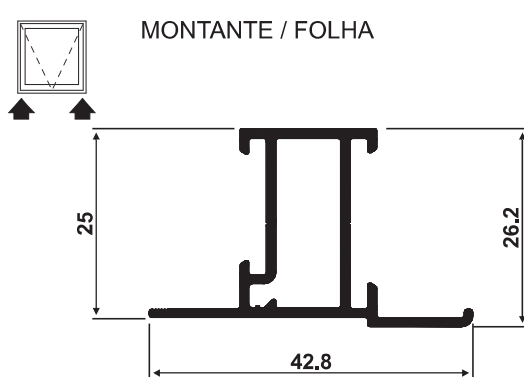
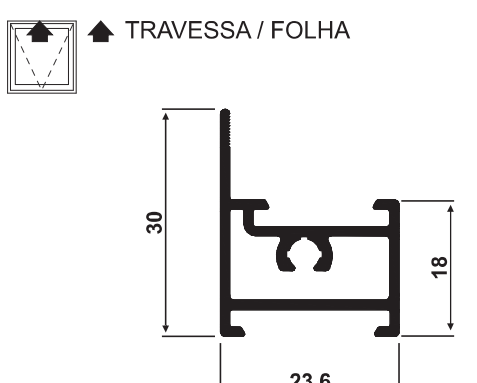
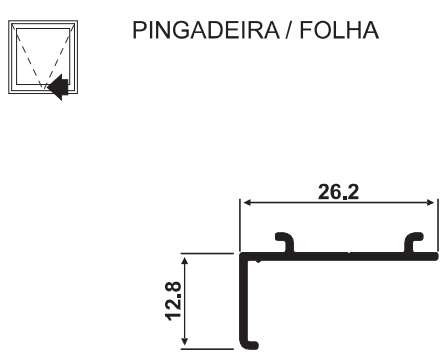
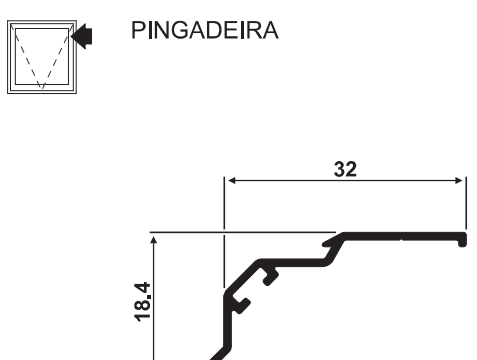

 <p>MARCO</p> <p>35</p> <p>25</p> <p>20</p> <p>SU-079 0,341 Kg/m</p>	 <p>TRAVESSA SUPERIOR / FOLHA 45°</p> <p>30</p> <p>25</p> <p>18</p> <p>SU-080 0,343 Kg/m</p>
 <p>MONTANTE / FOLHA</p> <p>25</p> <p>42.8</p> <p>26.2</p> <p>SU-081 0,389 Kg/m</p>	 <p>TRAVESSA / FOLHA</p> <p>30</p> <p>23.6</p> <p>18</p> <p>SU-082 0,365 Kg/m</p>
 <p>PINGADEIRA / FOLHA</p> <p>12.8</p> <p>26.2</p> <p>SU-084 0,125 Kg/m</p>	 <p>PINGADEIRA</p> <p>18.4</p> <p>32</p> <p>SU-083 0,144 Kg/m</p>



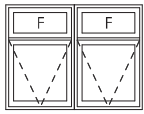

TRAVESSA / MARCO

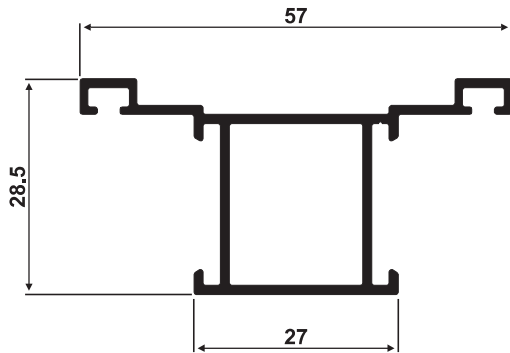

SU-085
0,485 Kg/m

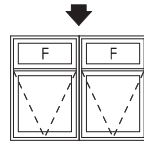

COLUNA / MARCO

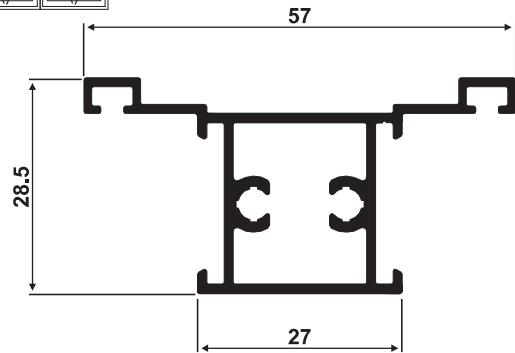

SU-086
0,581 Kg/m

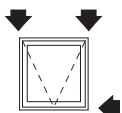

MONTANTE / TRAVESSA FOLHA 45°

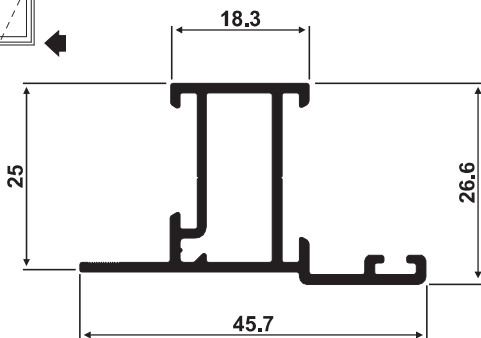

SU-200
0,418 Kg/m

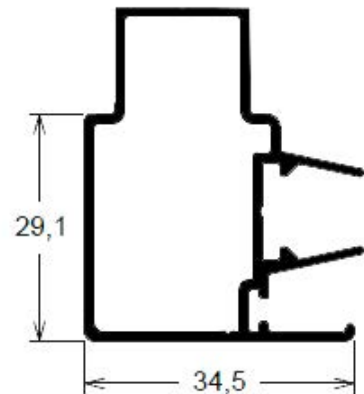

SU-038
0,527 Kg/m

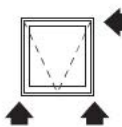

MARCO P/ GRADE

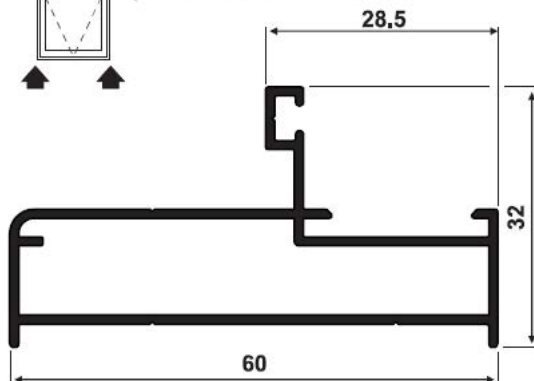

SU-379
0,570 Kg/m



TUBO P/ GRADE



SU-380
0,219 Kg/m

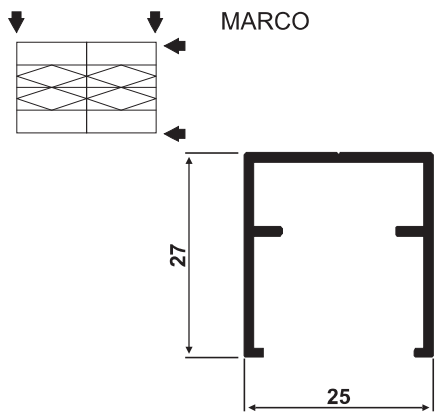
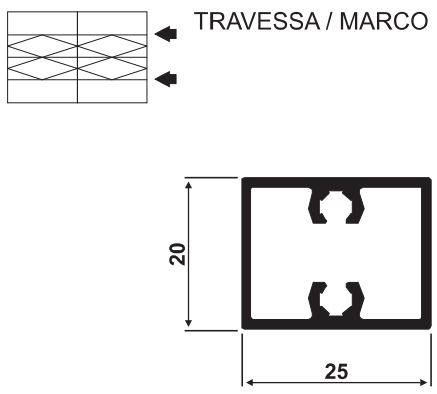
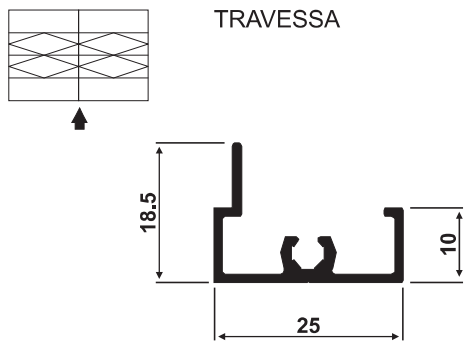
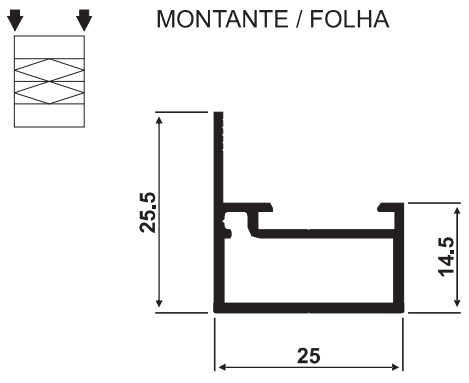
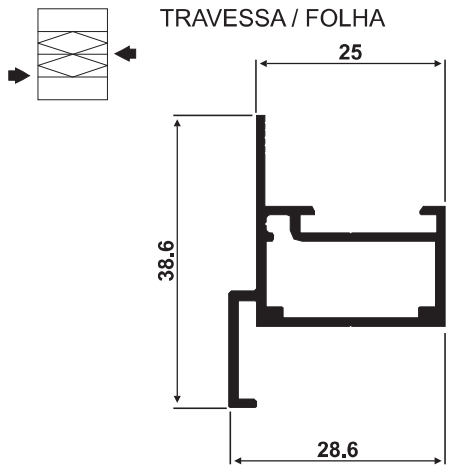
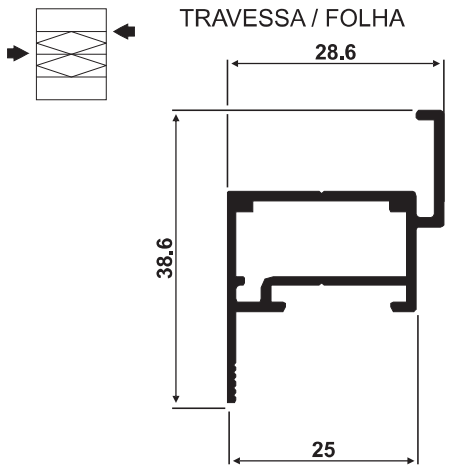

 <p>SU-093 0,282 Kg/m</p>	 <p>SU-094 0,371 Kg/m</p>
 <p>SU-095 0,225 Kg/m</p>	 <p>SU-096 0,314 Kg/m</p>
 <p>SU-097 0,401 Kg/m</p>	 <p>SU-098 0,401 Kg/m</p>

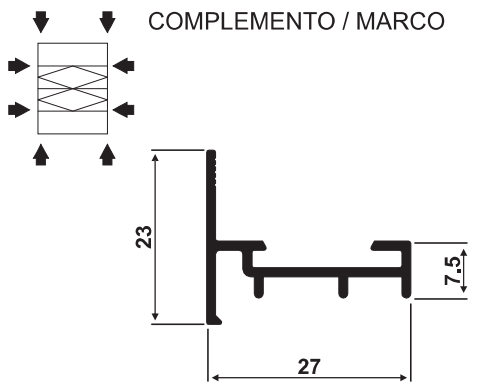
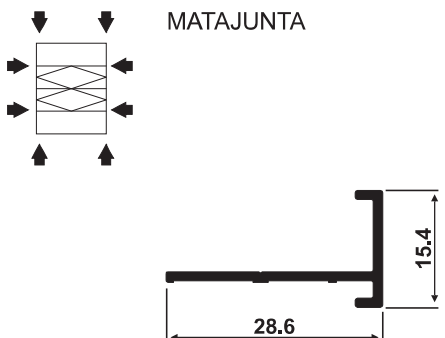
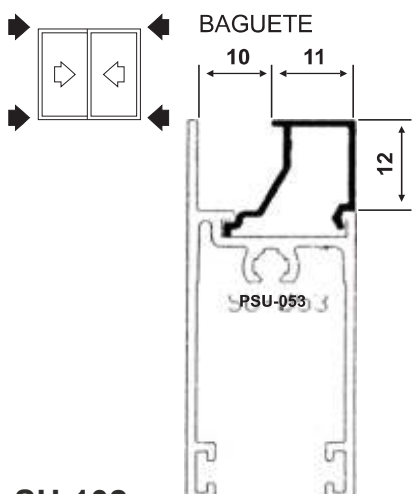
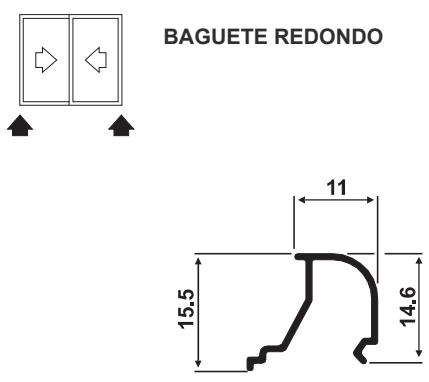
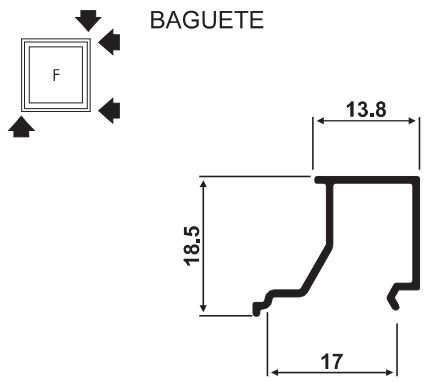
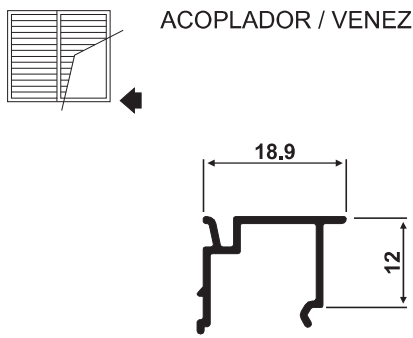

<p>COMPLEMENTO / MARCO</p>  <p>SU-099 0,230 Kg/m</p>	<p>MATAJUNTA</p>  <p>SU-100 0,157 Kg/m</p>
<p>BAGUETE</p>  <p>SU-102 0,111 Kg/m</p>	<p>BAGUETE REDONDO</p>  <p>SU-402 0,119 Kg/m</p>
<p>BAGUETE</p>  <p>SU-103 0,140 Kg/m</p>	<p>ACOPLADOR / VENEZIANA</p>  <p>SU-203 0,133 Kg/m</p>

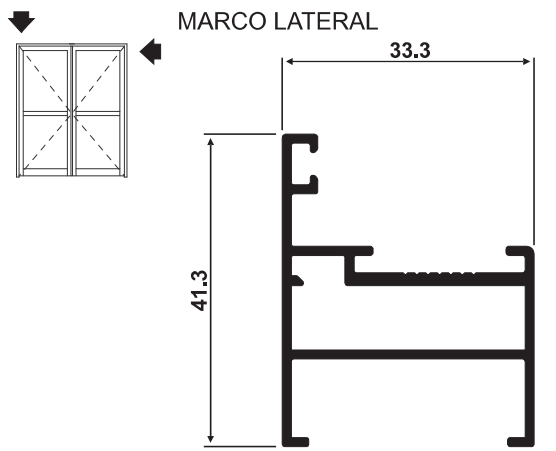
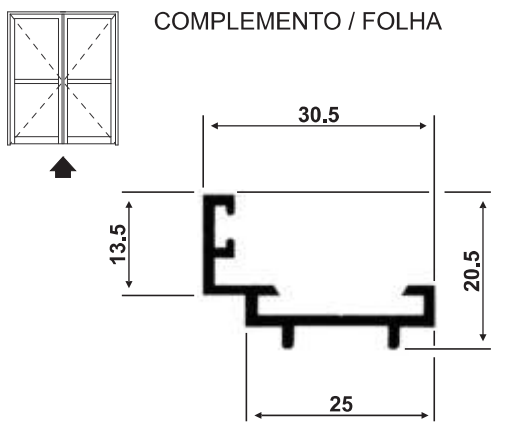
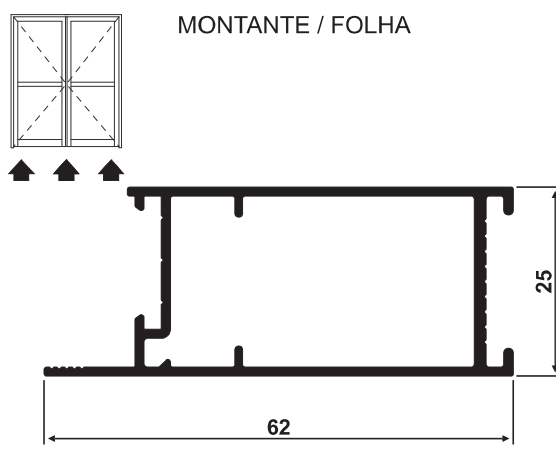
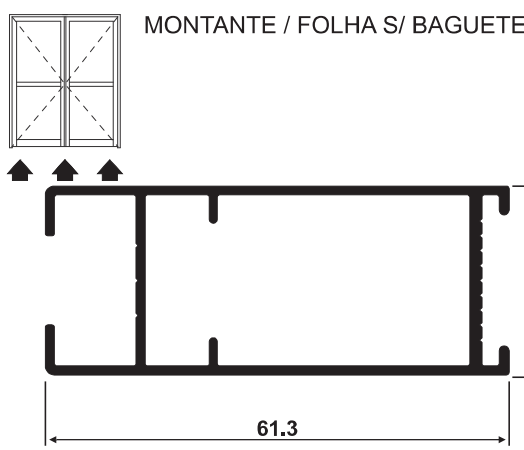
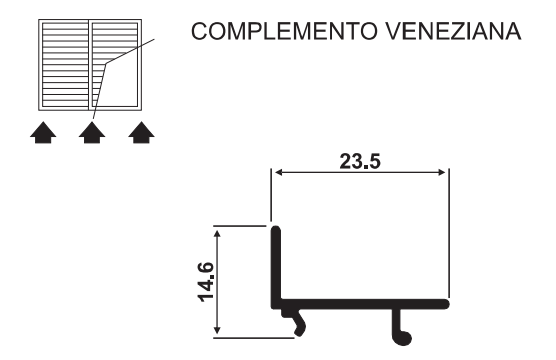
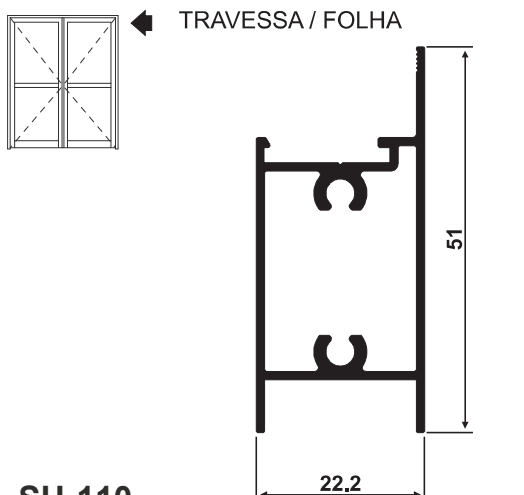

 <p>MARCO LATERAL</p> <p>33.3</p> <p>41.3</p> <p>SU-279 0,549 Kg/m</p>	 <p>COMPLEMENTO / FOLHA</p> <p>30.5</p> <p>13.5</p> <p>20.5</p> <p>25</p> <p>25-548 0,269 Kg/m</p>
 <p>MONTANTE / FOLHA</p> <p>25</p> <p>62</p> <p>SU-111 0,614 Kg/m</p>	 <p>MONTANTE / FOLHA S/ BAGUETE</p> <p>25</p> <p>61.3</p> <p>SU-241 0,668 Kg/m</p>
 <p>COMPLEMENTO VENEZIANA</p> <p>23.5</p> <p>14.6</p> <p>SU-108 0,138 Kg/m</p>	 <p>TRAVESSA / FOLHA</p> <p>51</p> <p>22.2</p> <p>SU-110 0,521 Kg/m</p>



COMPLEMENTO MARCO

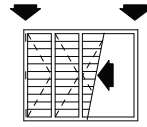
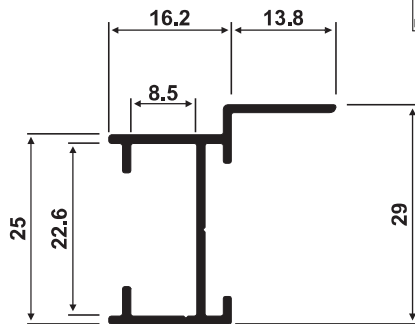

SU-071
0,255 Kg/m

MONTANTE/FOLHA VENEZIANA

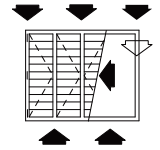
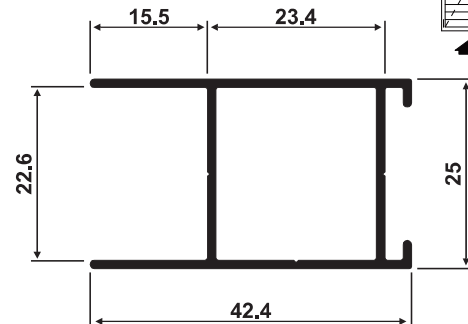

SU-072
0,402 Kg/m

TRAVESSA / FOLHA VENEZIANA

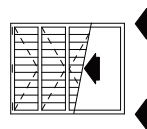
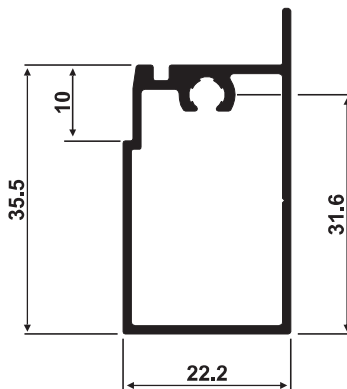

SU-073
0,419 Kg/m

MONTANTE / FOLHA VENEZIANA

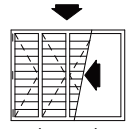
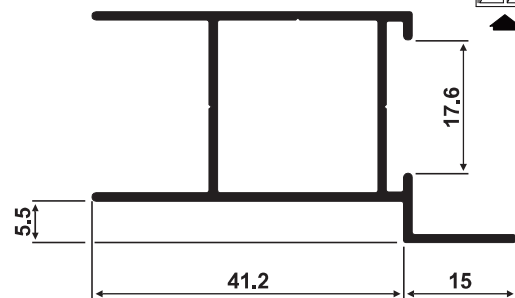

SU-074
0,460 Kg/m

SUPOORTE

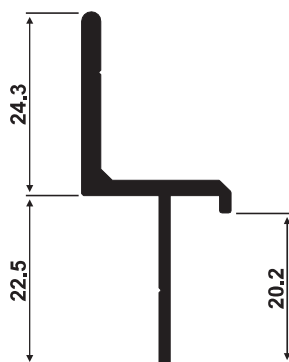

SU-101
0,360 Kg/m

VEDAÇÃO MONTANTE

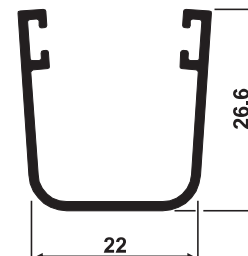
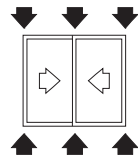

SU-107
0,266 Kg/m



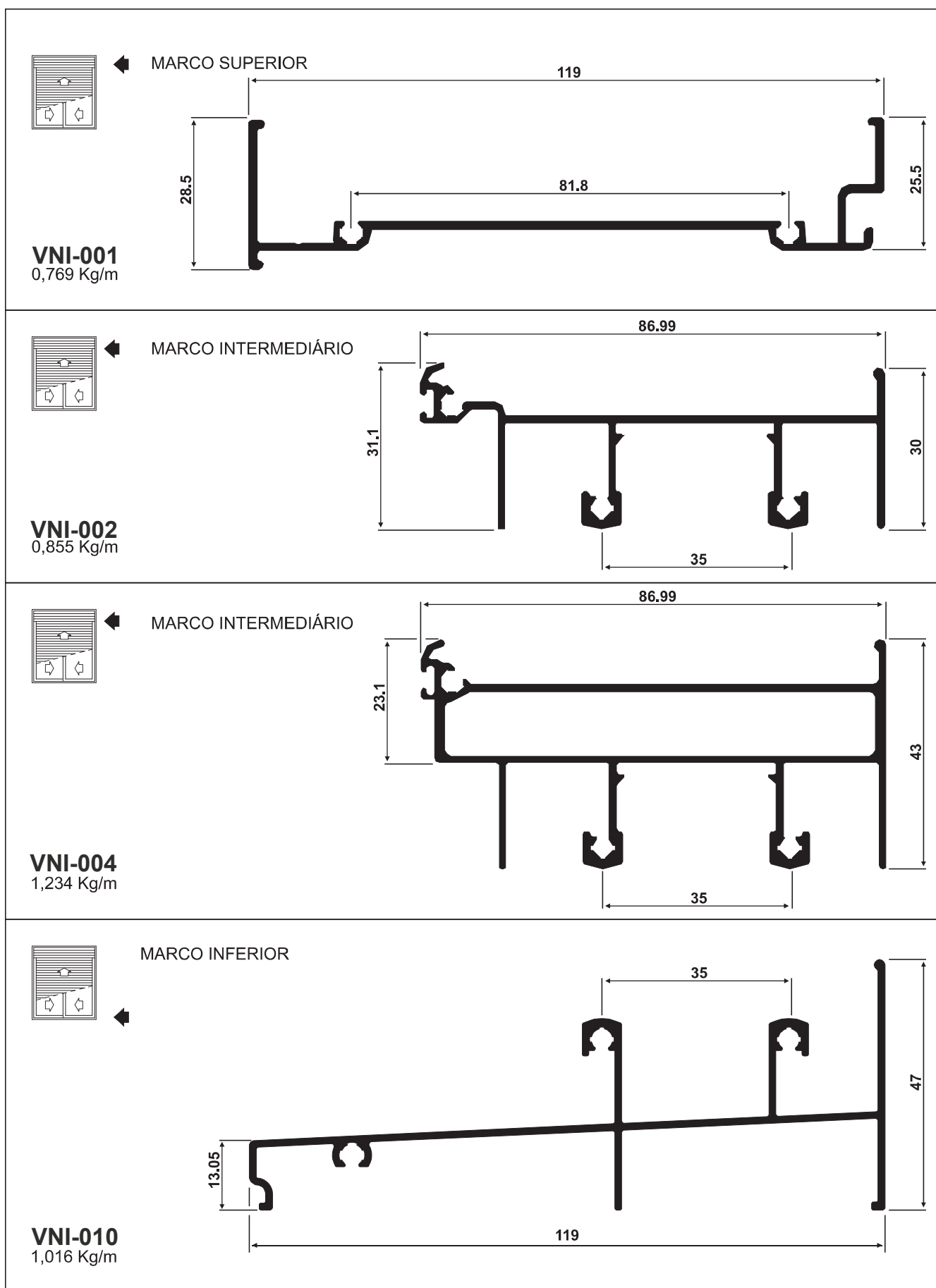

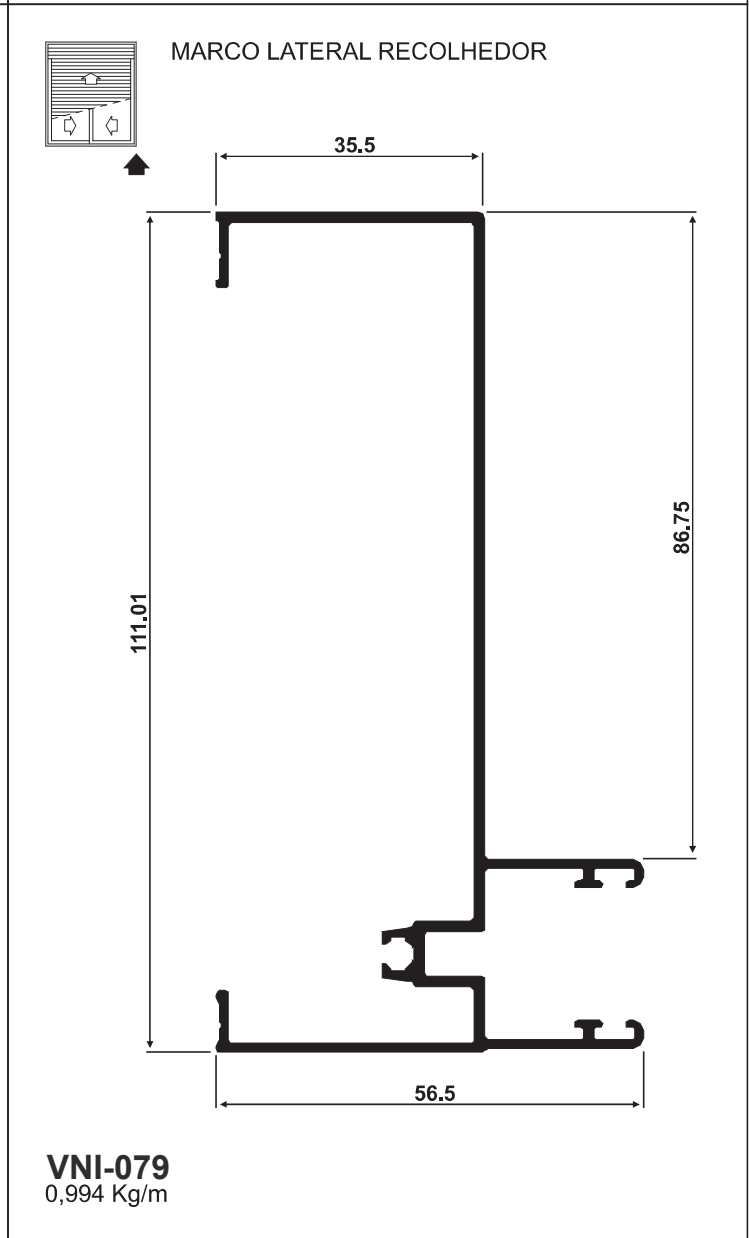
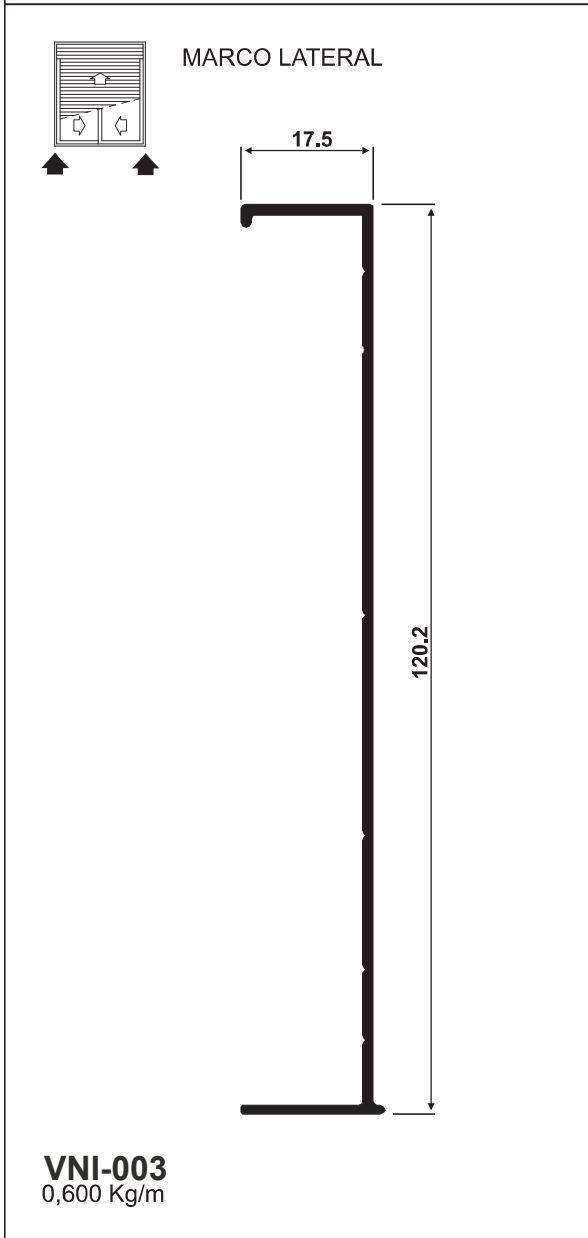
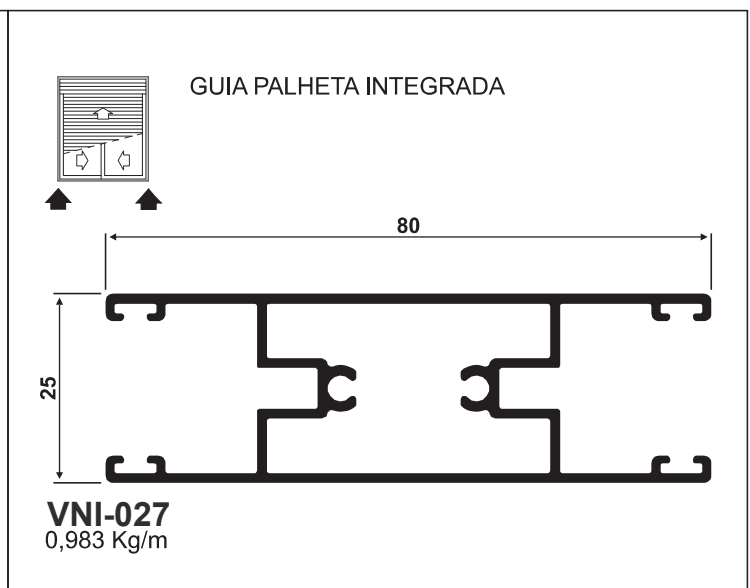
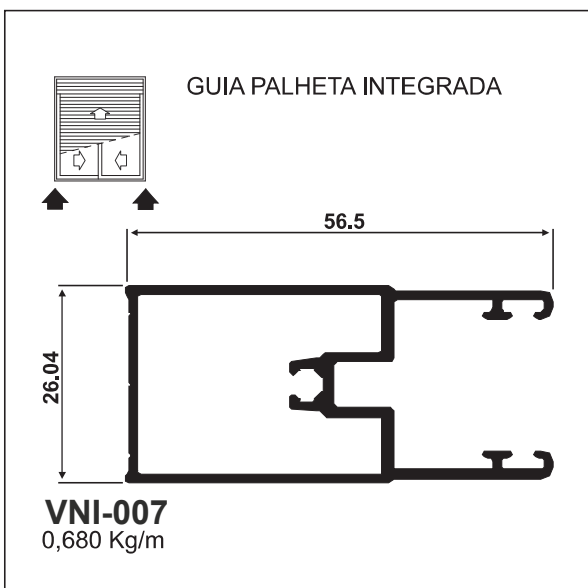

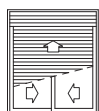

◀ TAMPA EXTERNA / JANELA

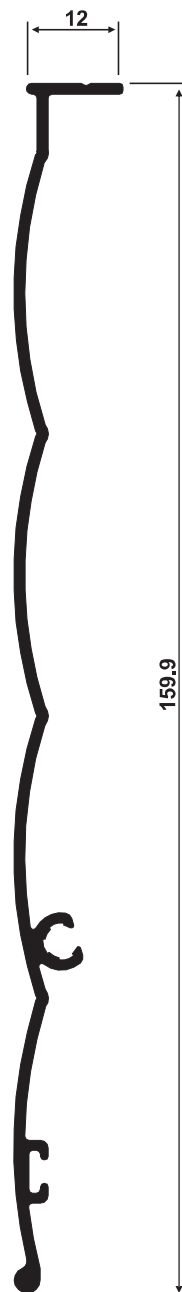

VNI-009
0,730 Kg/m

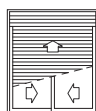

◀ TAMPA INTERNA / JANELA

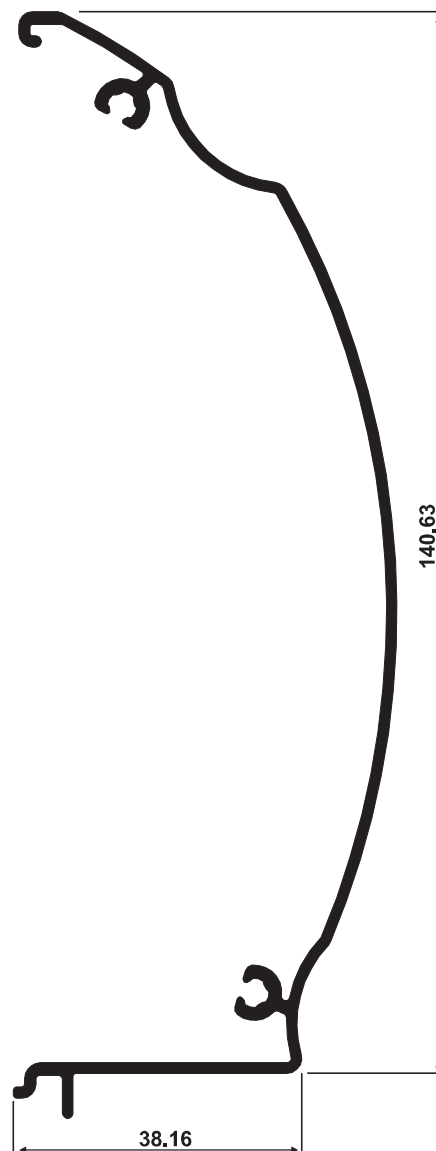

VNI-008
0,945 Kg/m



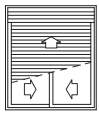

◀ TAMPA EXTERNA / PORTA

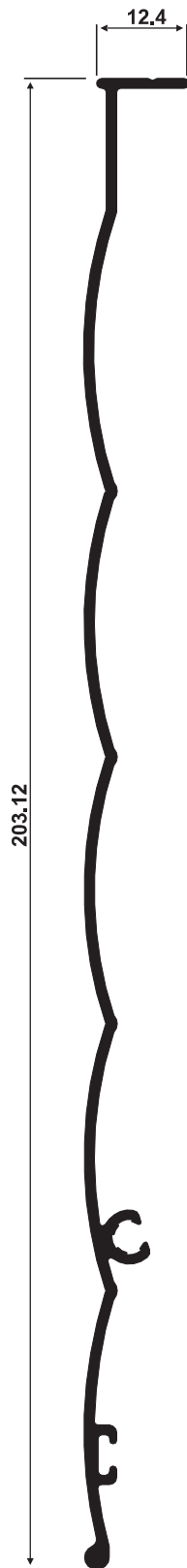

VNI-039
0,965 Kg/m

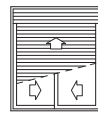

◀ TAMPA INTERNA / PORTA

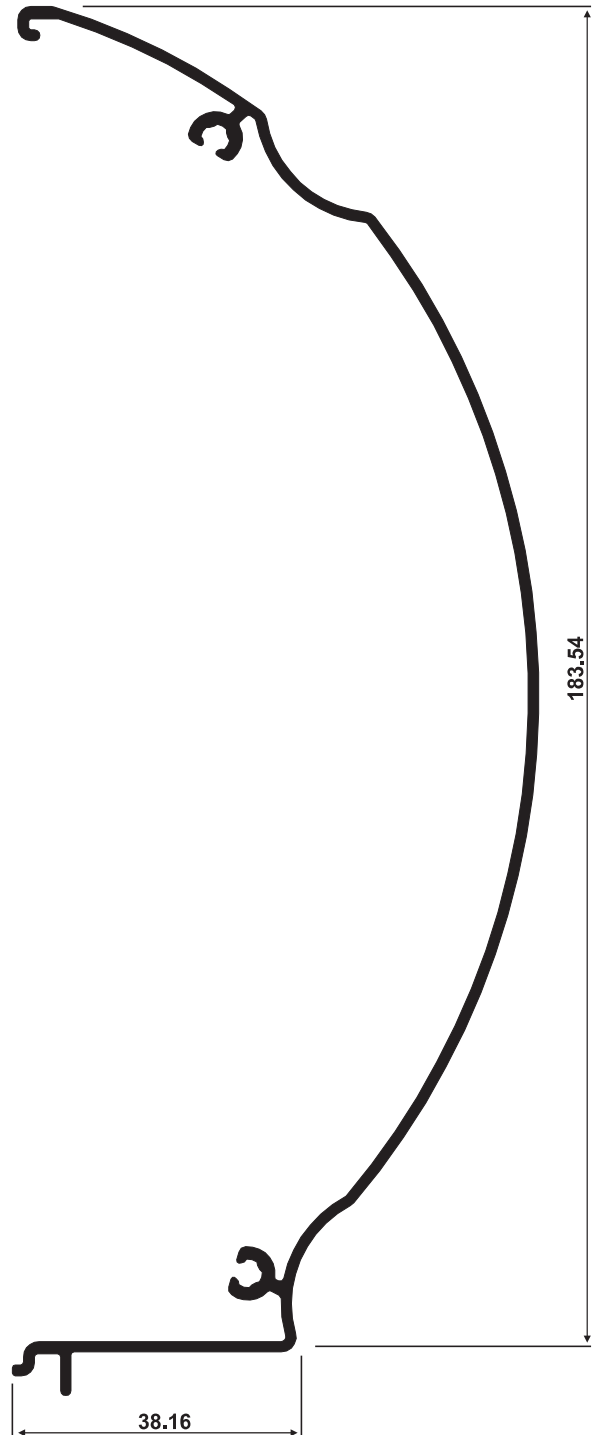

VNI-040
1,238 Kg/m



MARCO SUPERIOR

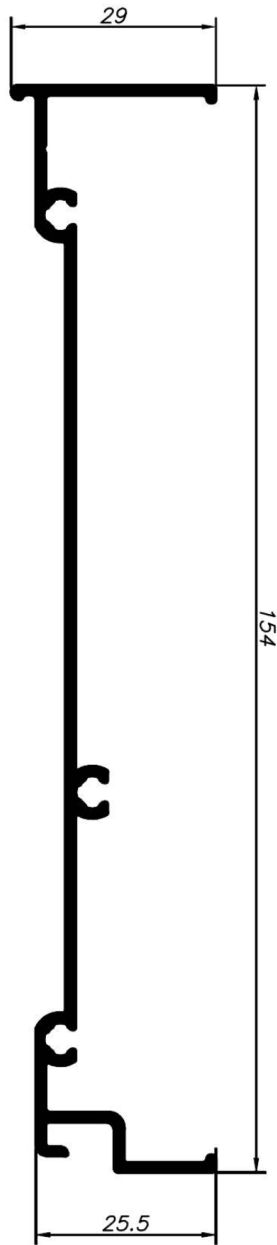

VNI-251

0,958 kg/mt

MARCO LATERAL

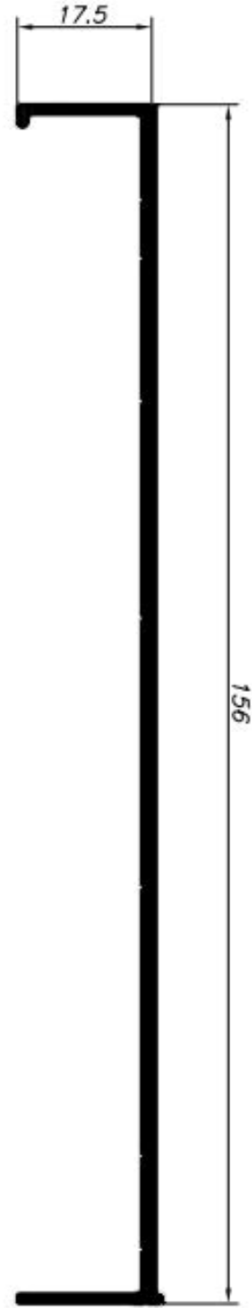

VNI-253

0,742 kg/mt



MARCO INTERMEDIÁRIO

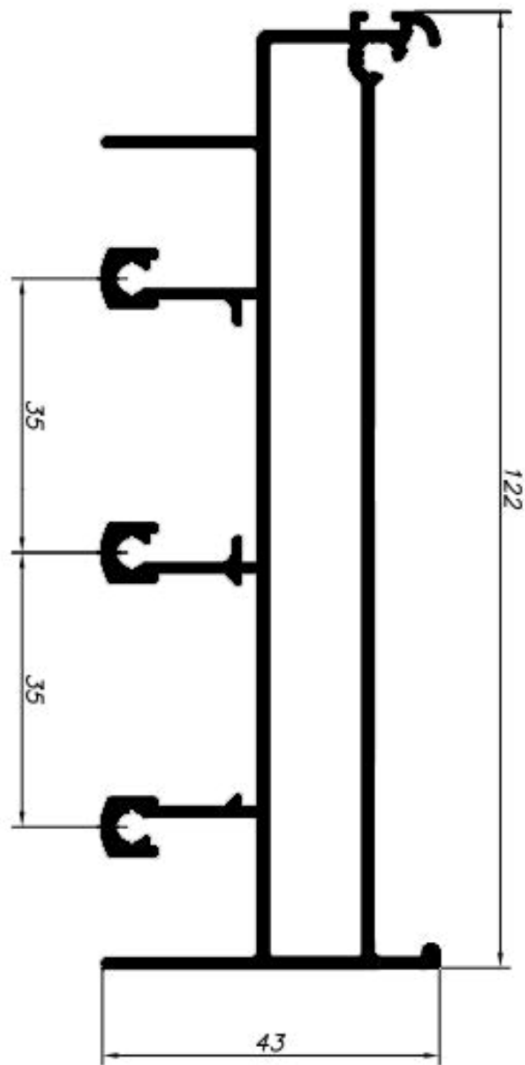

VNI-254

1,627 kg/mt

MARCO LATERAL RECOLHEDOR

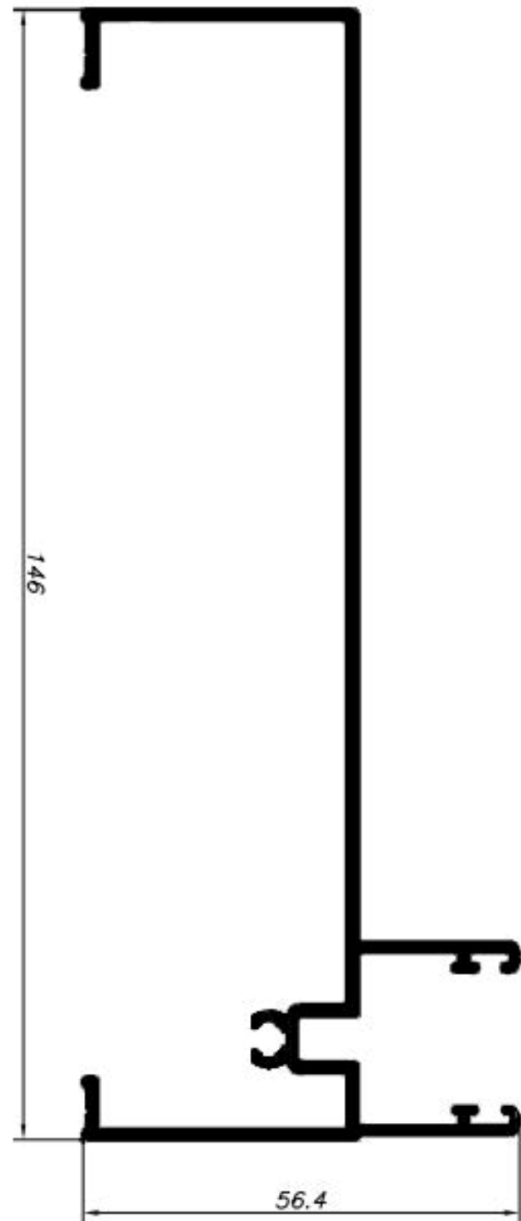

VNI-259

1,162 kg/mt



MARCO INFERIOR

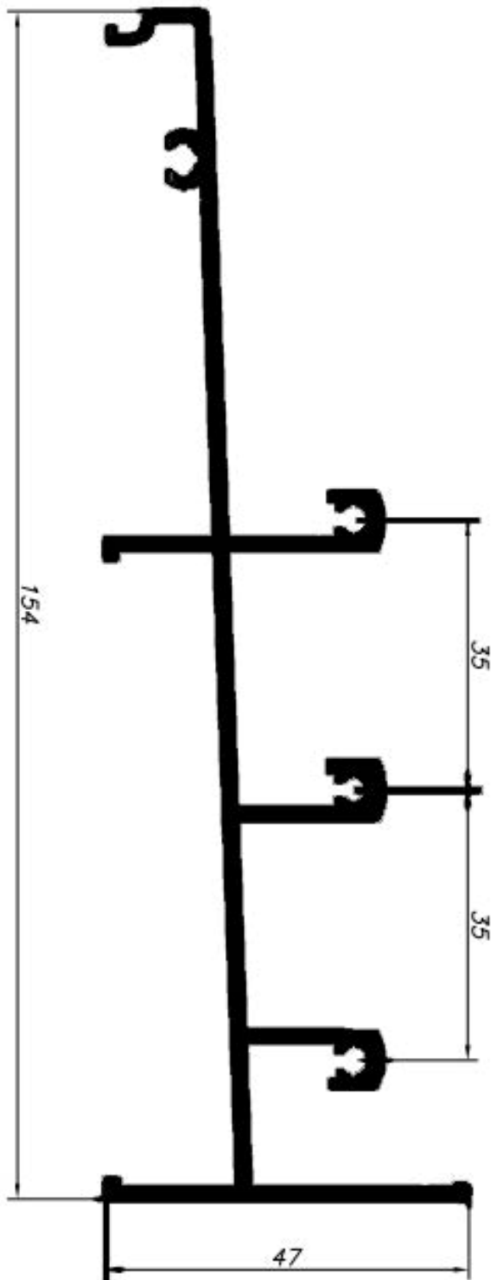

VNI-260

1,280 kg/mt



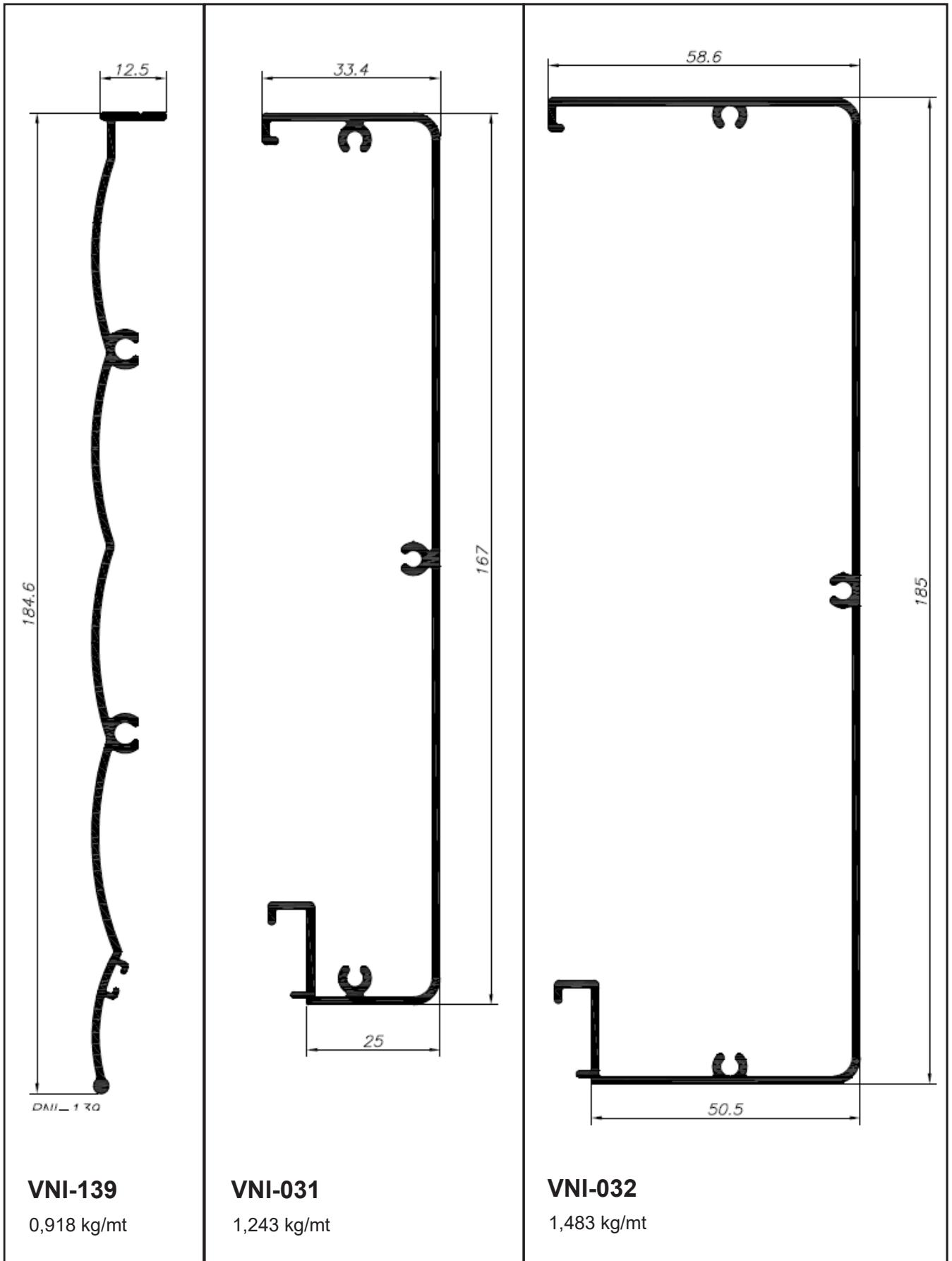

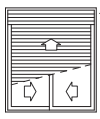

EIXO

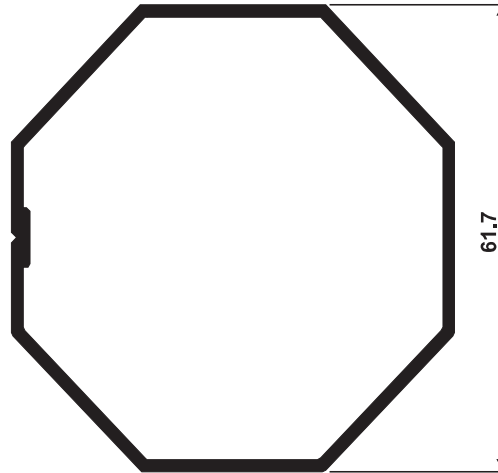

VNI-015
0,833 Kg/m

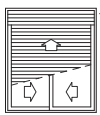

EIXO

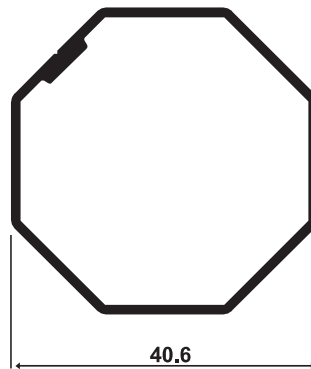

VNI-014
0,459 Kg/m

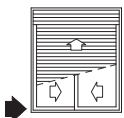

GUIA



VNI-055
0,359 Kg/m



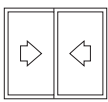

TRILHO SUPERIOR
JANELA/PORTA

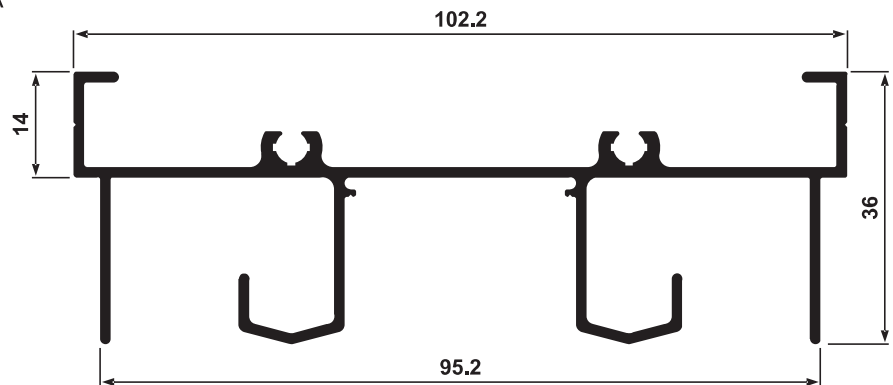

LG-044
1,207 kg/m

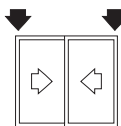

MARCO LATERAL
PORTA / JANELA

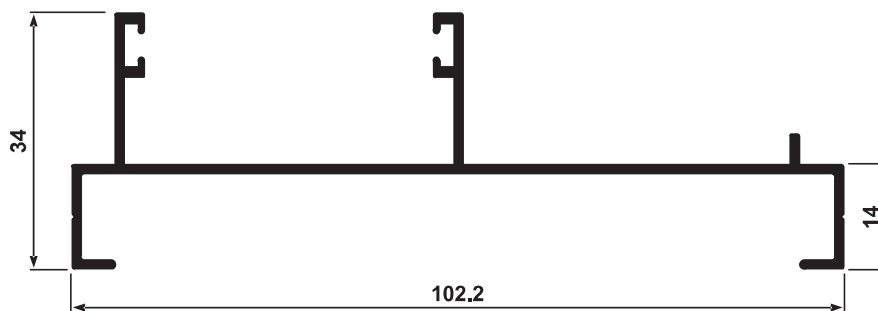

LG-124
0,773 kg/m

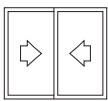

TRILHO INFERIOR
JANELA

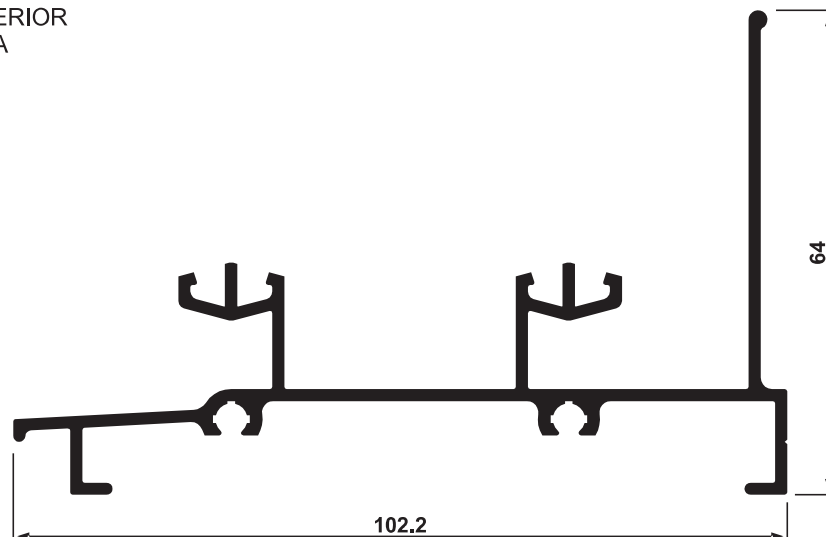

LG-115
1,296 kg/m



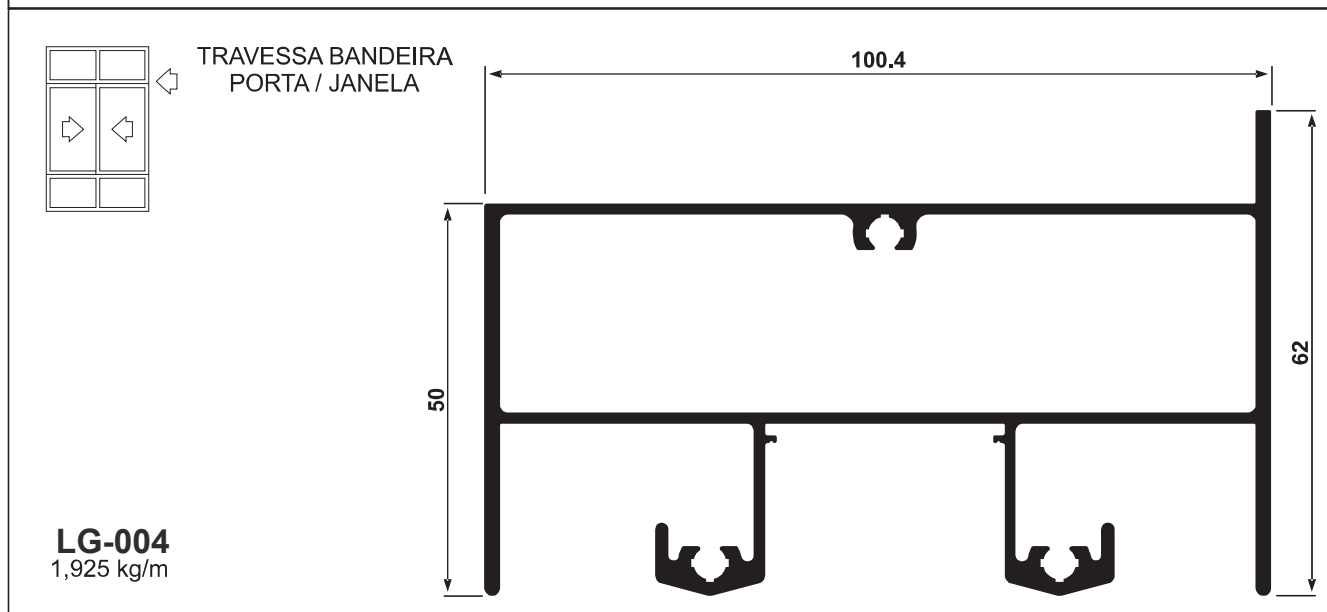
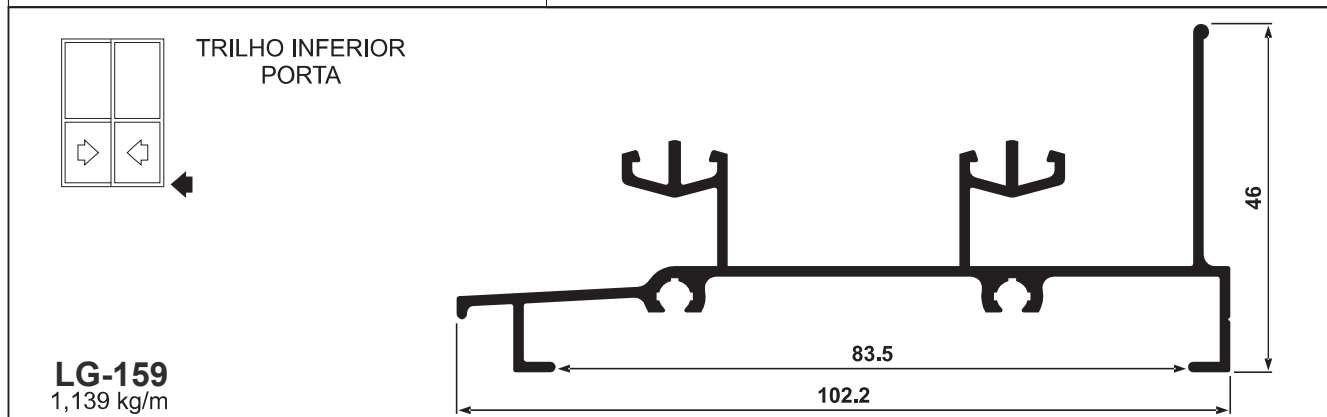
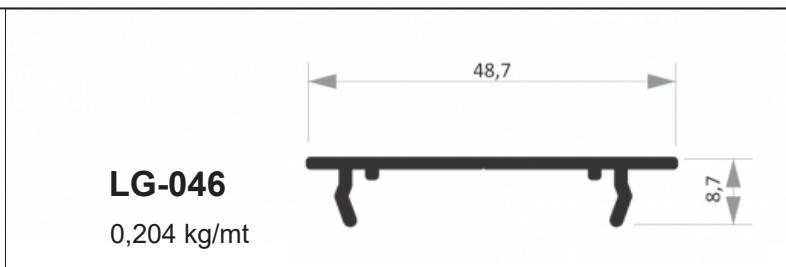
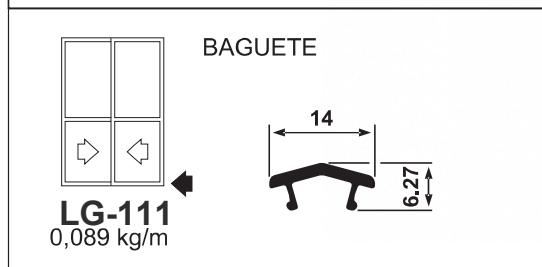
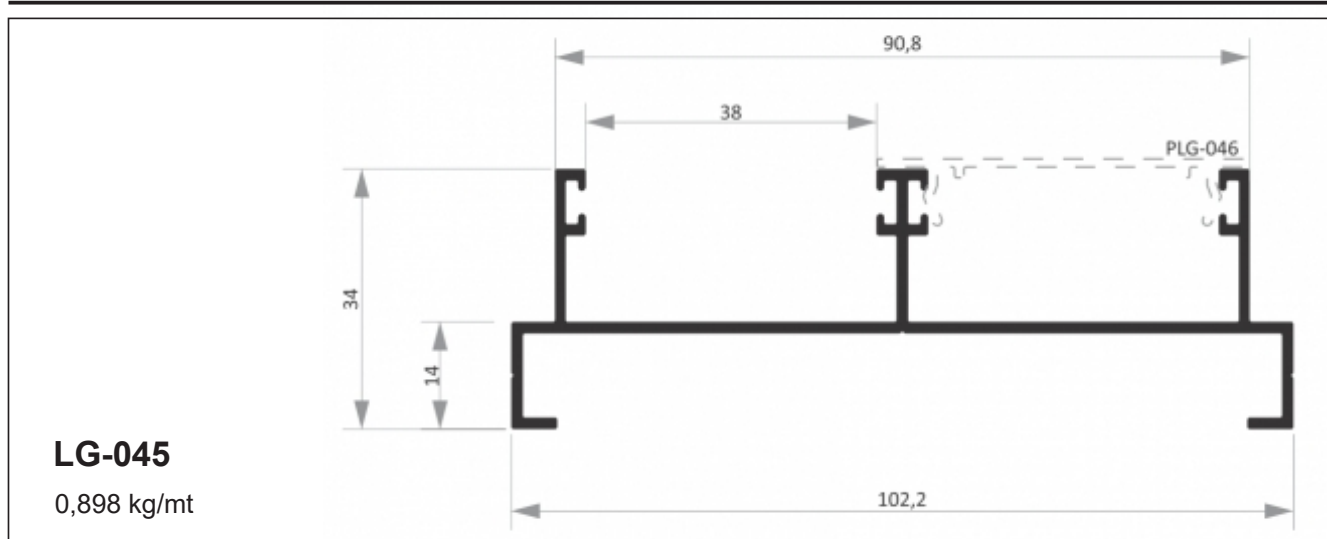

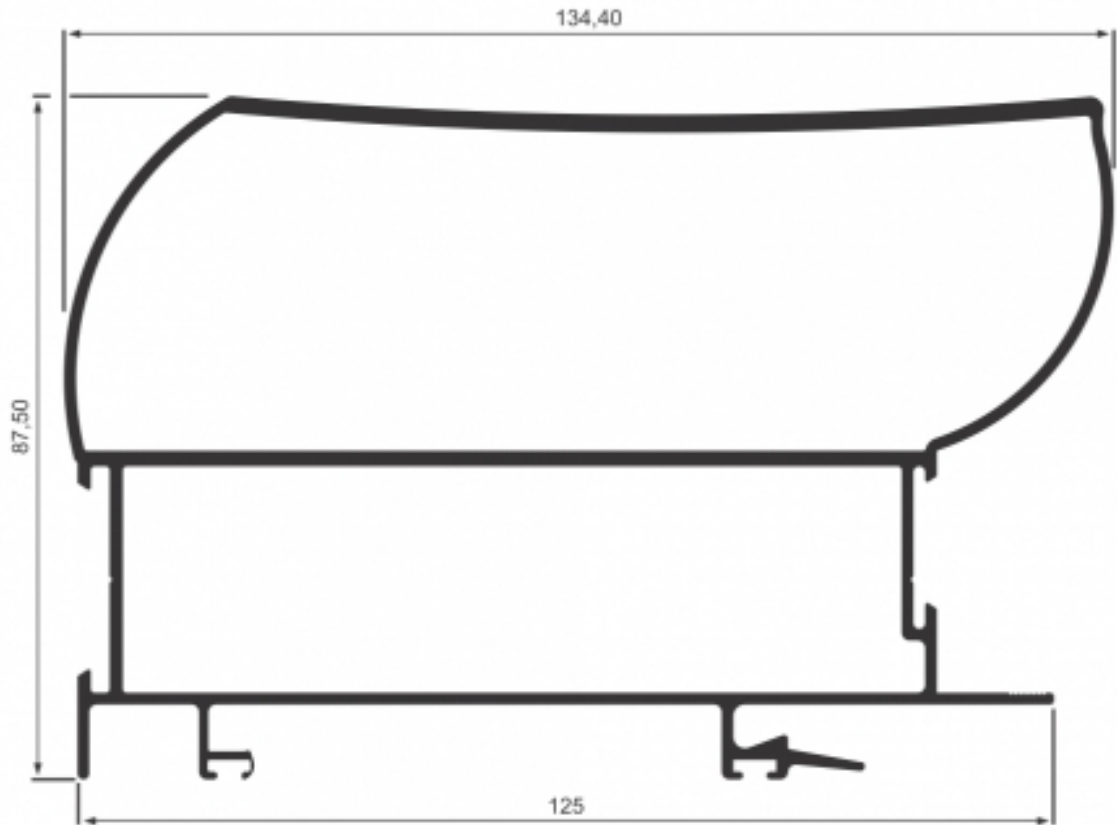

LG-210

2,909 kg/mt

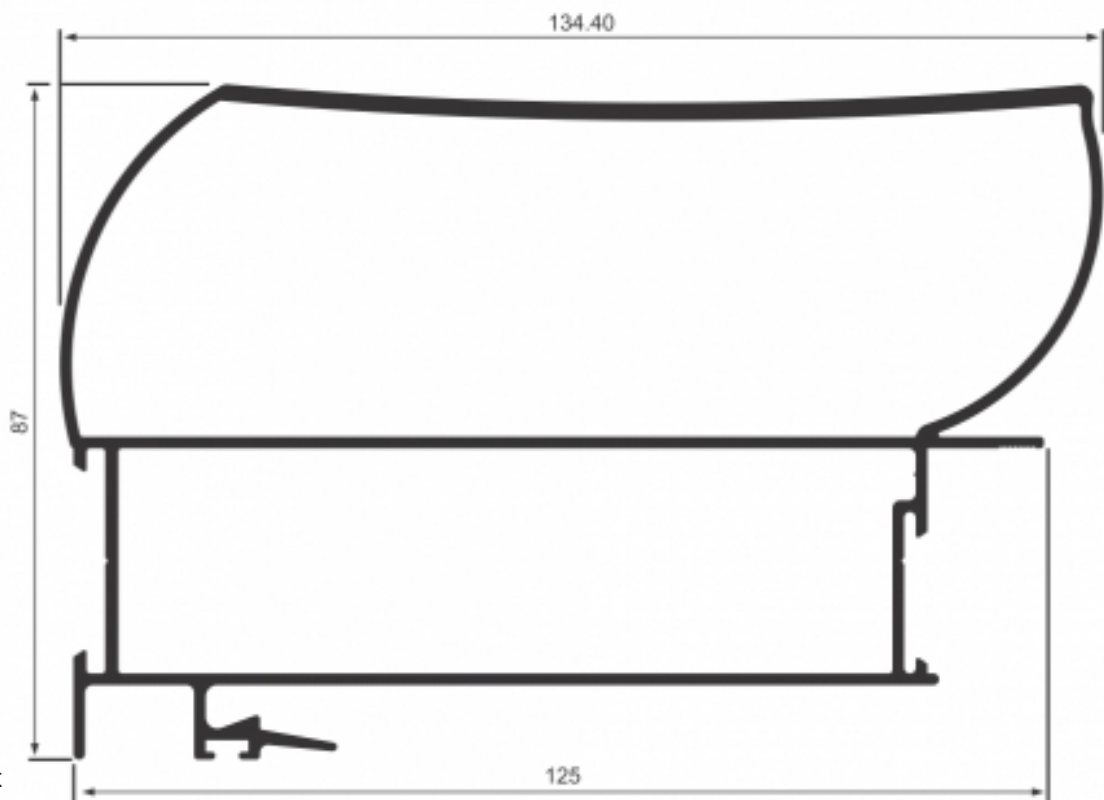

LG-520

2,697 kg/mt



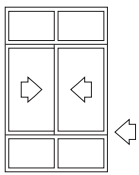

TRAVESSA PEITORIL
JANELA

LG-117
1,998 kg/m

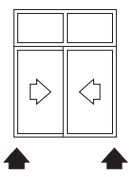
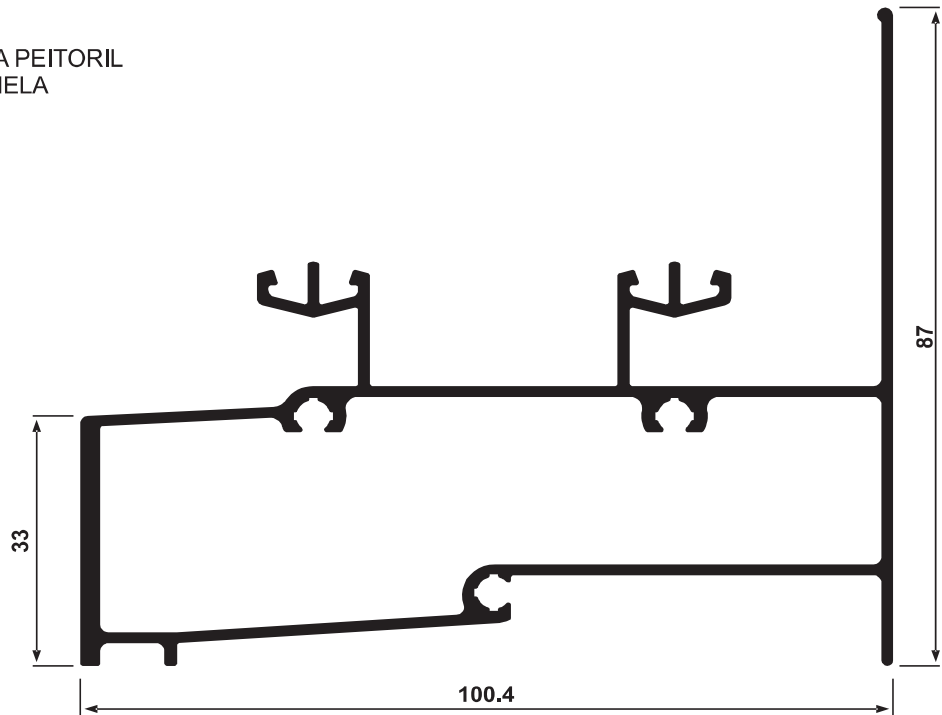

COMPLEMENTO
MARCO LATERAL

LG-028
0,441 kg/m

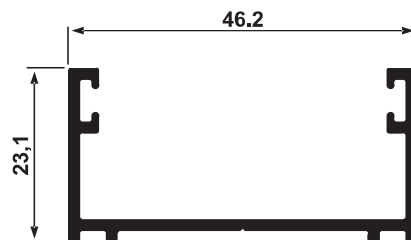

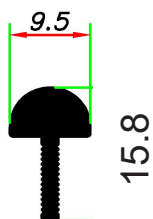

LG-030

0,171 kg/mt

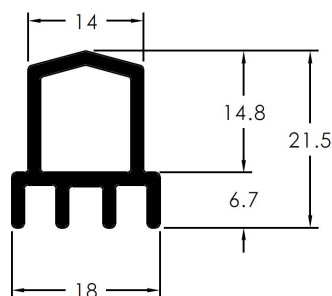

LG-061

0,317 kg/mt

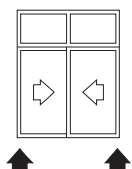

MARCO LATERAL
PORTA / JANELA



LG-002

0,584 kg/m

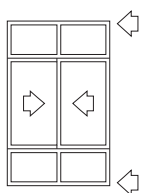

MARCO BANDEIRA PEITORIL

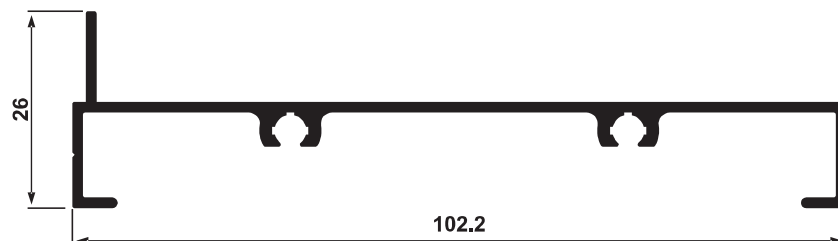

LG-003

0,706 kg/m



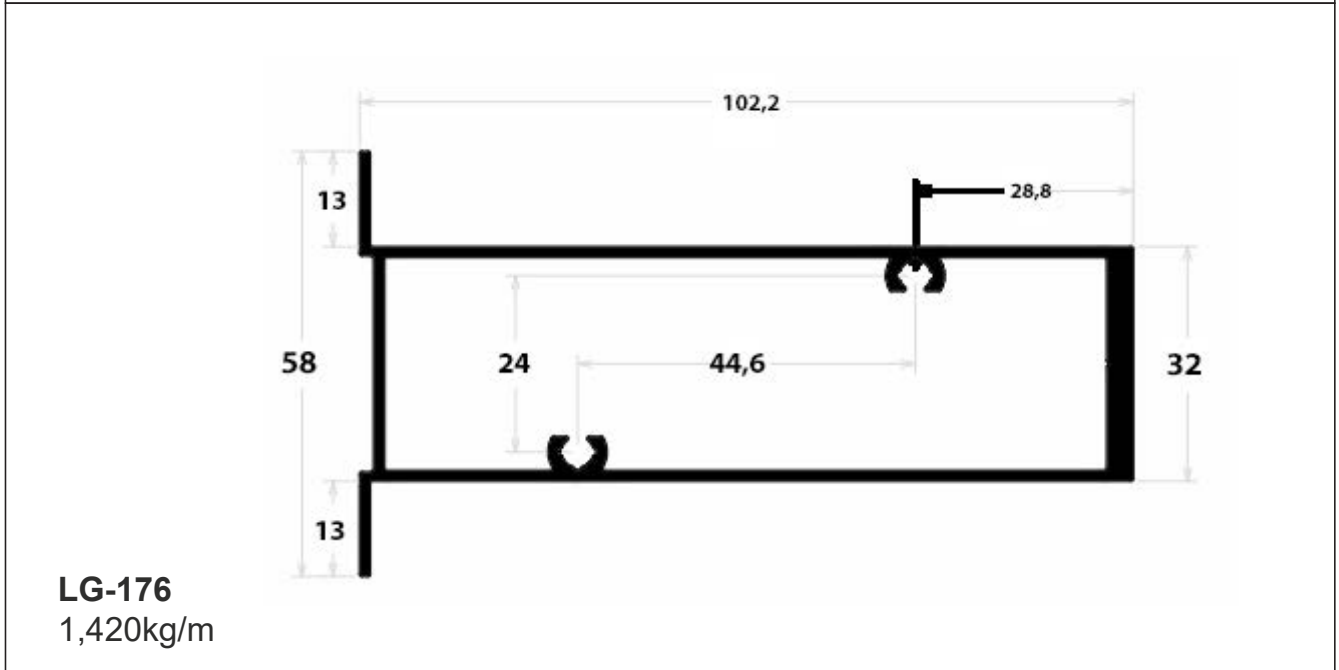
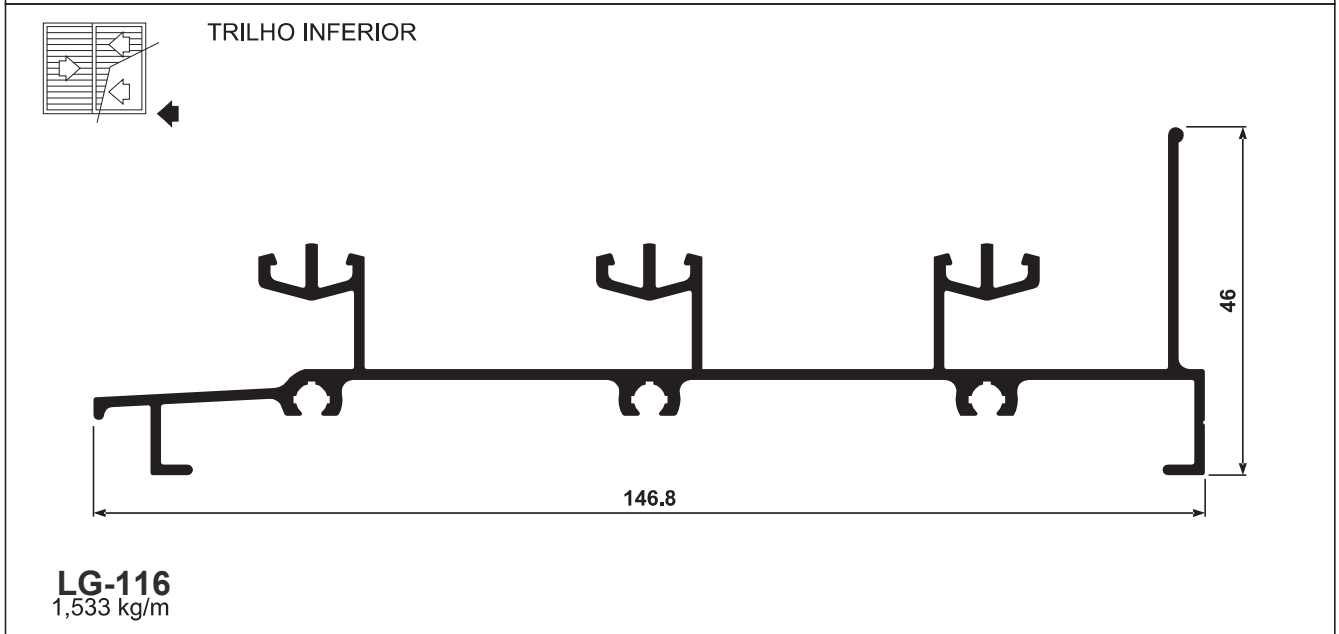
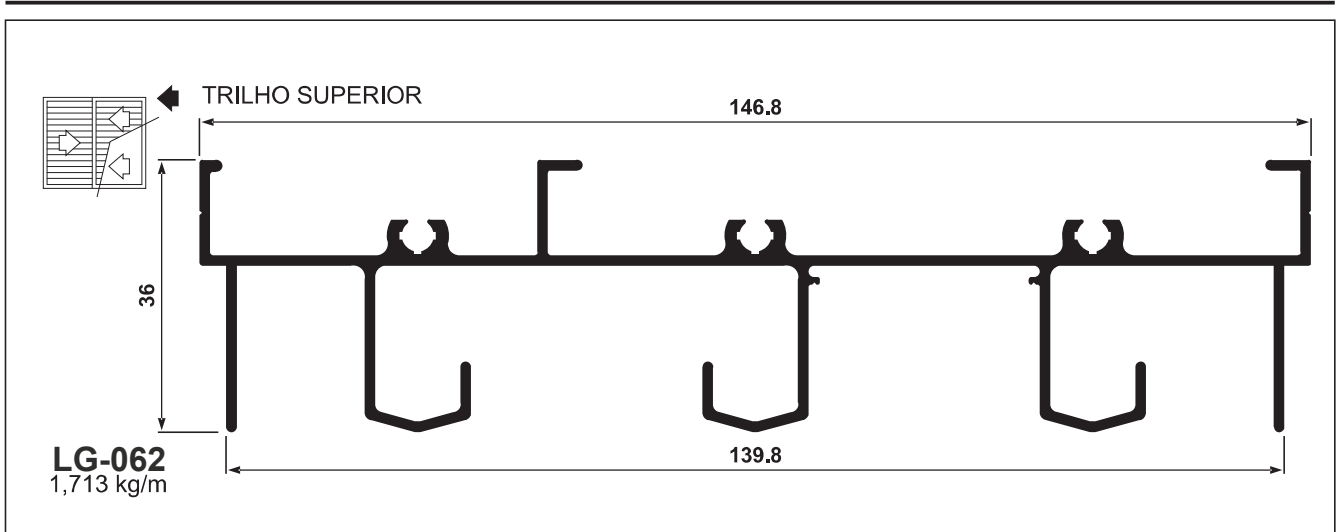

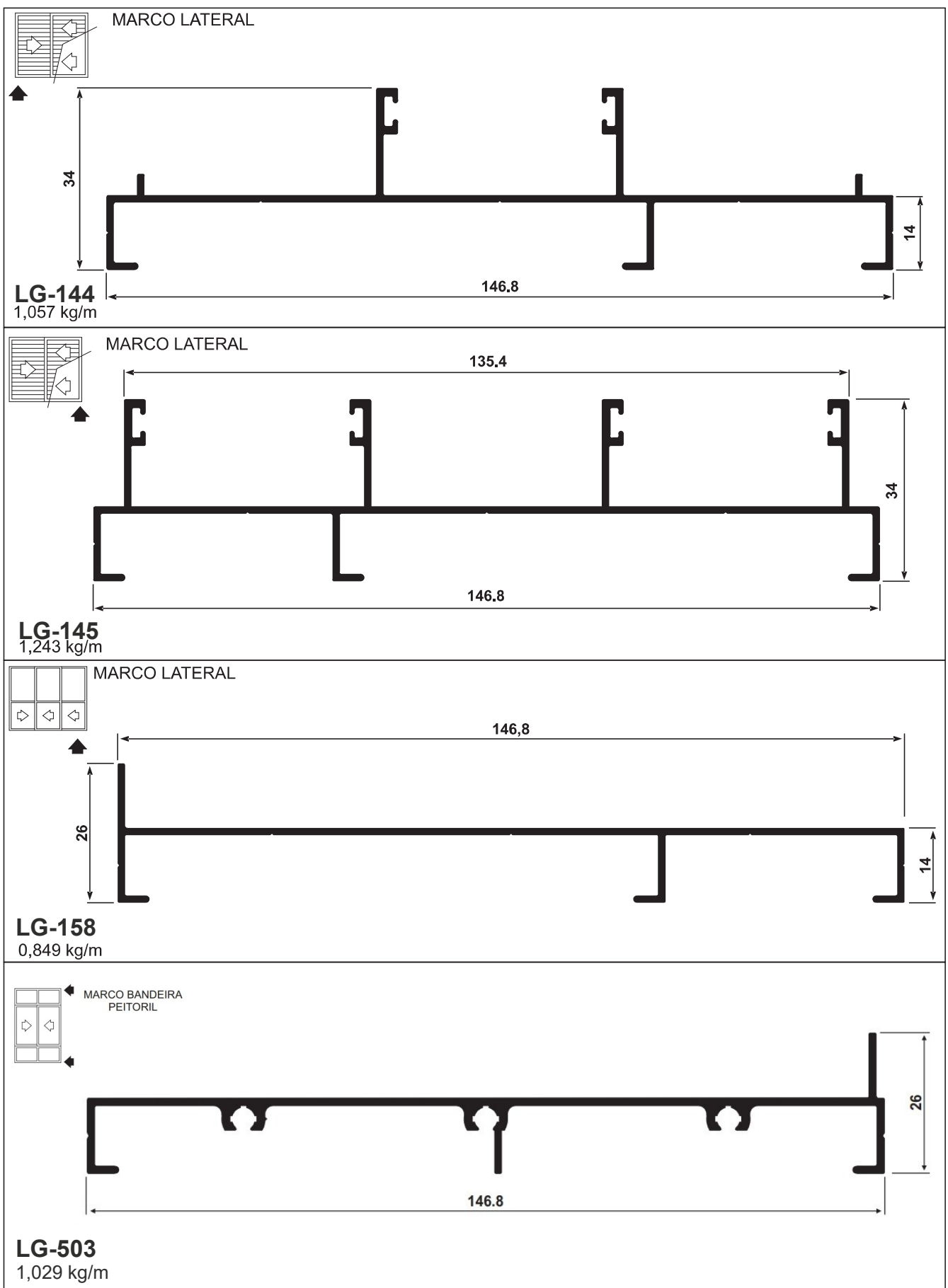

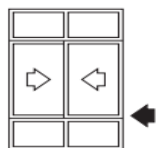

TRAVESSA PEITORIL
JANELA

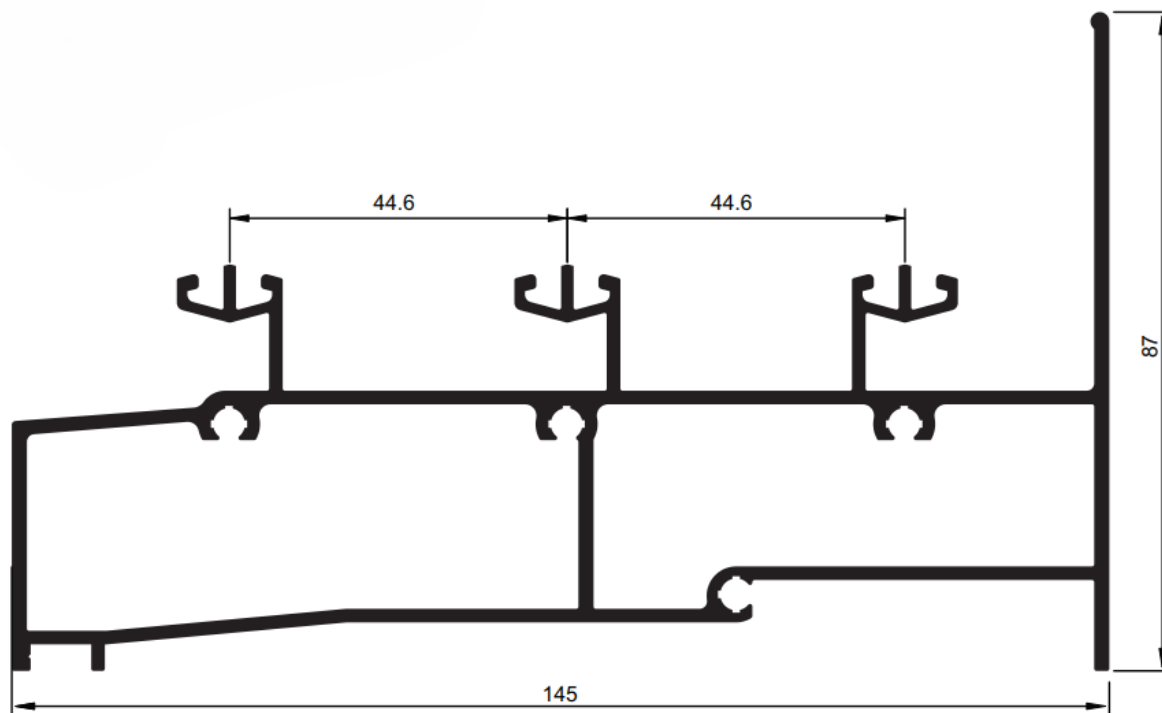

LG-517
3,033 kg/m



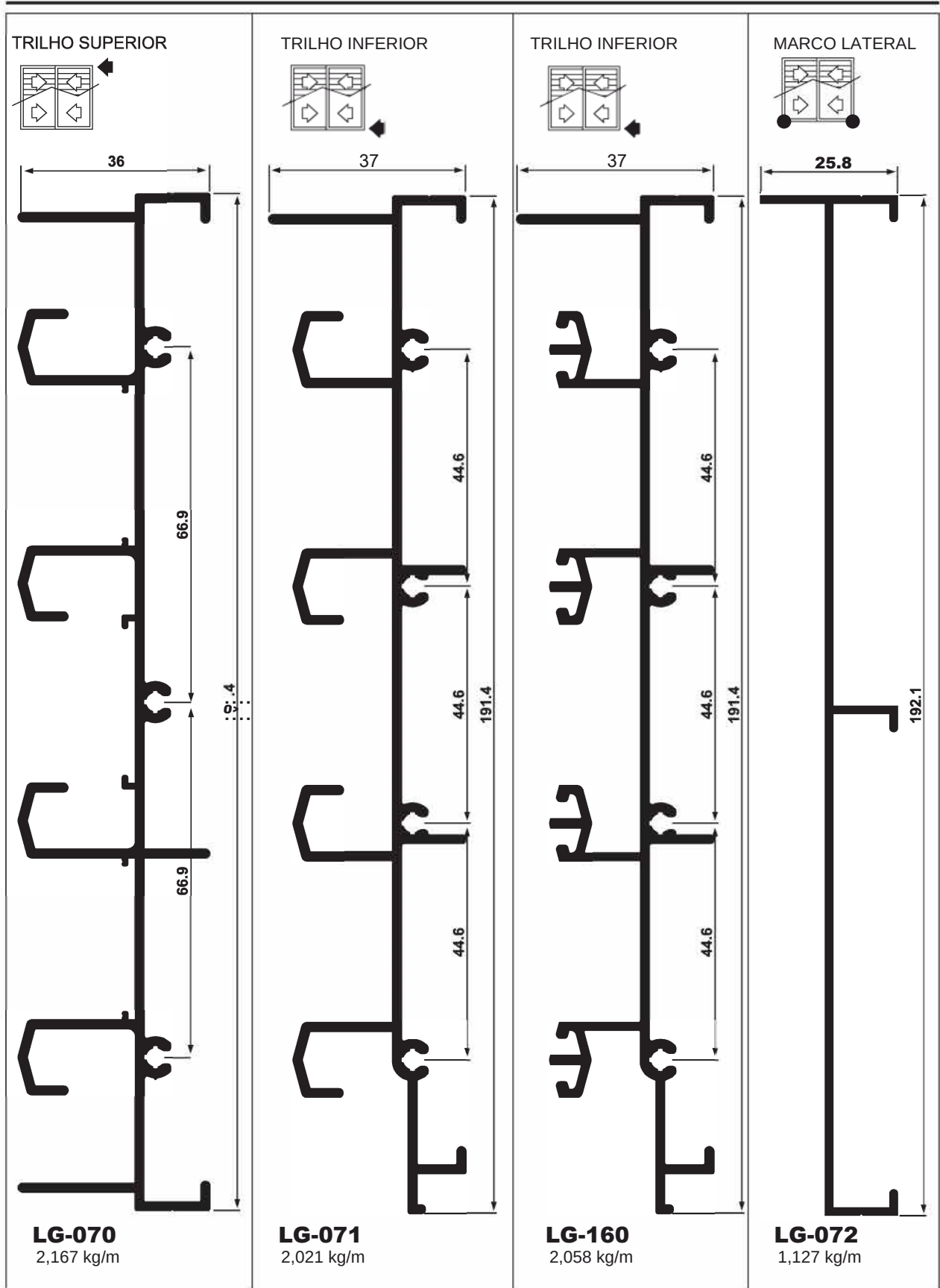

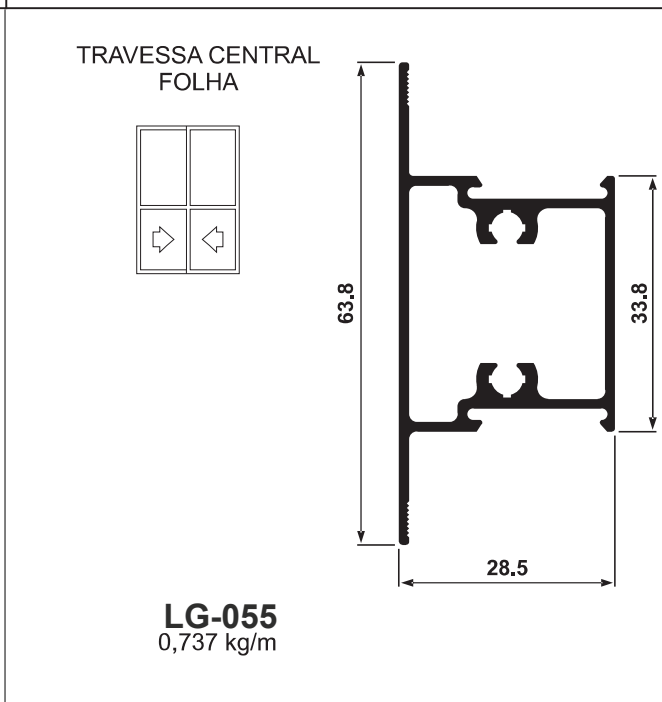
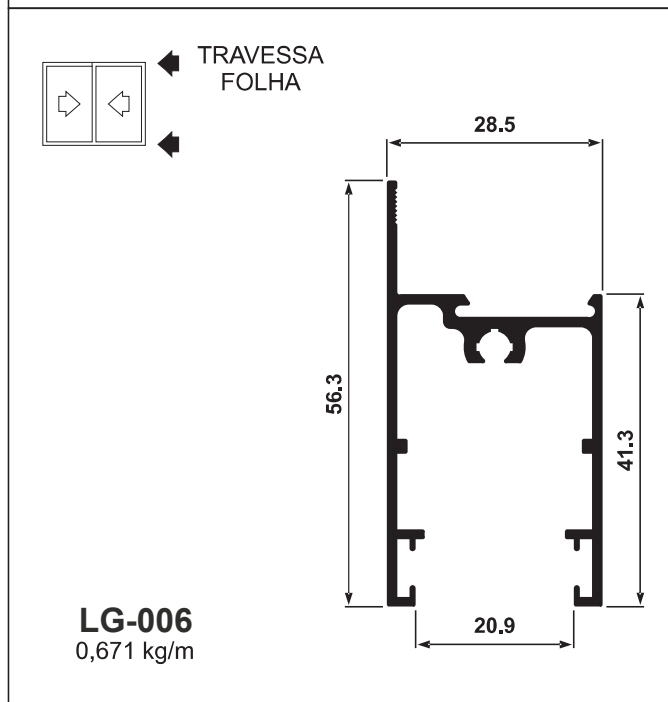
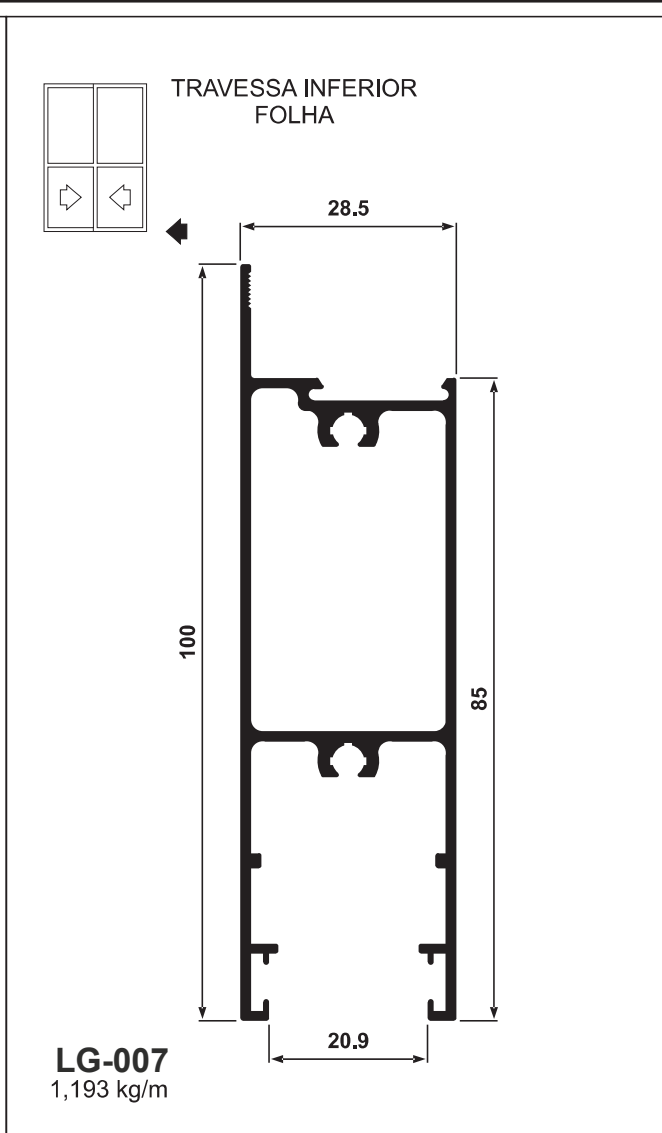
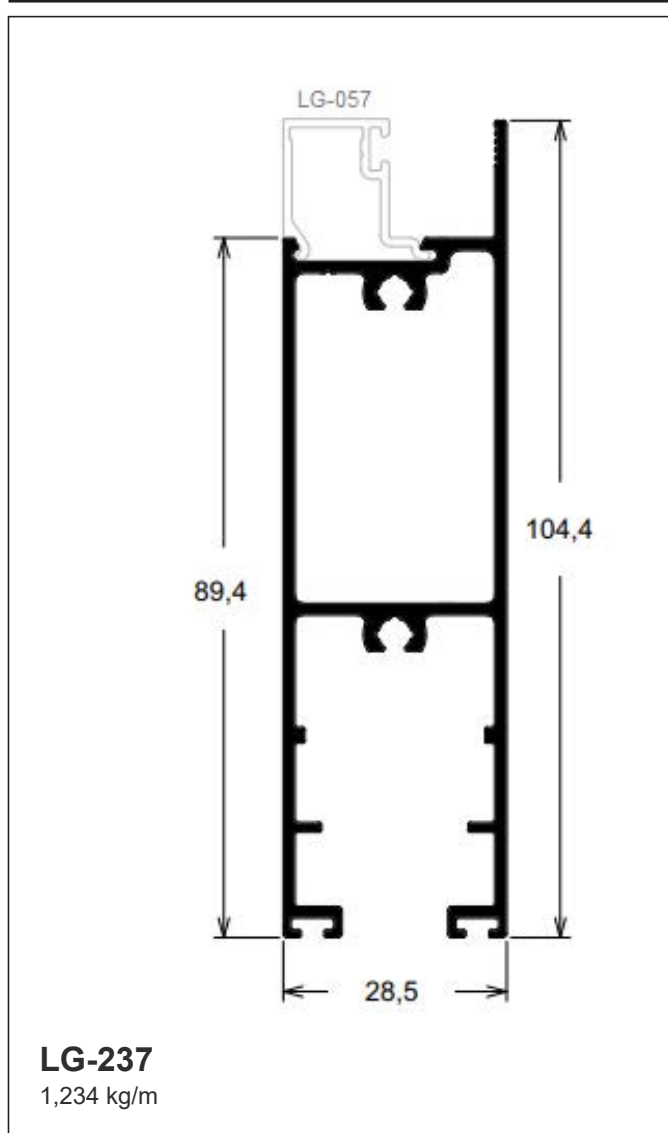

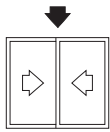

MONTANTE
MÃO DE AMIGO

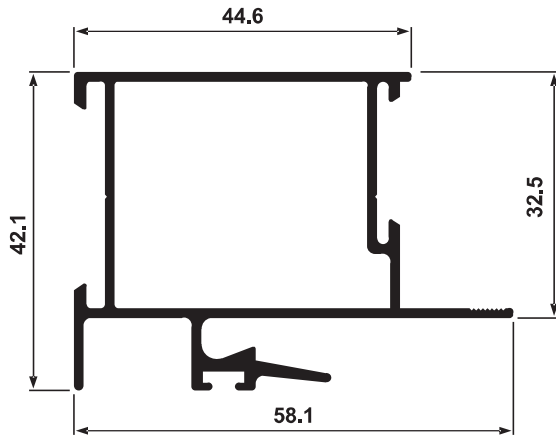

LG-048
0,918 kg/m

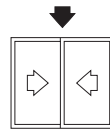

MONTANTE
MÃO DE AMIGO

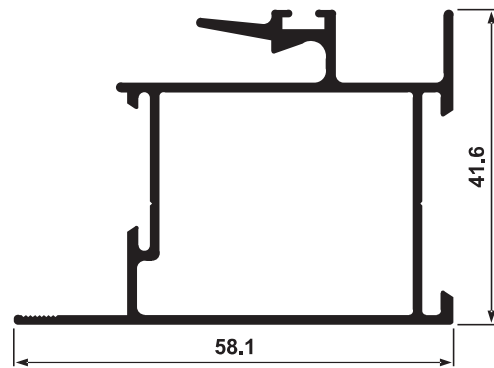

LG-049
0,877 kg/m

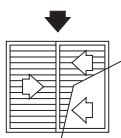

MONTANTE
MÃO DE AMIGO

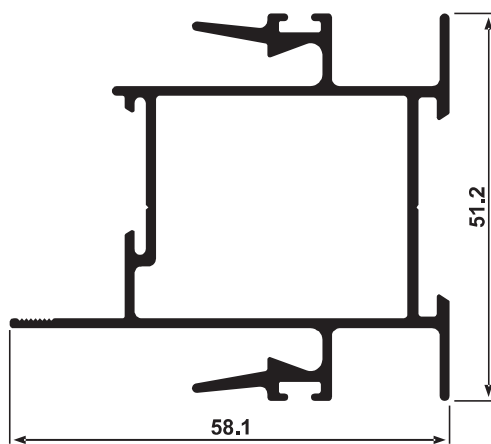

LG-162
1,059 kg/m

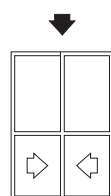

MONTANTE
MÃO DE AMIGO

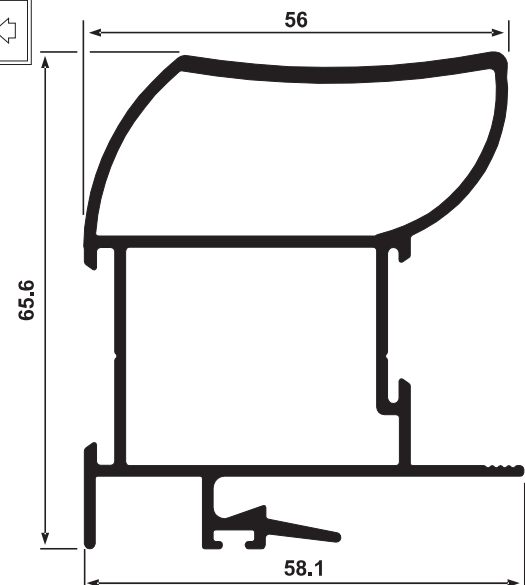

LG-018
1,282 kg/m

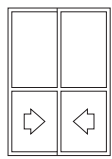
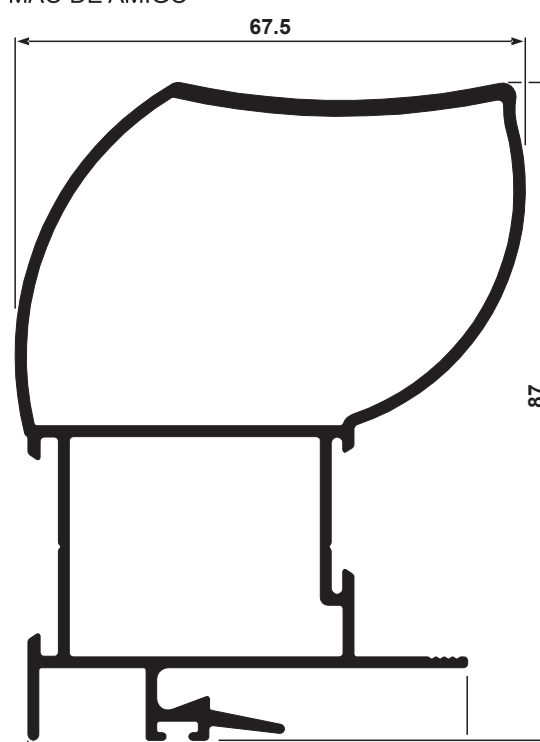
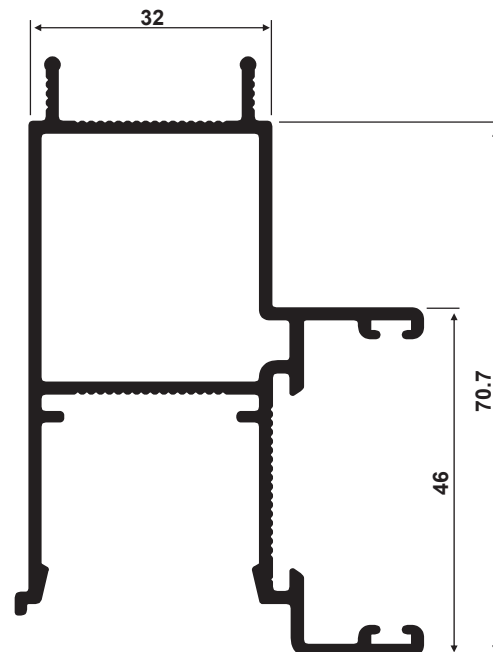
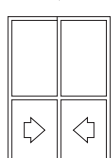
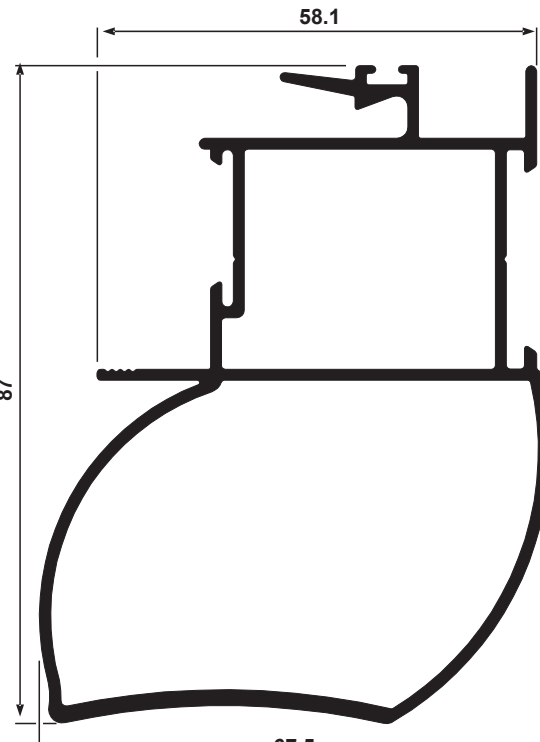
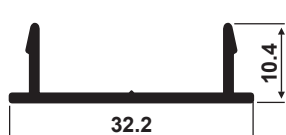

<p>  MONTANTE MÃO DE AMIGO </p>  <p> LG-137 1,526 kg/m </p>	 <p> LG-235 1,178 kg/m </p>
<p>  MONTANTE MÃO DE AMIGO </p>  <p> LG-140 1,532 kg/m </p>	 <p> LG-236 0,172 kg/m </p>



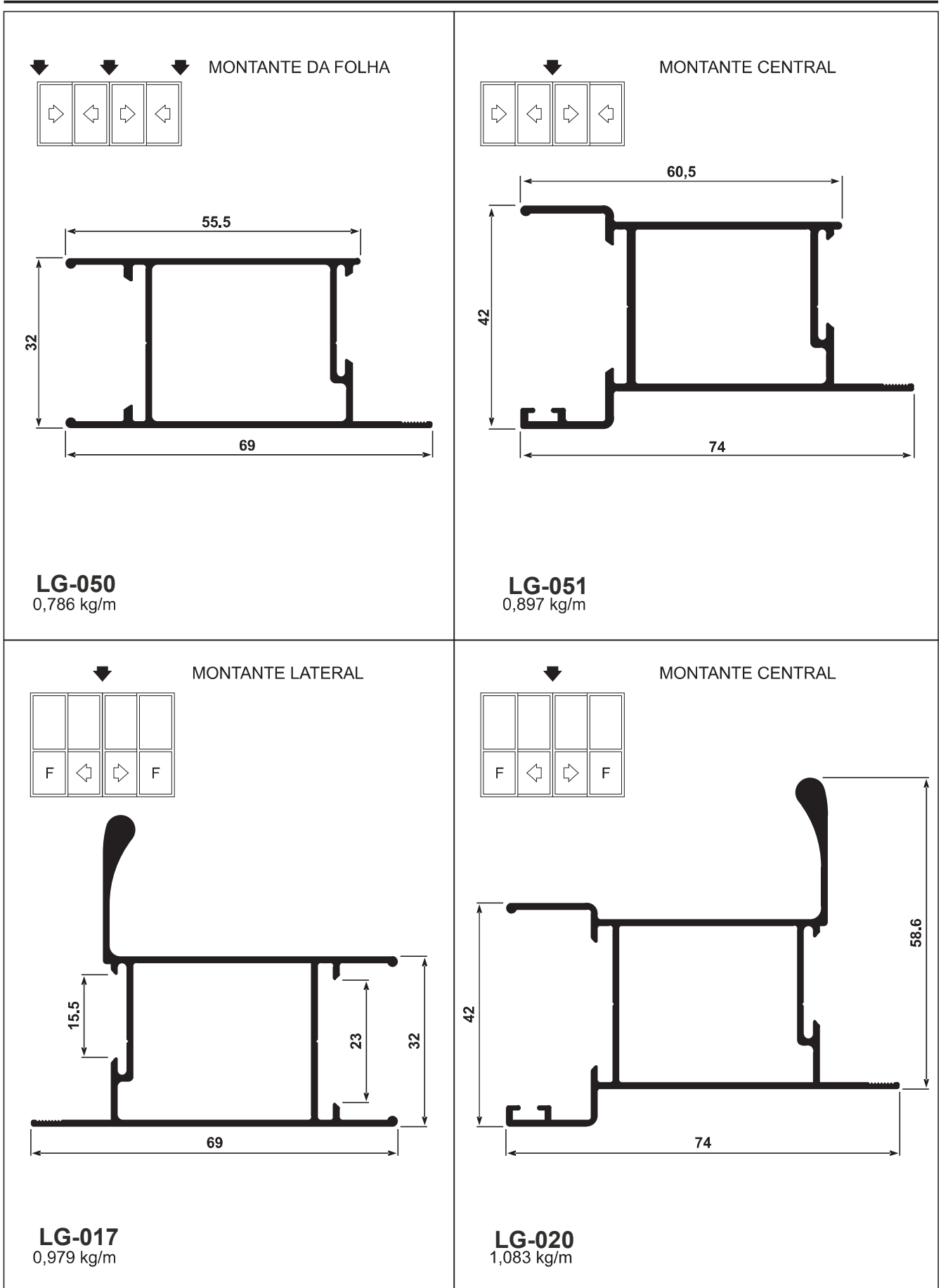

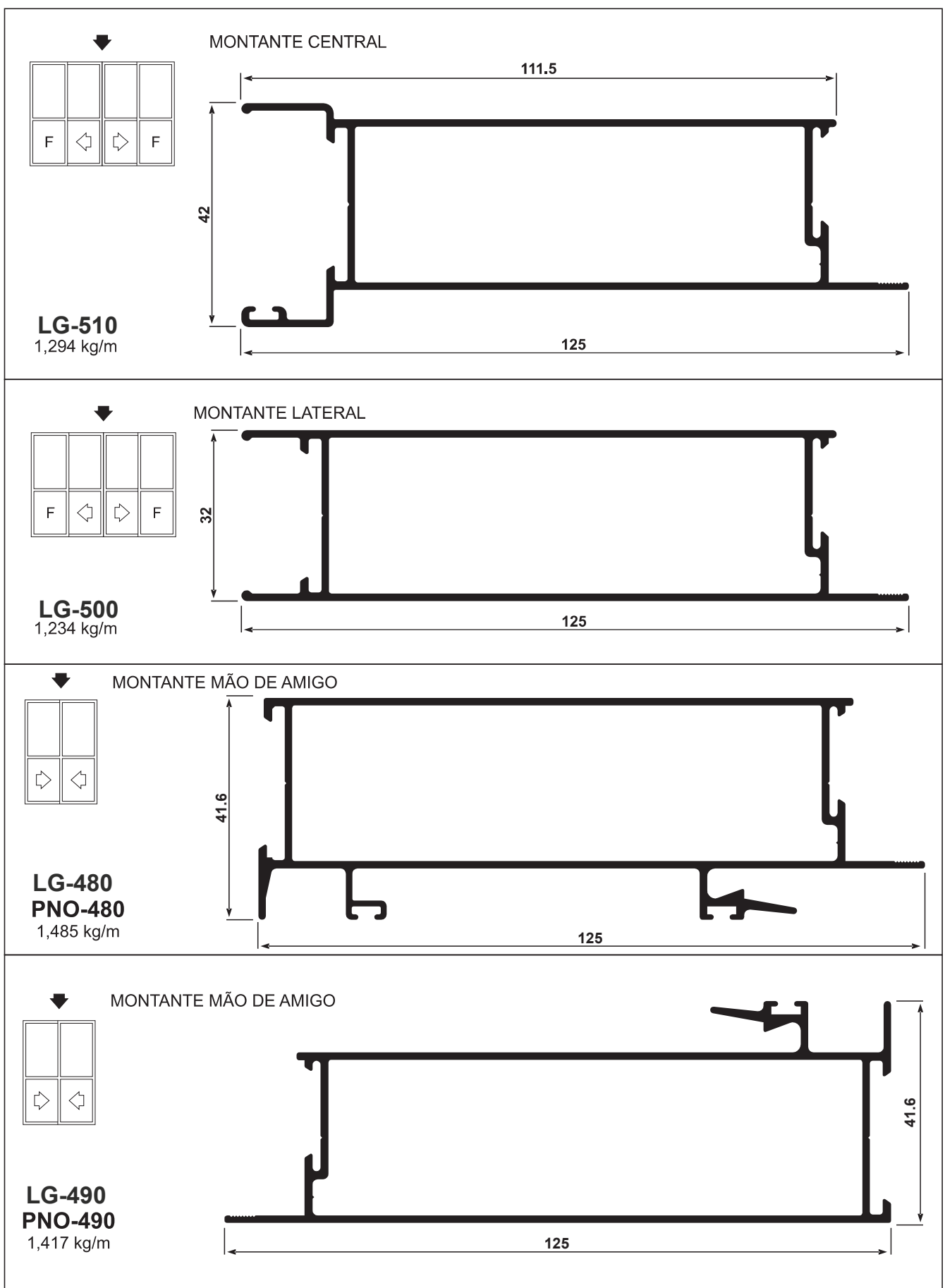

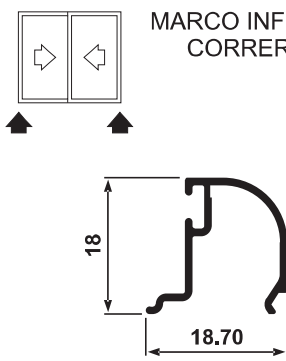
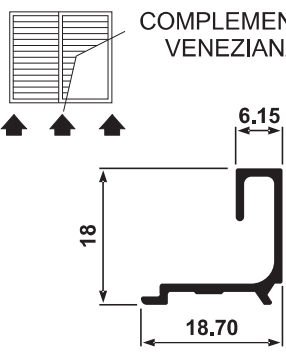
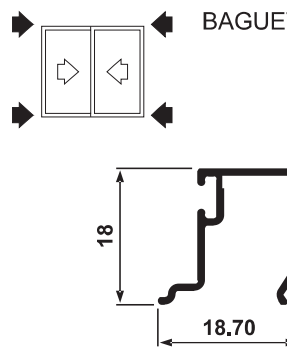
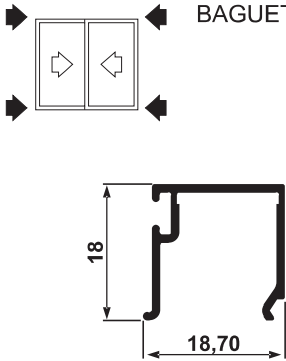
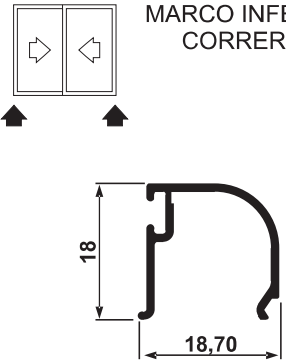
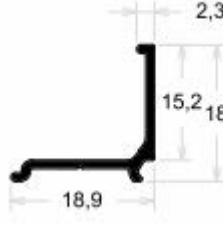
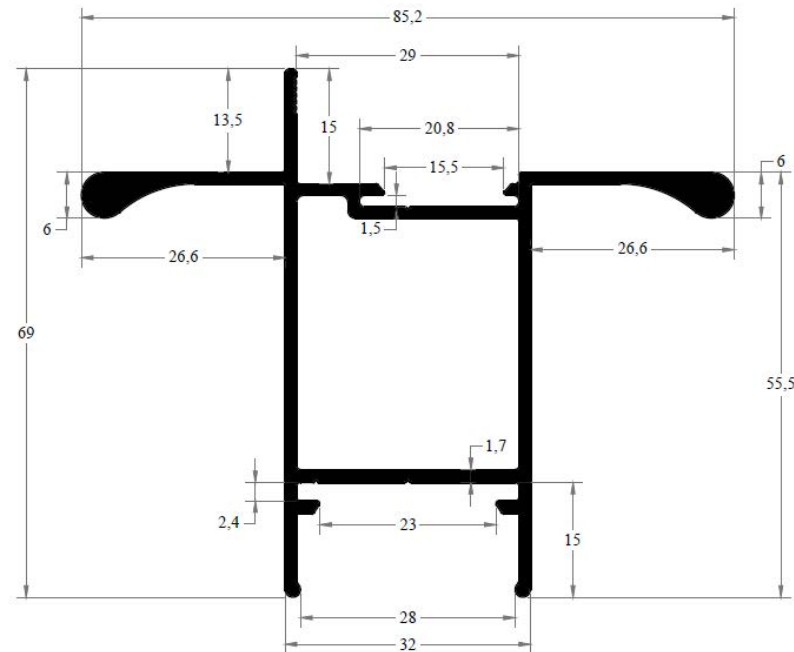
 <p>MARCO INFERIOR CORRER / 2</p> <p>LG-026 0,158 kg/m</p>	 <p>COMPLEMENTO VENEZIANA</p> <p>LG-027 0,149 kg/m</p>	 <p>BAGUETE</p> <p>LG-057 0,167 kg/m</p>
 <p>BAGUETE</p> <p>LG-059 0,169 kg/m</p>	 <p>MARCO INFERIOR CORRER / 2</p> <p>LG-164 0,160 kg/m</p>	 <p>LG-015 0,114kg/m</p>
 <p>LG-299 1,193kg/m</p>		

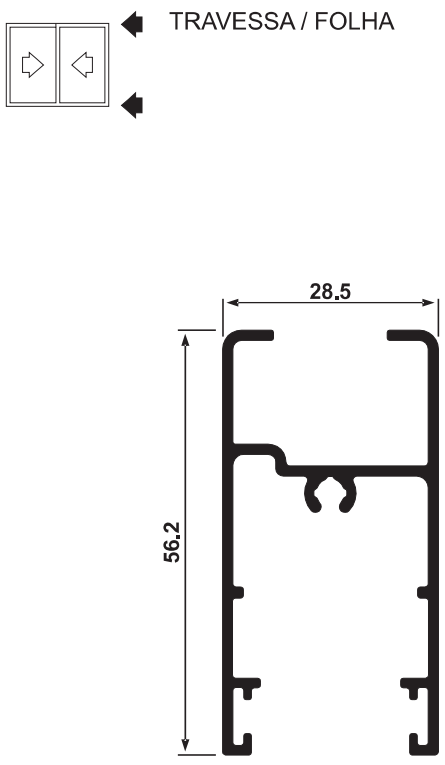
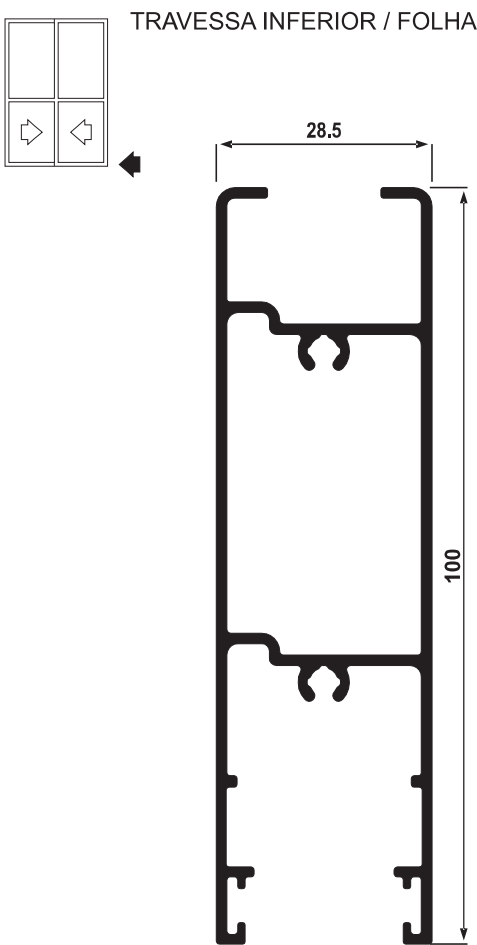
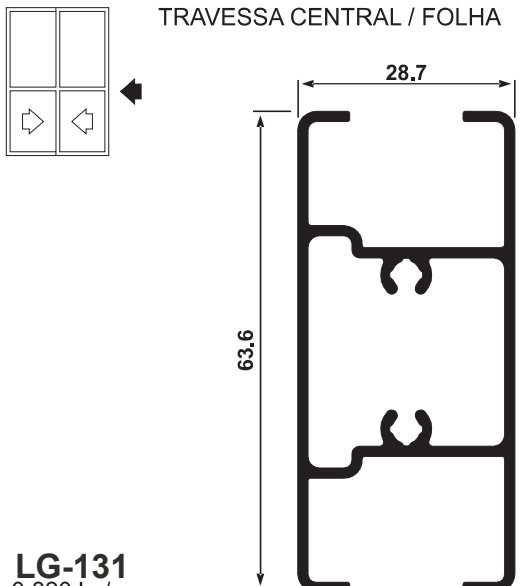
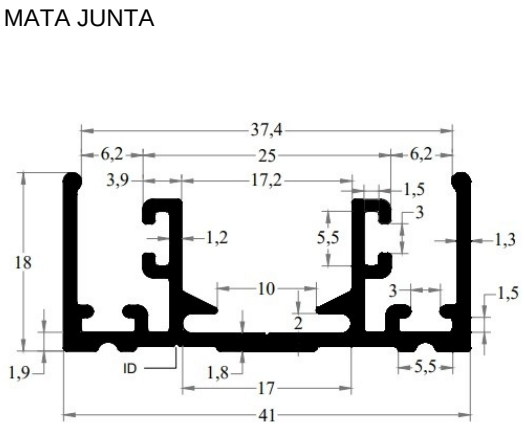

 <p>TRAVESSA / FOLHA</p> <p>LG-130 0,661 kg/m</p>	 <p>TRAVESSA INFERIOR / FOLHA</p> <p>LG-129 1,192 kg/m</p>
 <p>TRAVESSA CENTRAL / FOLHA</p> <p>LG-131 0,820 kg/m</p>	 <p>MATA JUNTA</p> <p>LG-029 0,496 kg/m</p>



↓
MONTANTE MÃO DE AMIGO

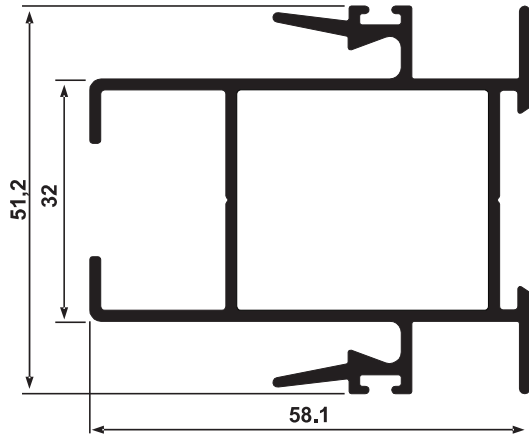
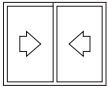

LG-163
1,074 kg/m

↓
MONTANTE MÃO DE AMIGO

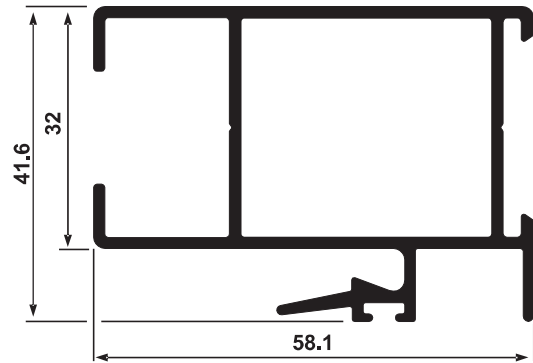
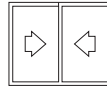

LG-128
0,893 kg/m

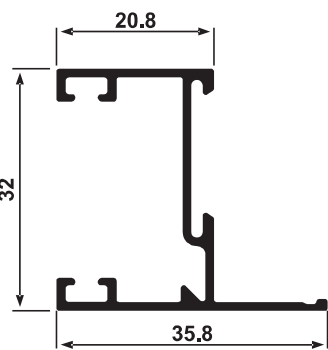
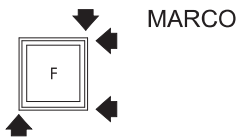

LG-083
0,397 kg/m

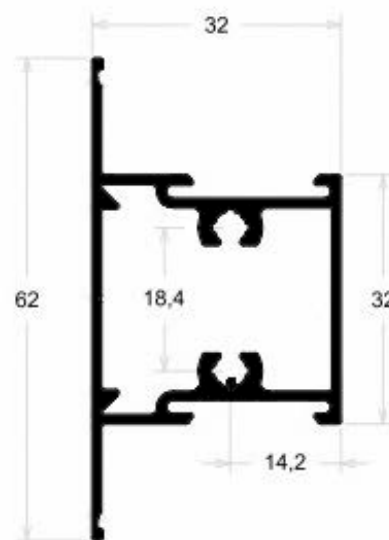

LG-079
0,696 kg/m



MONTANTE DA FOLHA

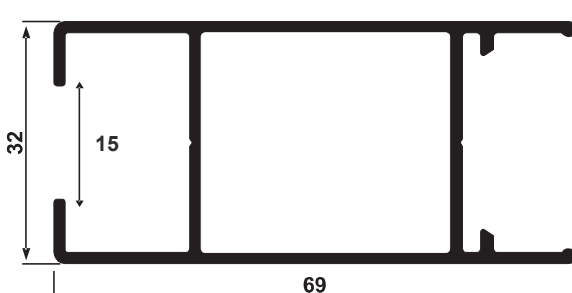

LG-132
0,837 kg/m

MONTANTE CENTRAL

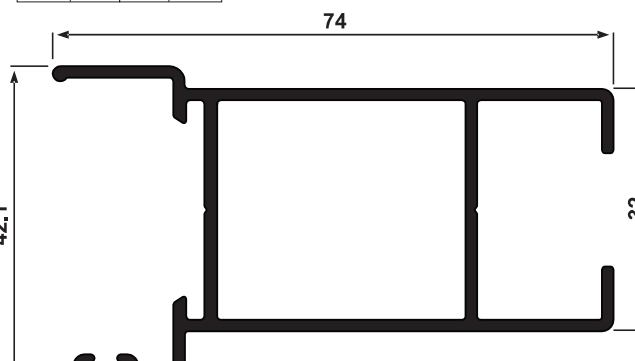

LG-133
0,922 kg/m

MONTANTE CENTRAL FOLHA

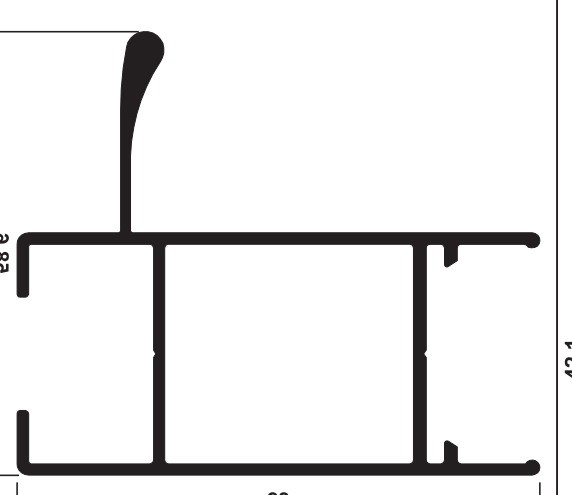

LG-126
1,044 kg/m

MONTANTE LATERAL DA FOLHA

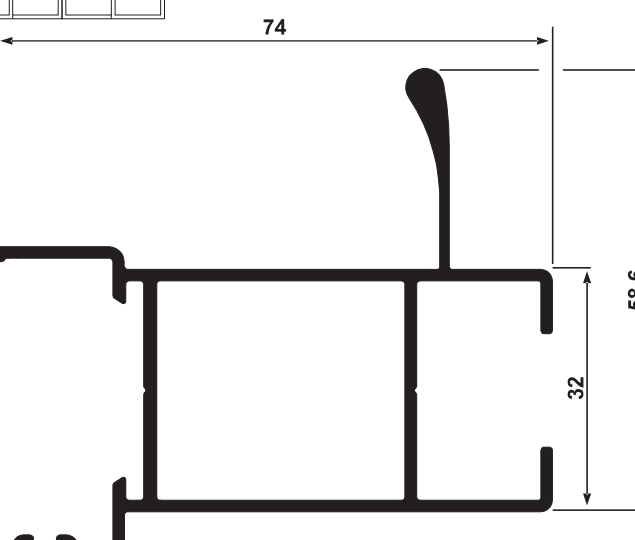

LG-134
1,141 kg/m



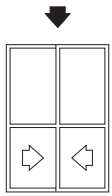

MONTANTE
MÃO DE AMIGO

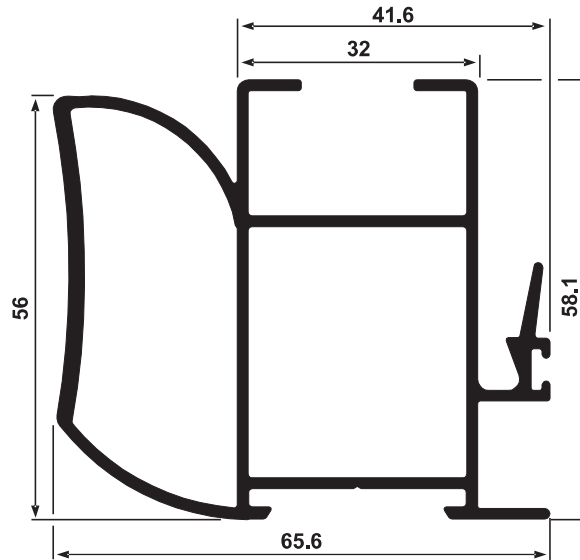

LG-180
1,361 kg/m

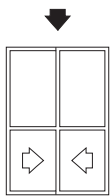



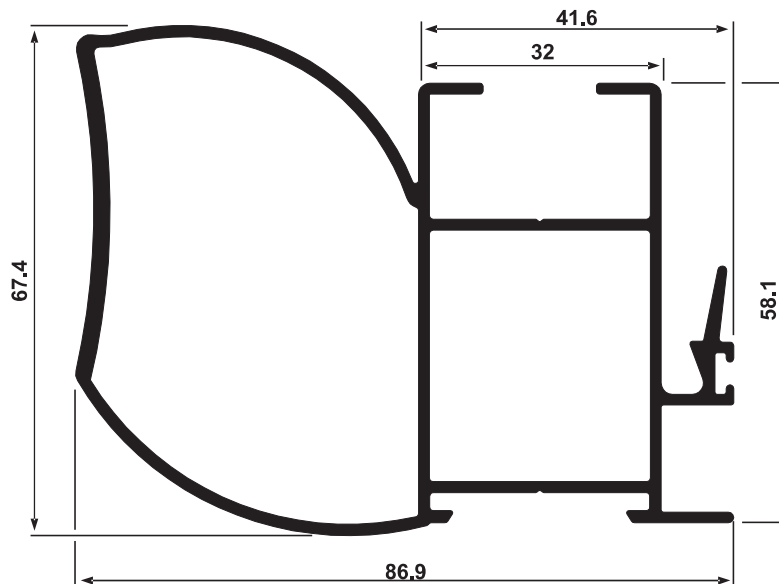

MONTANTE
MÃO DE AMIGO

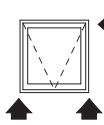
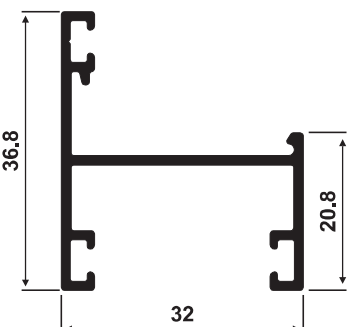
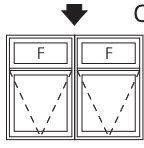
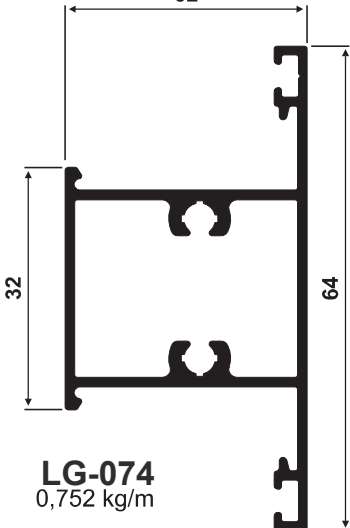
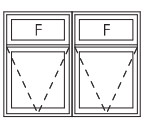
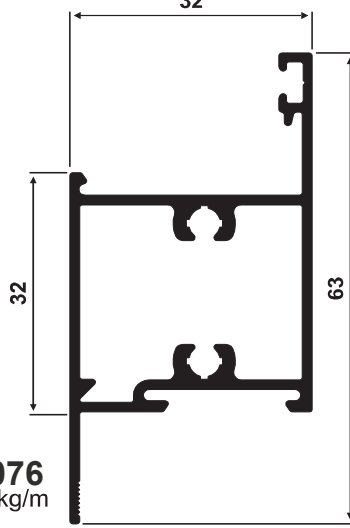
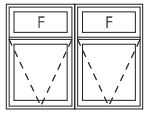
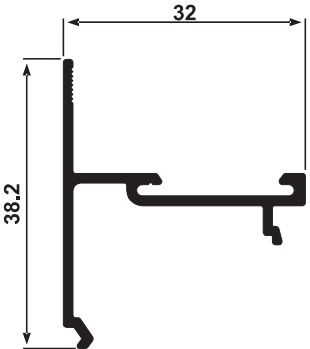

LG-127
1,607 kg/m

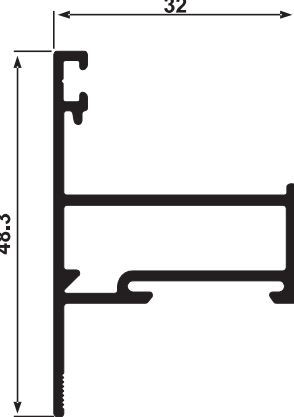

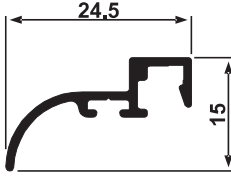
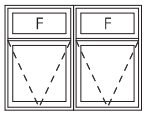
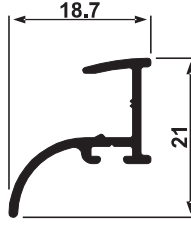
 <p>MARCO</p>  <p>36.8 32 20.8</p> <p>LG-068 0,405 kg/m</p>	 <p>COLUNA / MARCO</p>  <p>32 32 64</p> <p>LG-074 0,752 kg/m</p>	 <p>TRAVESSA</p>  <p>32 32 63</p> <p>LG-076 0,756 kg/m</p>
 <p>INVERSOR PARA BAGUETE</p>  <p>32 38.2</p> <p>LG-077 0,317 kg/m</p>	 <p>FOLHA</p>  <p>32 48.3</p> <p>LG-085 0,515 kg/m</p>	
 <p>PINGADEIRA</p>  <p>24,5 15</p> <p>LG-091 0,148 kg/m</p>	 <p>PINGADEIRA</p>  <p>18,7 21</p> <p>LG-092 0,151 kg/m</p>	



LG-016
0,277 kg/m

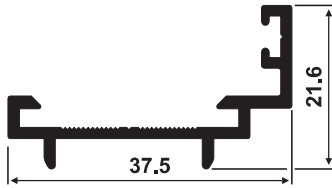

LG-043
0,808 kg/m

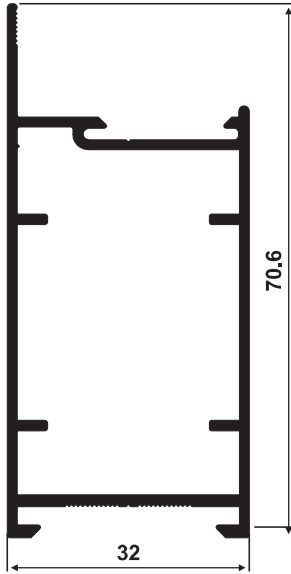

LG-042
1,059 kg/m

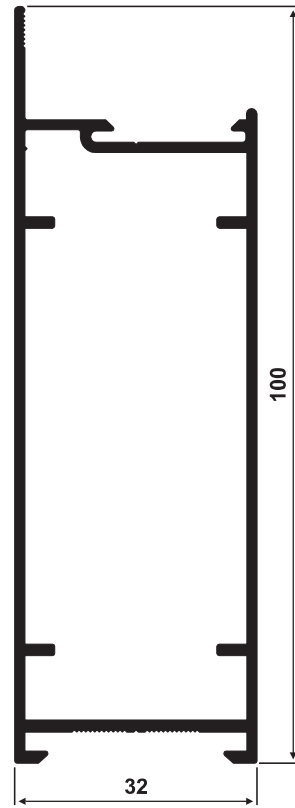

LG-022
1,032 kg/mt

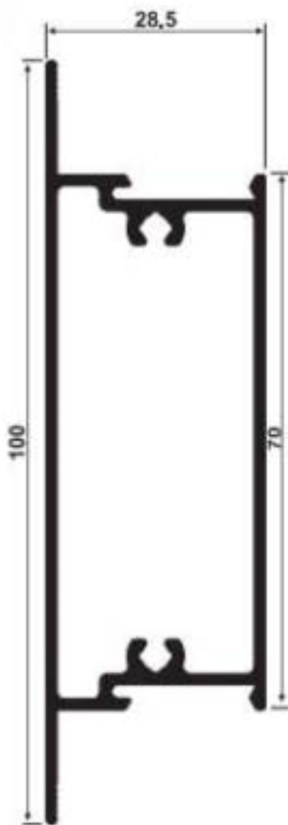

LG-056
0,598 kg/m

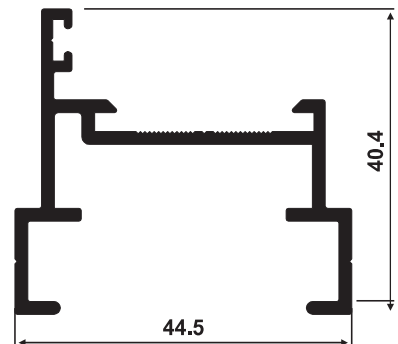

LG-058
0,713 kg/m

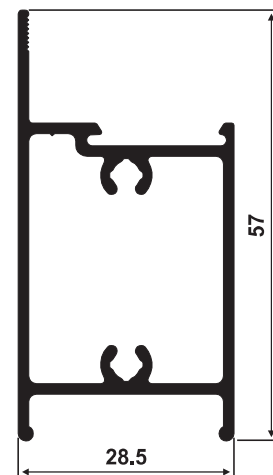

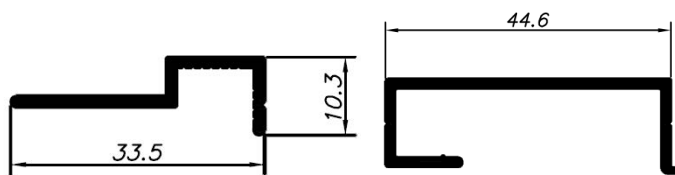
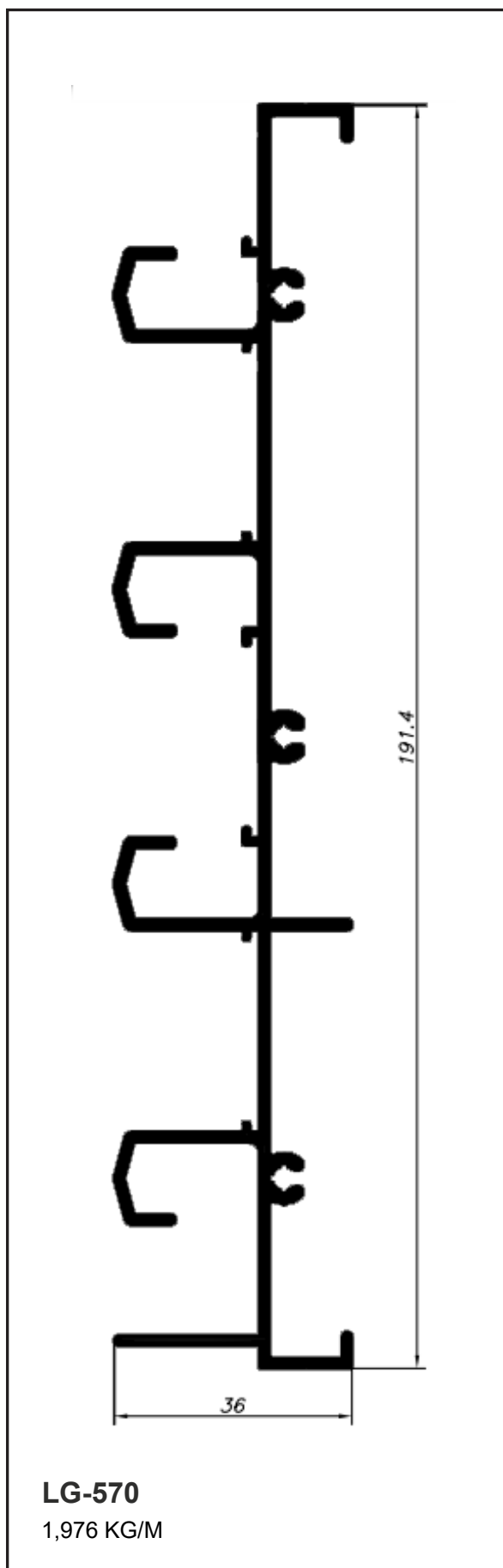

LG-571
0,165 KG/M

LG-572
0,343 KG/M

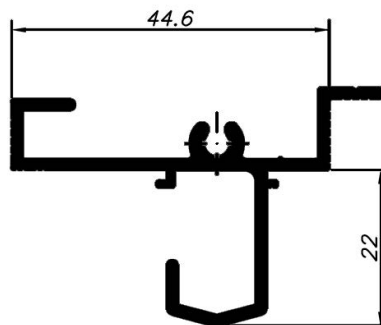

LG-574
0,561 KG/M

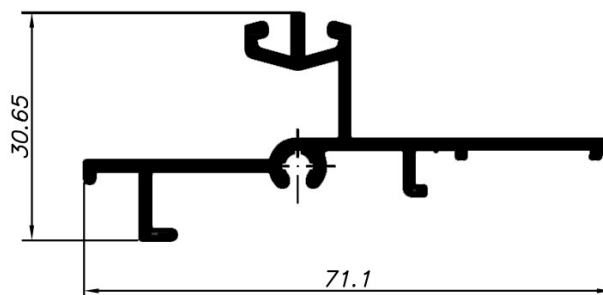

LG-573
0,612 KG/M

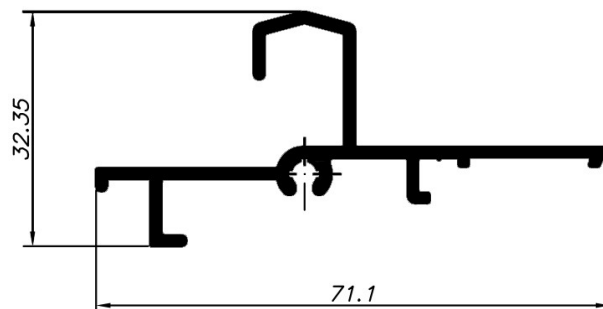

LG-575
0,595 KG/M



Linha *Nobile 3.2*
Minimalista

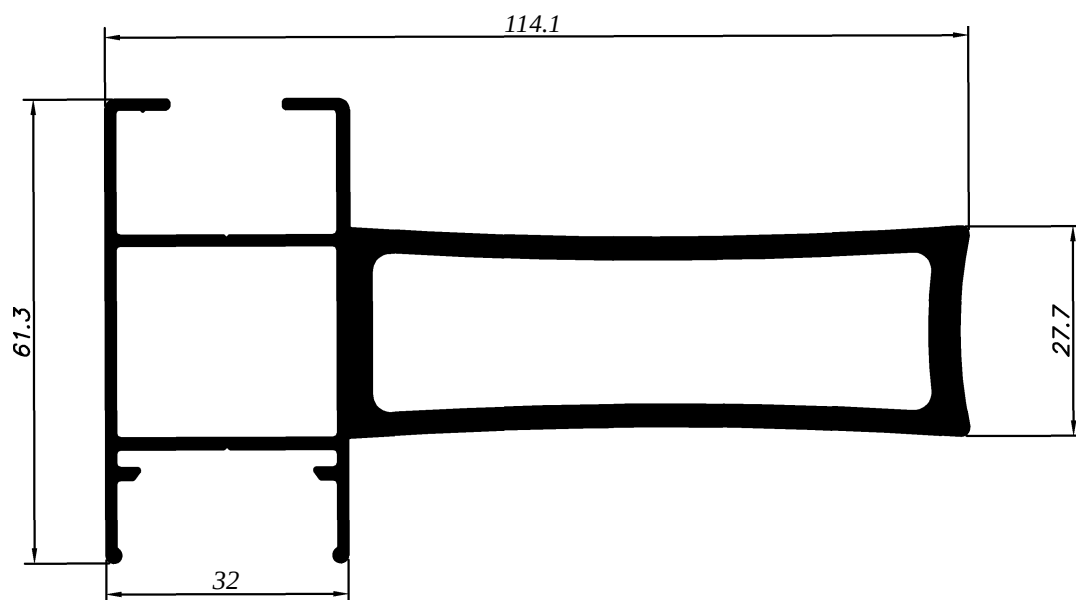

LG-626
2,599 Kg/m

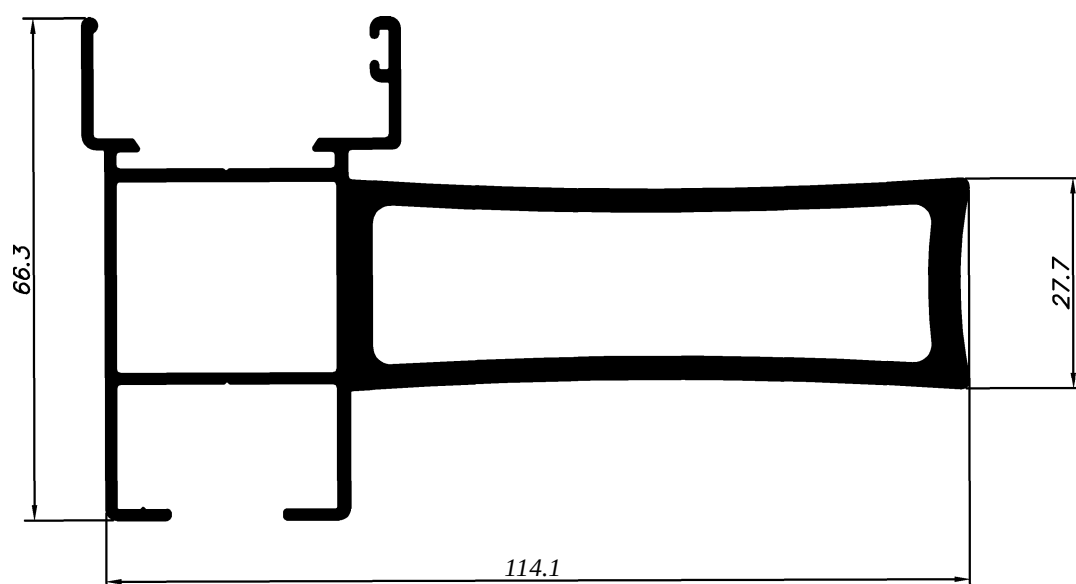

LG-634
2,695 Kg/m



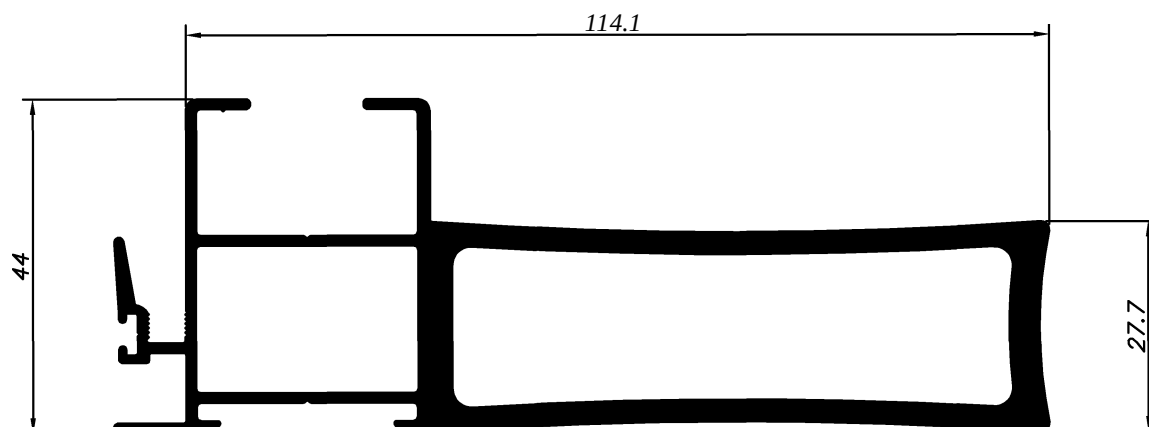

LG-627
2,571 Kg/m

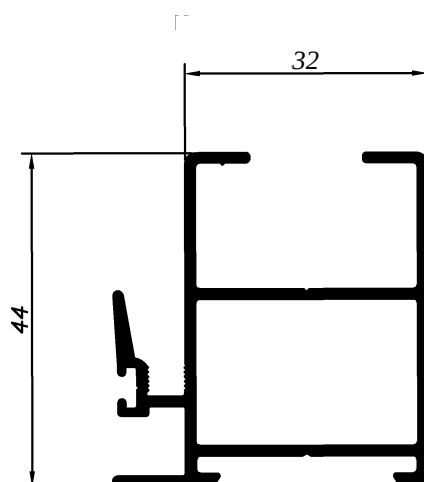

LG-628
0,758 Kg/m

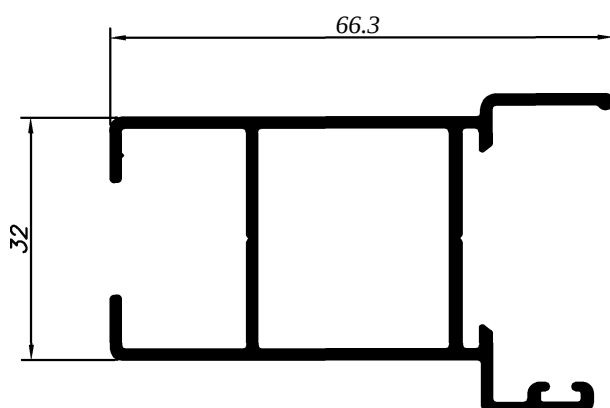

LG-633
0,877 Kg/m

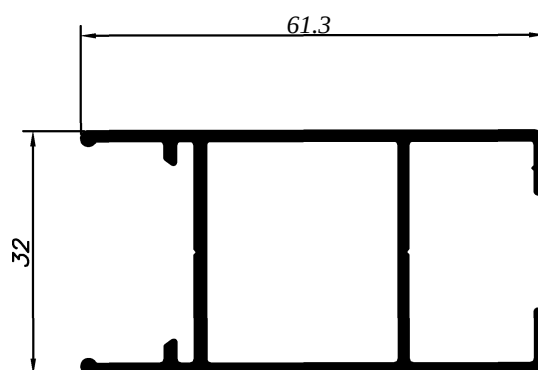

LG-632
0,789 Kg/m



Linha Nobile 3.2
Minimalista

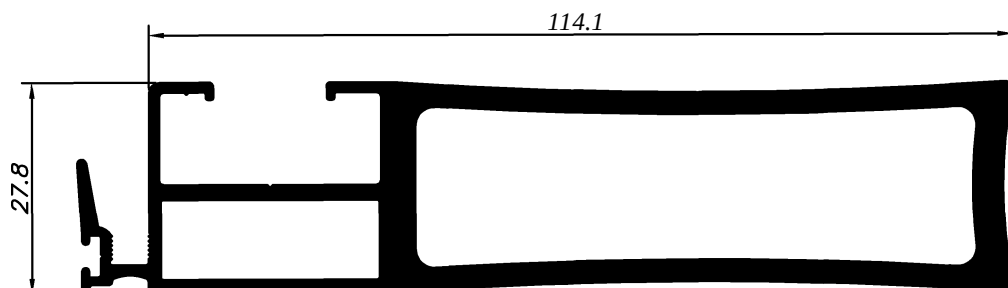

LG-637
2,511 Kg/m

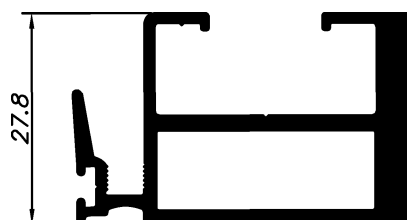

LG-638
0,980 Kg/m



Marco Superior - Vidro Colado

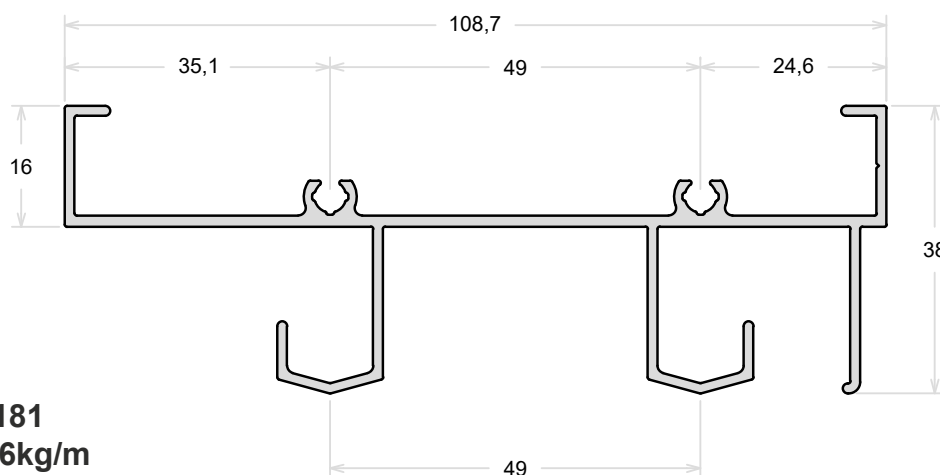

LG-181
1,026kg/m

LG - 112
0,095 Kg/m

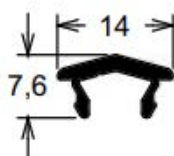

Marco Inferior - Vidro Colado

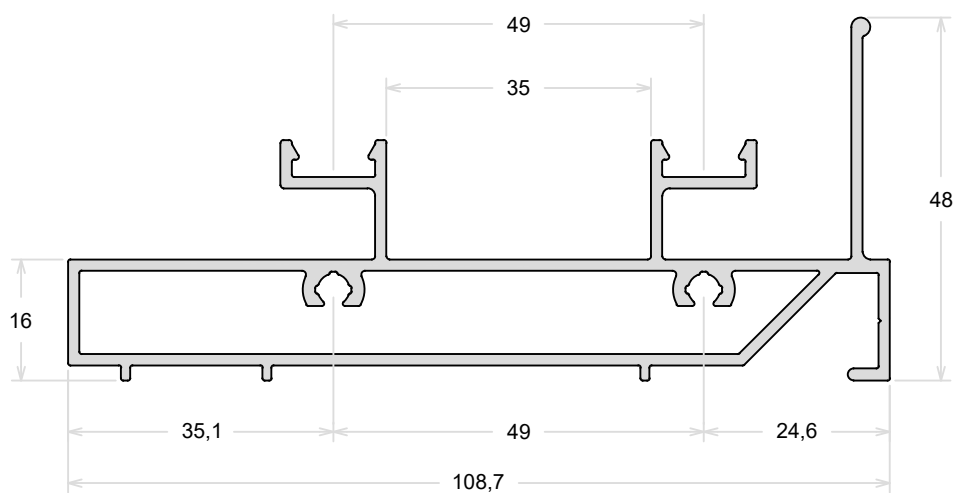

LG-179
1,553kg/m

Mata Junta Central e Lateral
Vidro Colado

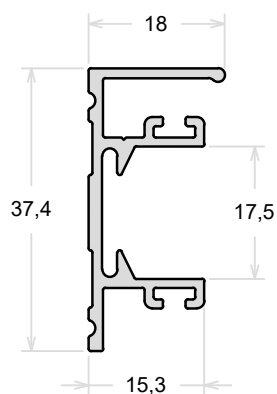

LG - 188
0,389 Kg/m

Pingadeira Externa - Vidro Colado

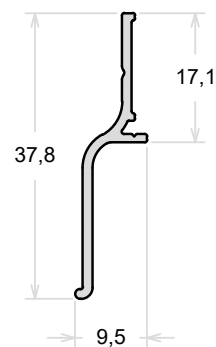

LG - 193
0,157 Kg/m

Marco Lateral Vertical - Vidro Colado

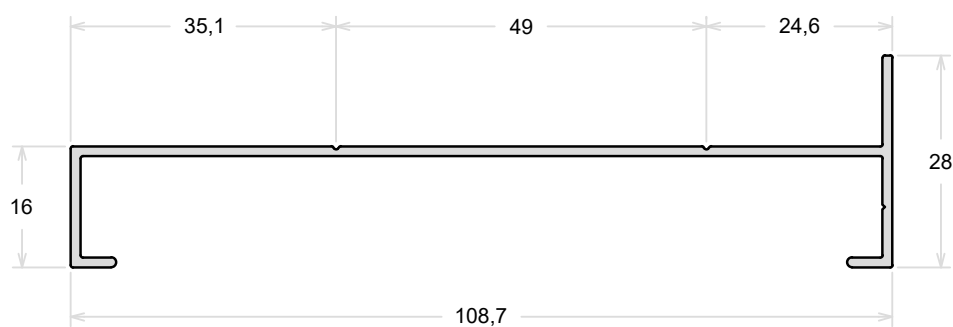

LG - 187
0,561 Kg/m

Folha Inferior e Superior - Vidro Colado

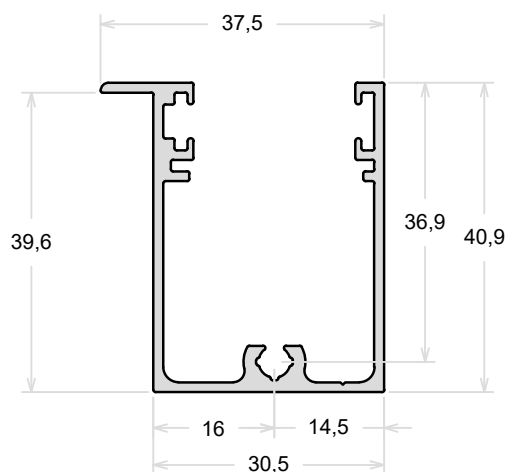

LG - 182
0,575 Kg/m

Travessa Horizontal - Vidro Colado

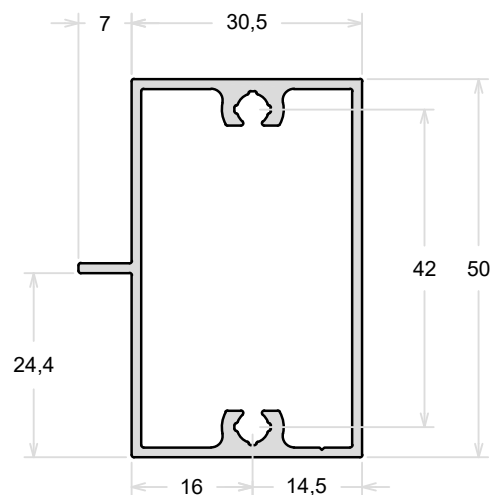

LG - 183
0,706 Kg/m

Folha Inferior- Vidro Colado

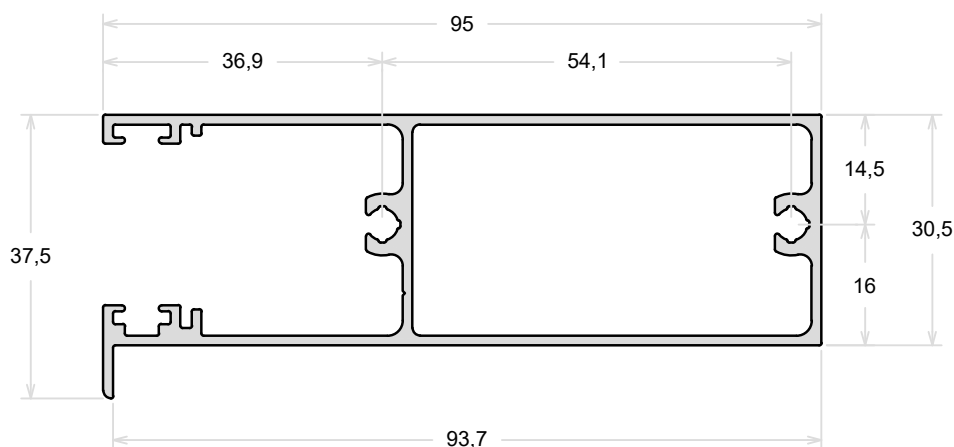

LG - 189
1,127 Kg/m

Folha Lateral Vertical - Vidro Colado

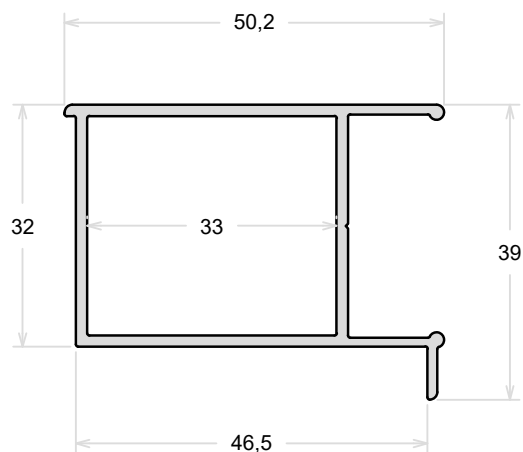

LG - 185
0,651 Kg/m

Folha Lateral c/ Reforço - Vidro Colado

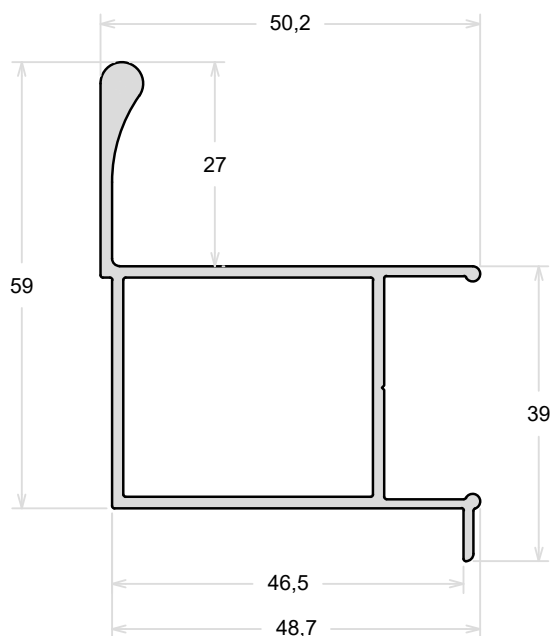

LG - 192
0,838 Kg/m

Mão De Amigo Interno - Vidro Colado

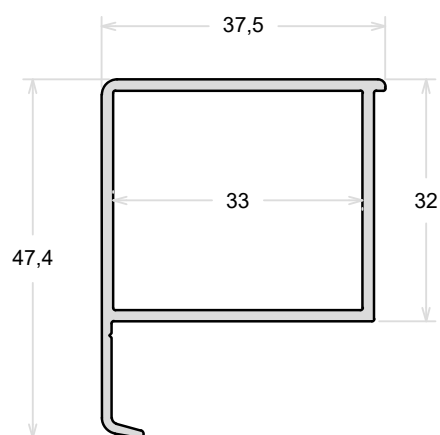

LG - 184
0,597 Kg/m

Folha Mão De Amigo Externo - Vidro Colado

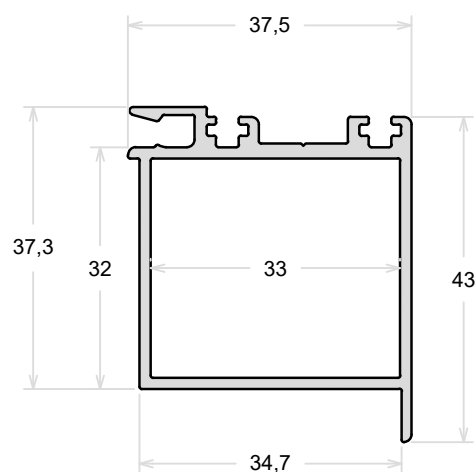

LG - 191
0,709 Kg/m

Mão De Amigo Interno c/ Reforço
Vidro Colado

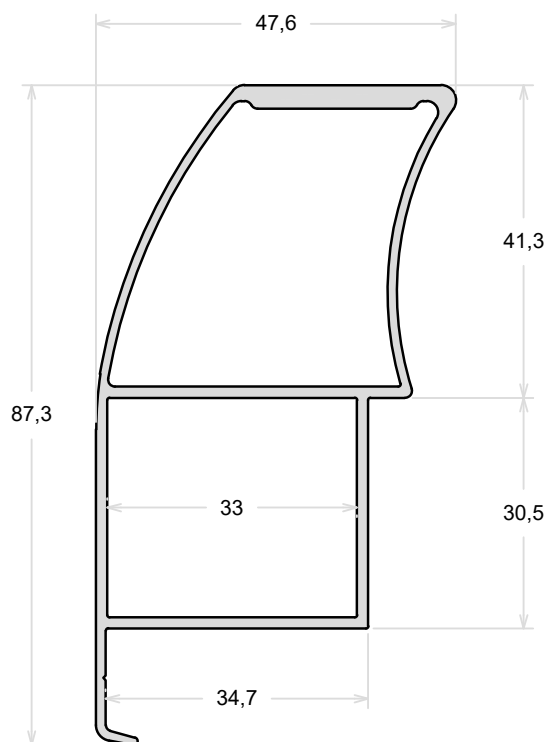

LG - 190
1,113 Kg/m

Mão De Amigo Externo c/ Reforço
Vidro Colado

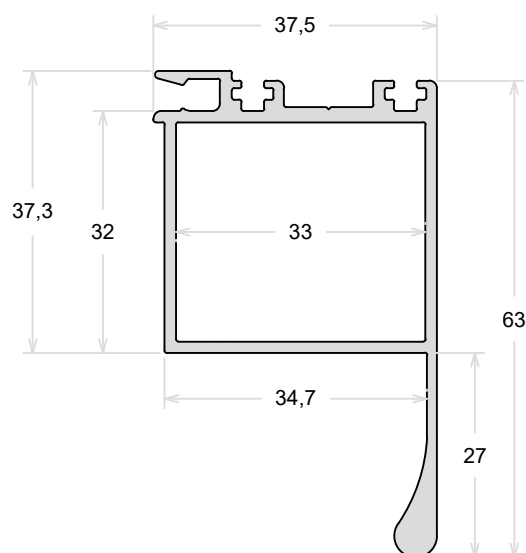

LG - 186
0,863 Kg/m

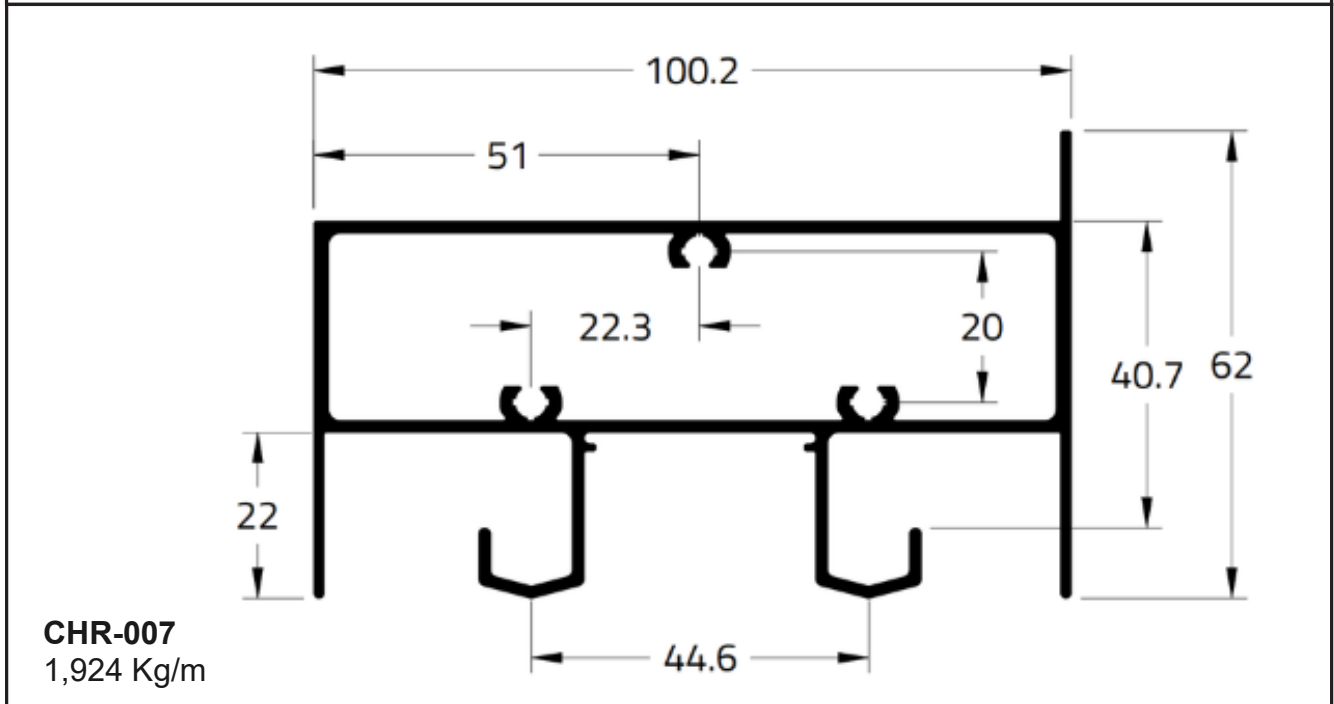
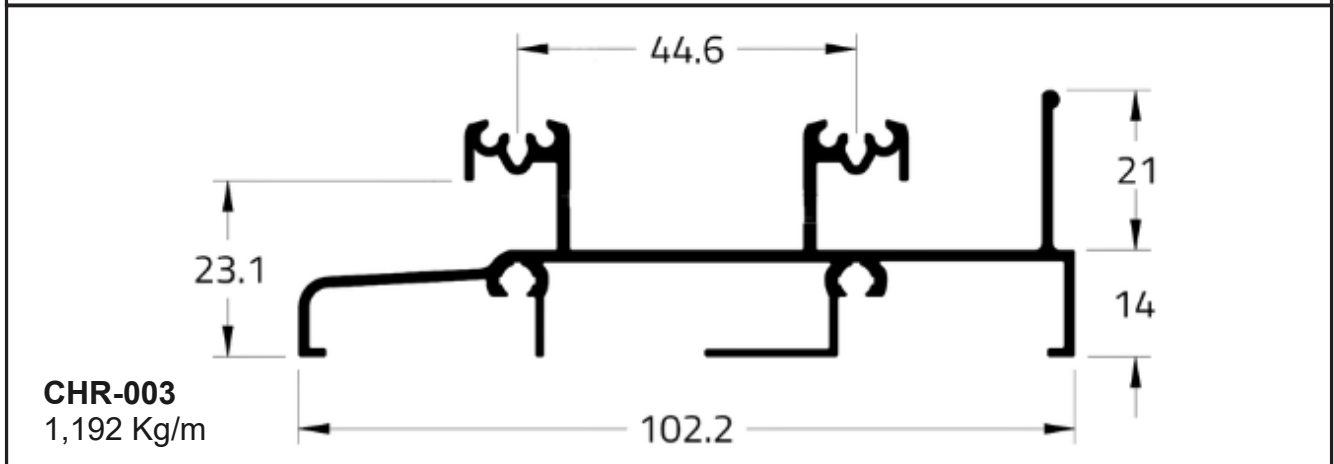
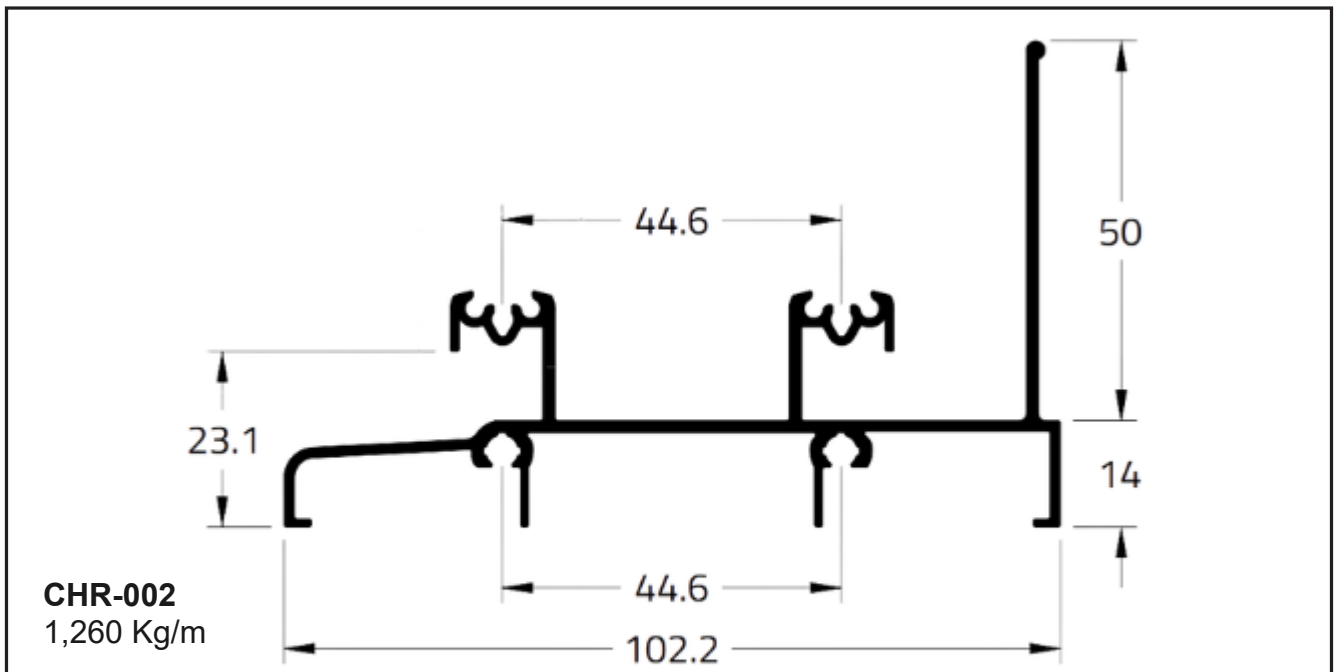

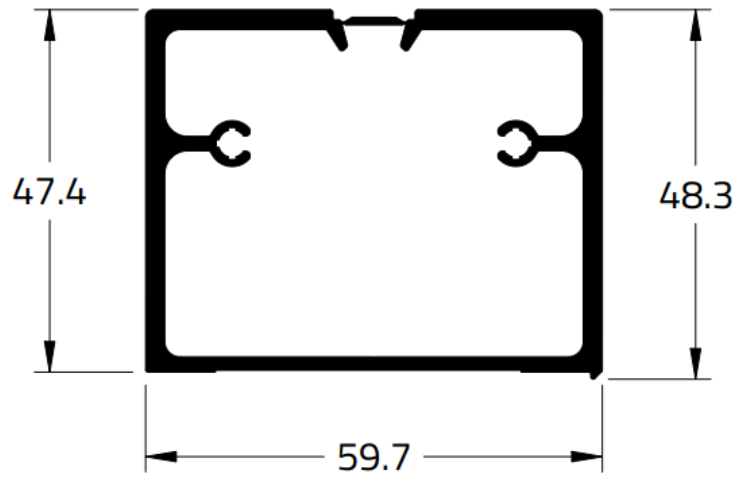

CHR-006
1,477 Kg/m



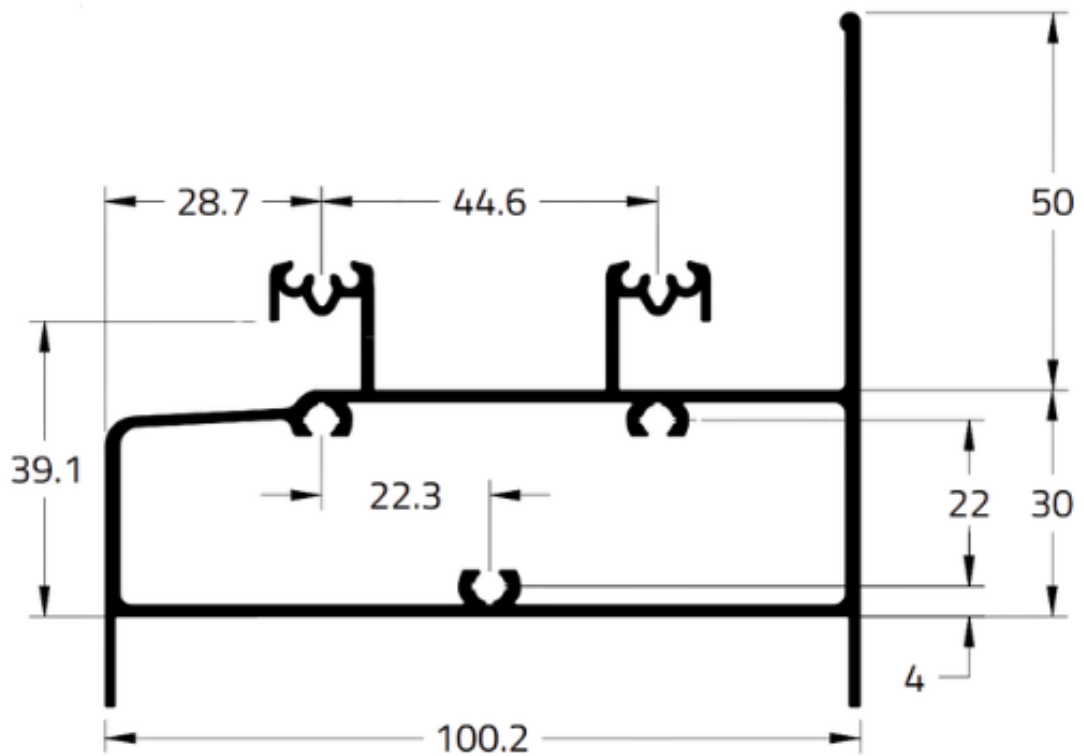

CHR-008
2,058 Kg/m

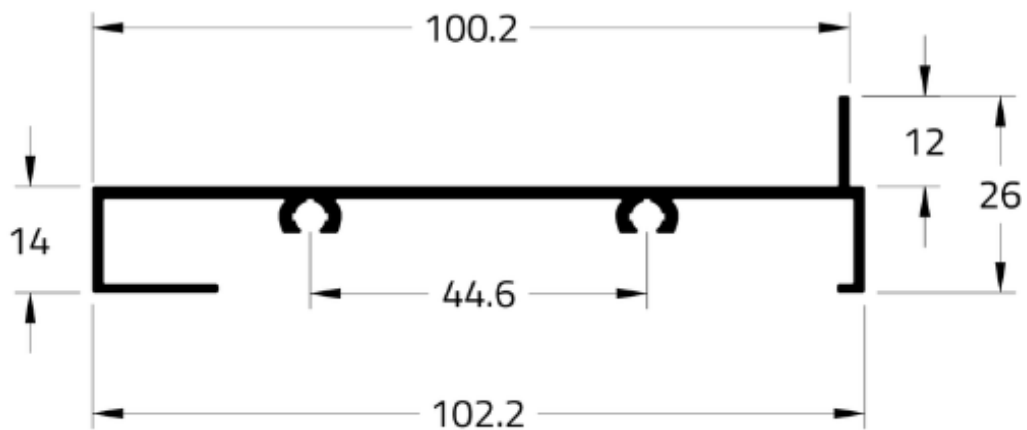

CHR-009
0,769 Kg/m



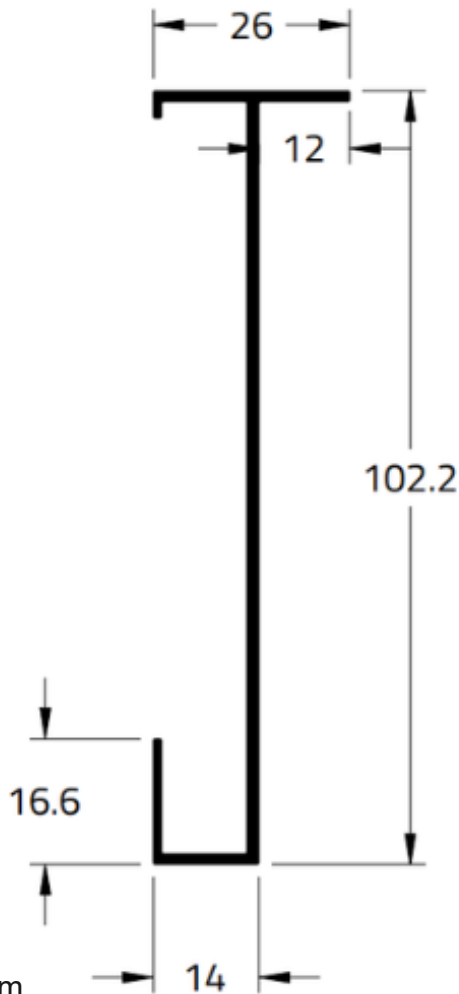

CHR-010
0,657 Kg/m

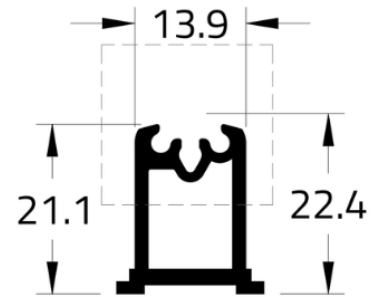

CHR-011
0,362 Kg/m

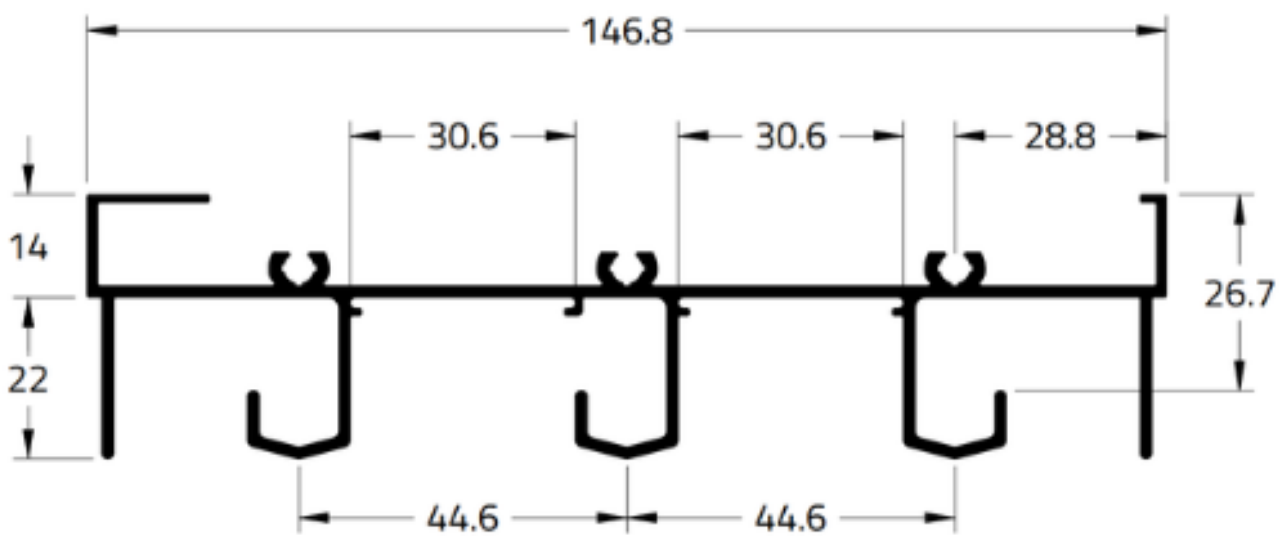

CHR-012
1,727 Kg/m





chroma

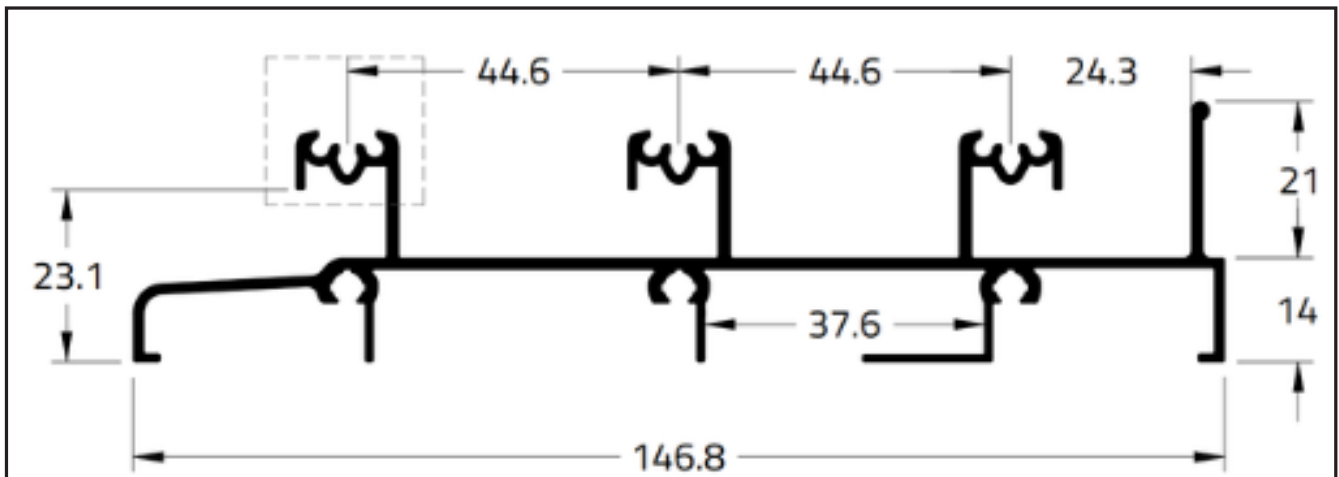

CHR-014
1,652 Kg/m

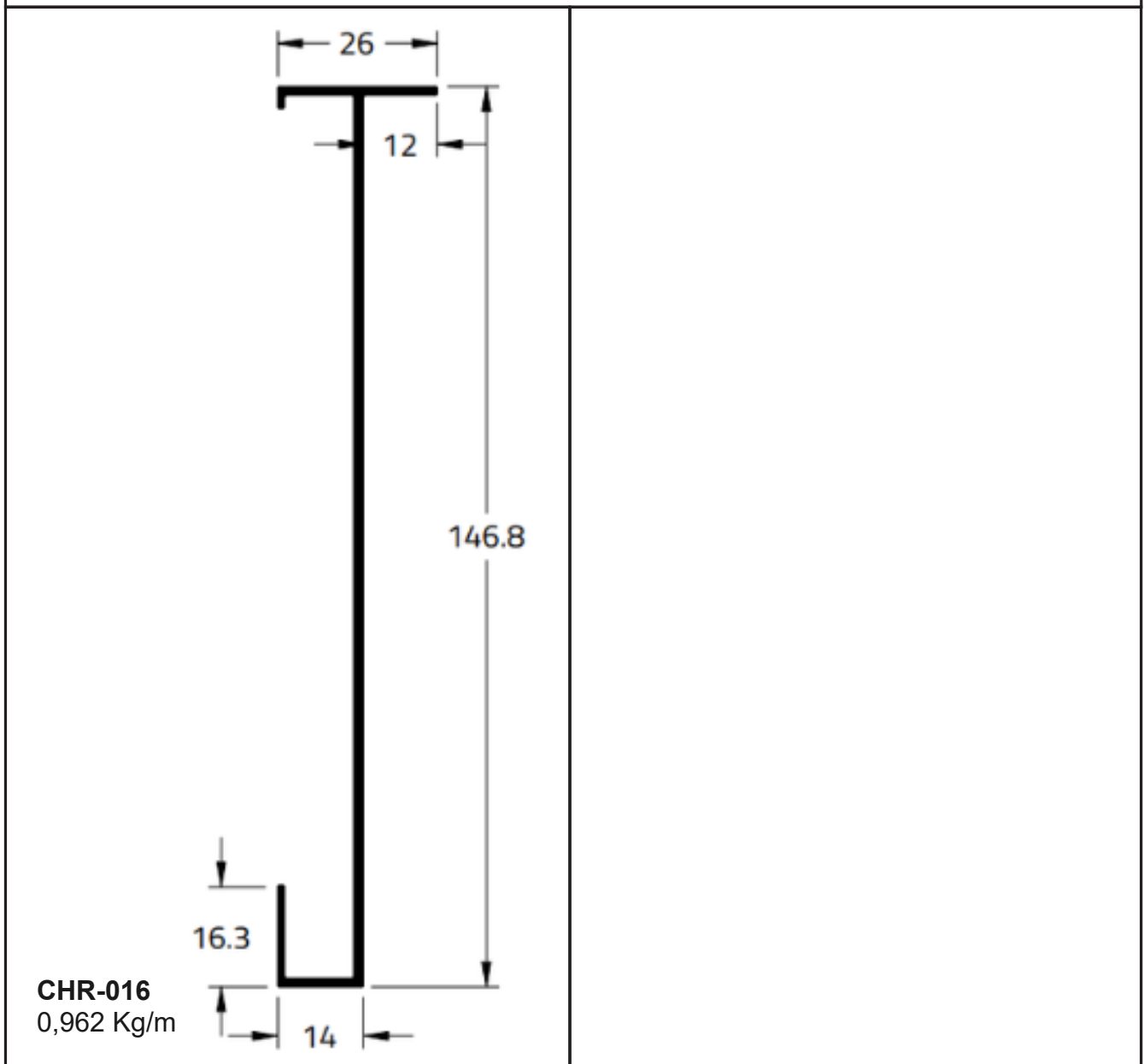

CHR-016
0,962 Kg/m



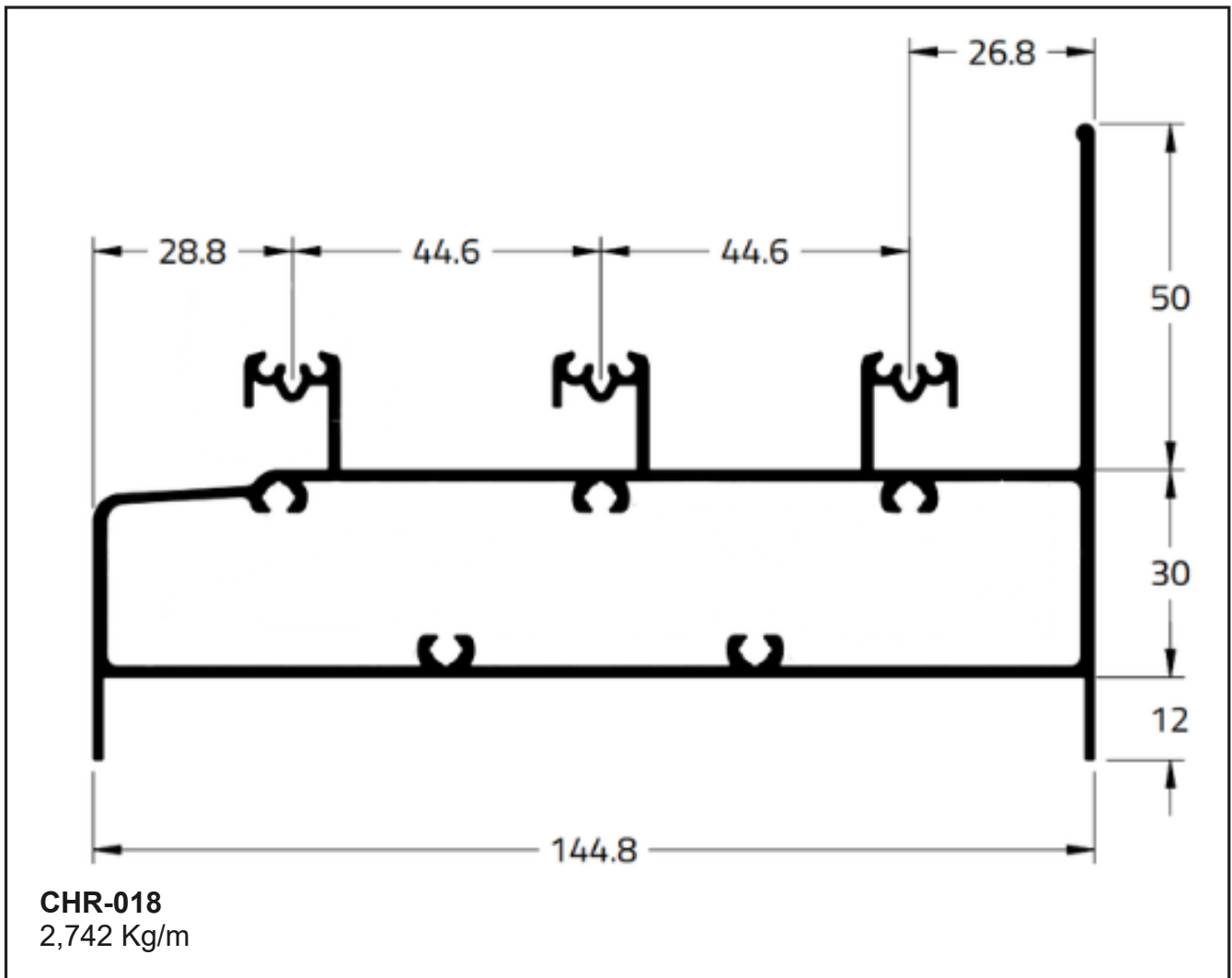

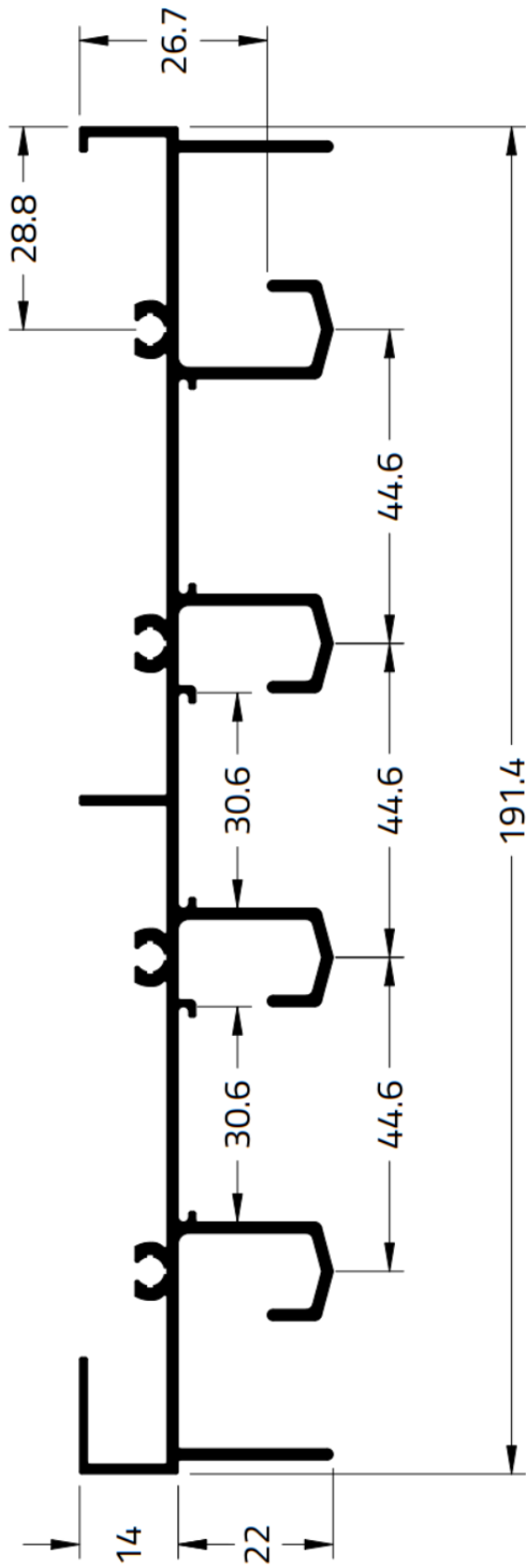

CHR-019
2,312 Kg/m

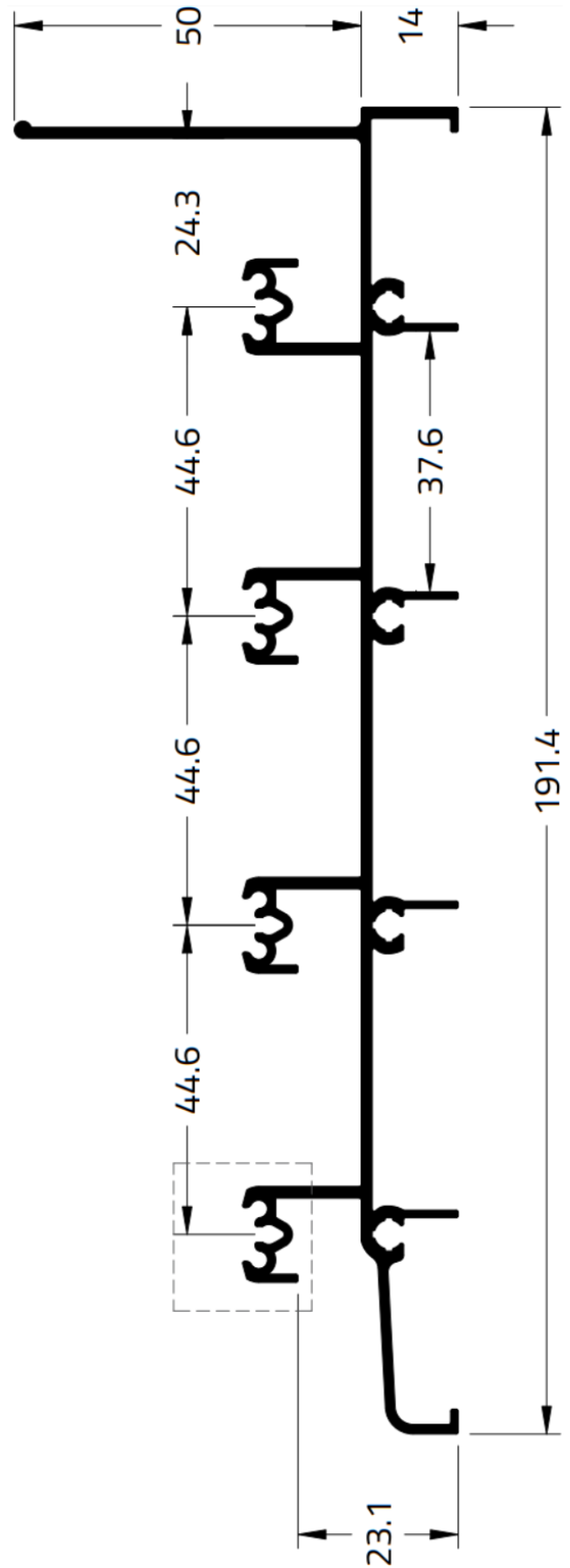

CHR-020
2,199 Kg/m

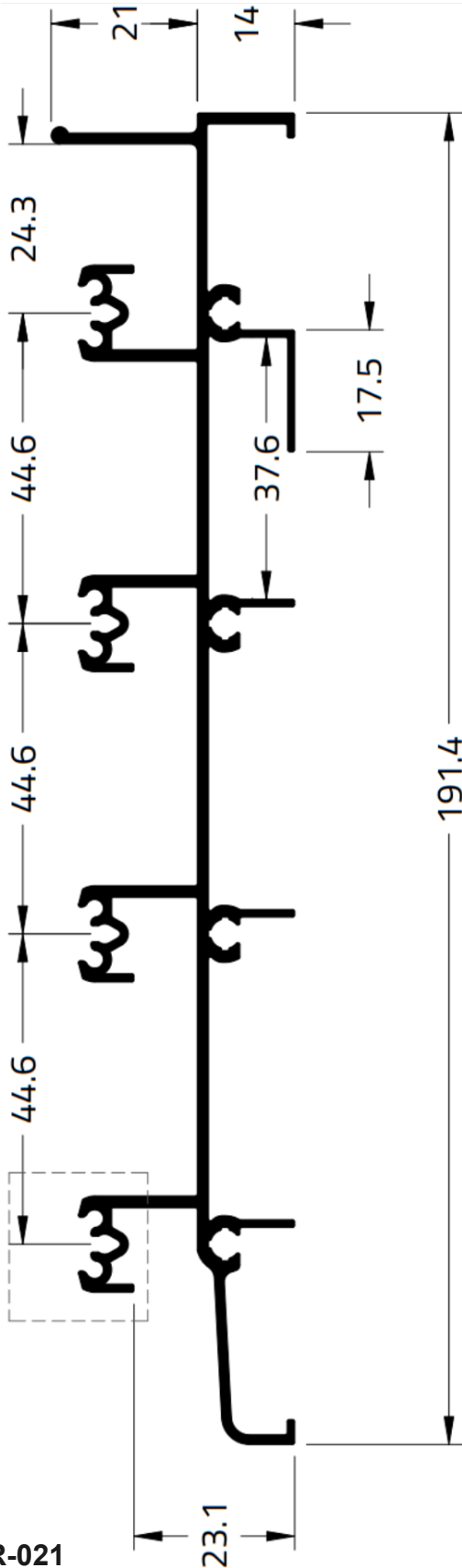

CHR-021
2,190 Kg/m

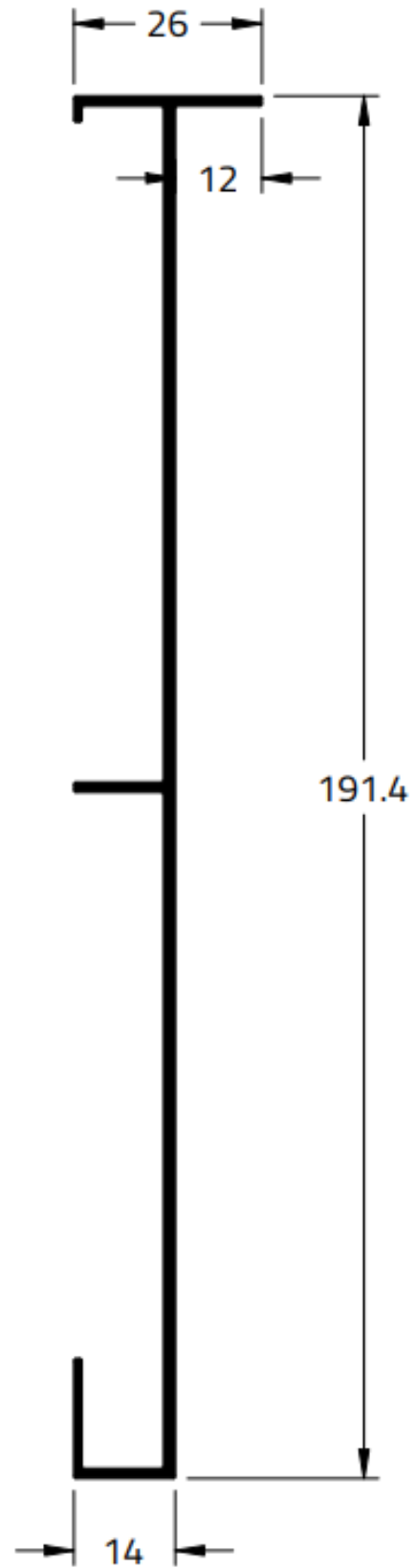

CHR-023
1,219 Kg/m

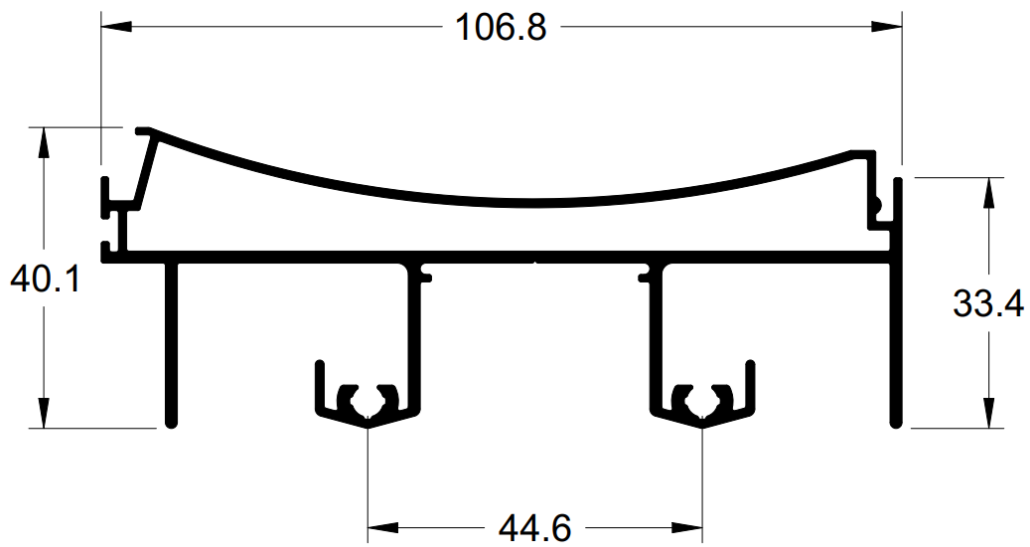

CHR-022
1,571 Kg/m



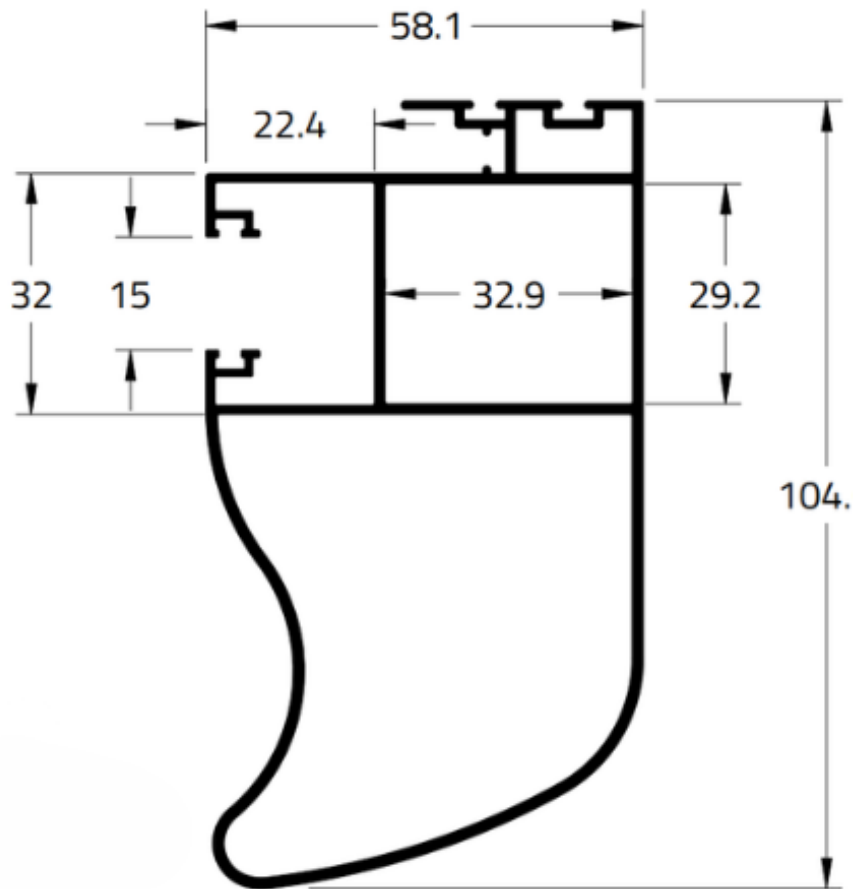

CHR-026
1,687 Kg/m

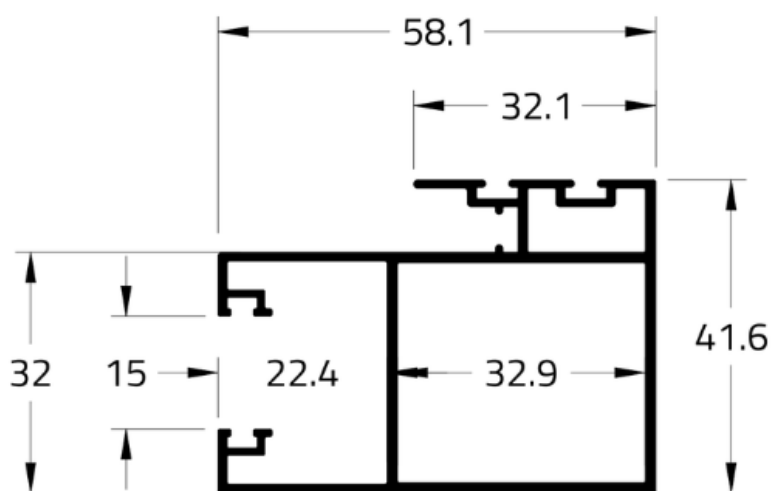

CHR-027
0,990 Kg/m



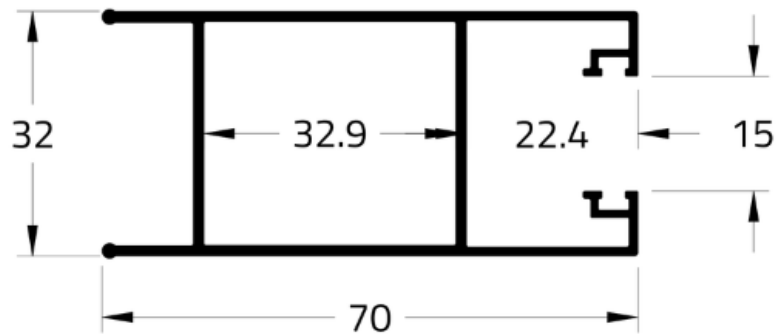

CHR-028
0,941 Kg/m

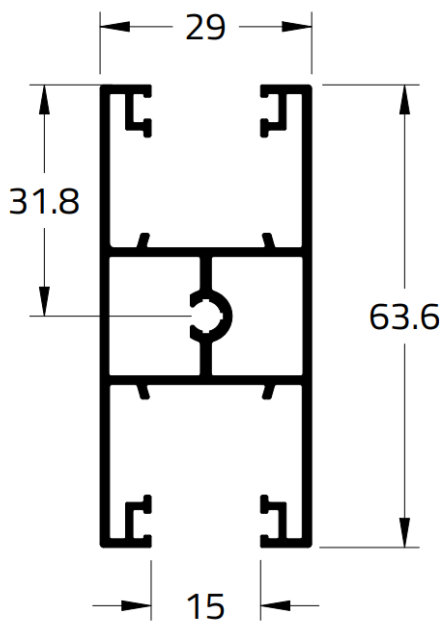

CHR-031
0,976 Kg/m

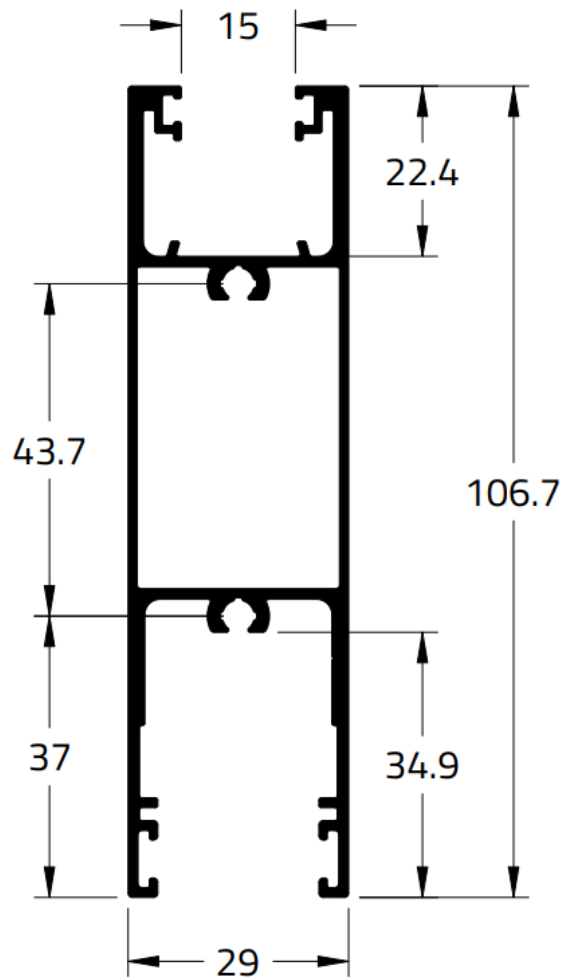

CHR-032
1,442 Kg/m



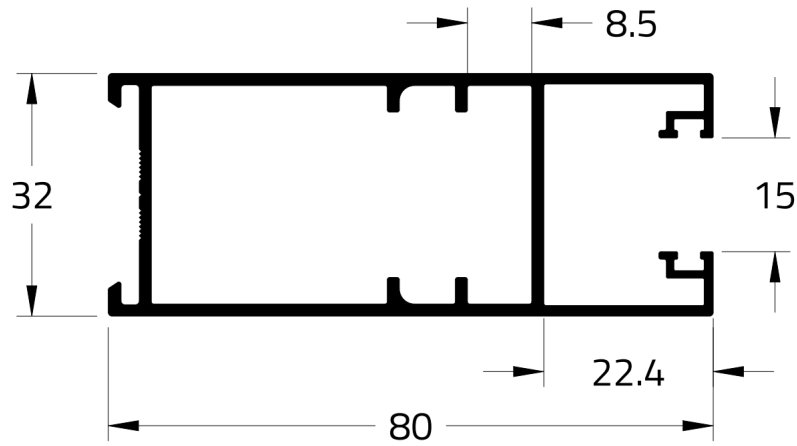

CHR-036
1,133 Kg/m

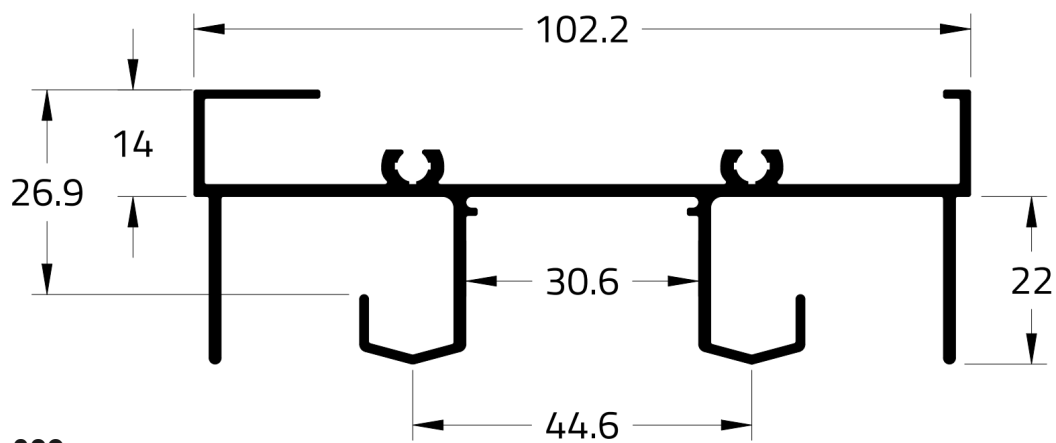

CHR-039
1,233 Kg/m

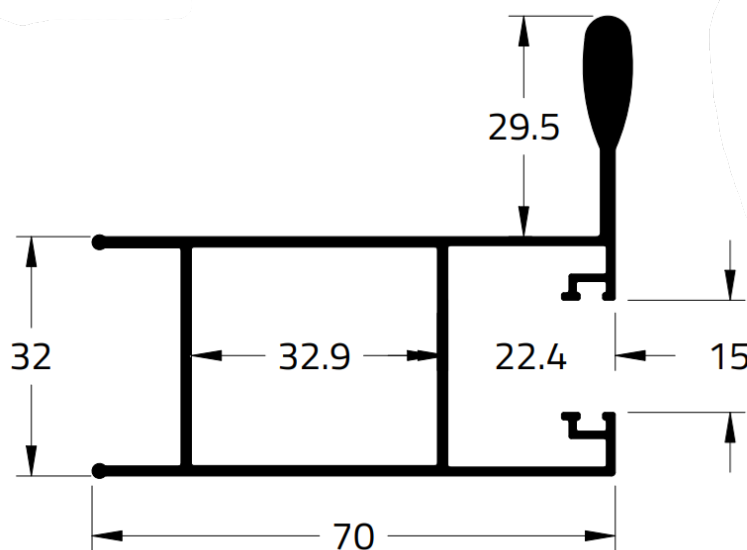

CHR-042
1,184 Kg/m





chroma

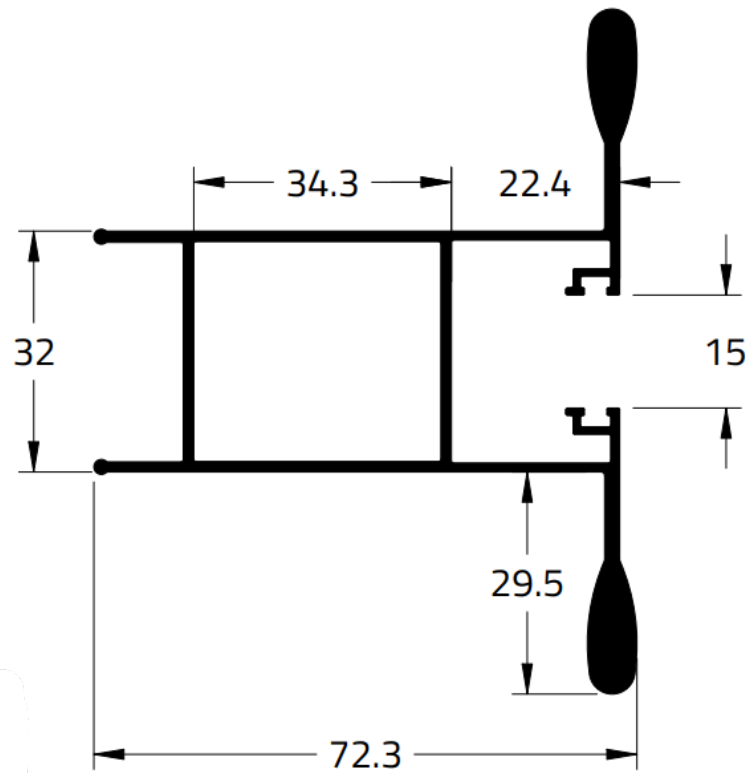

CHR-040
1,515 Kg/m

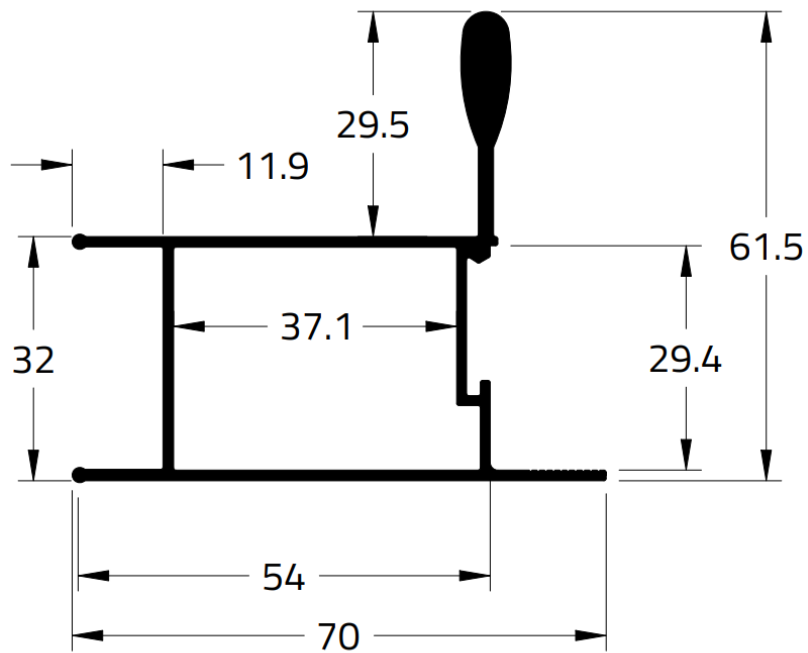

CHR-063
1,076 Kg/m



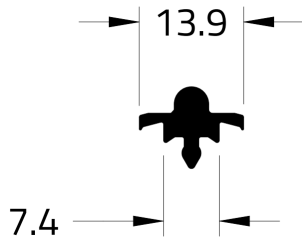

CHR-064
0,157 Kg/m

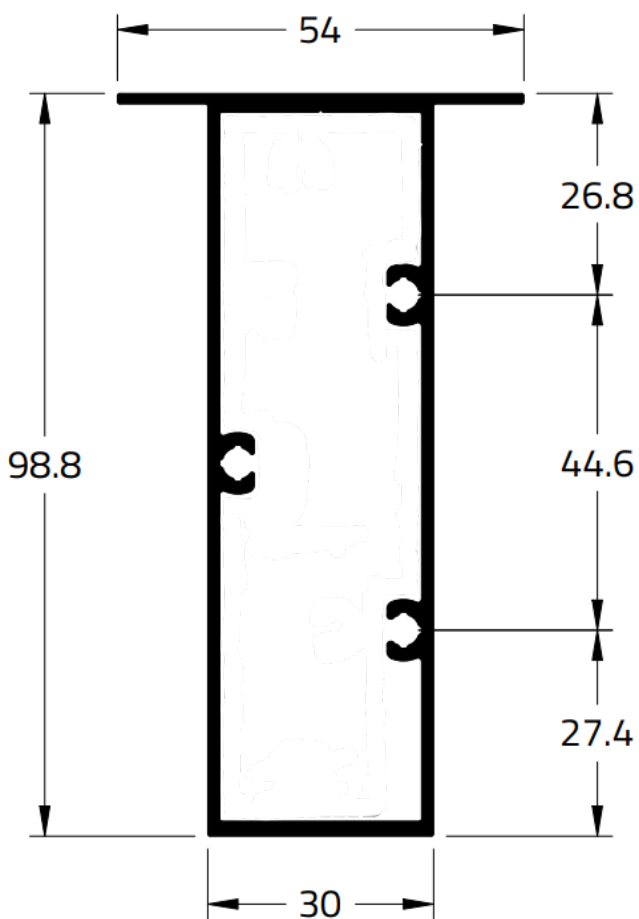

CHR-067
1,483 Kg/m

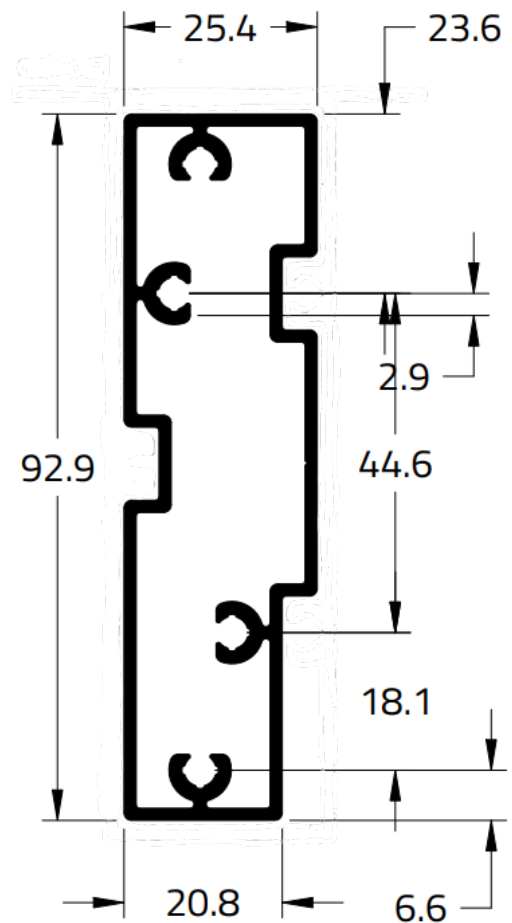

CHR-068
1,430 Kg/m

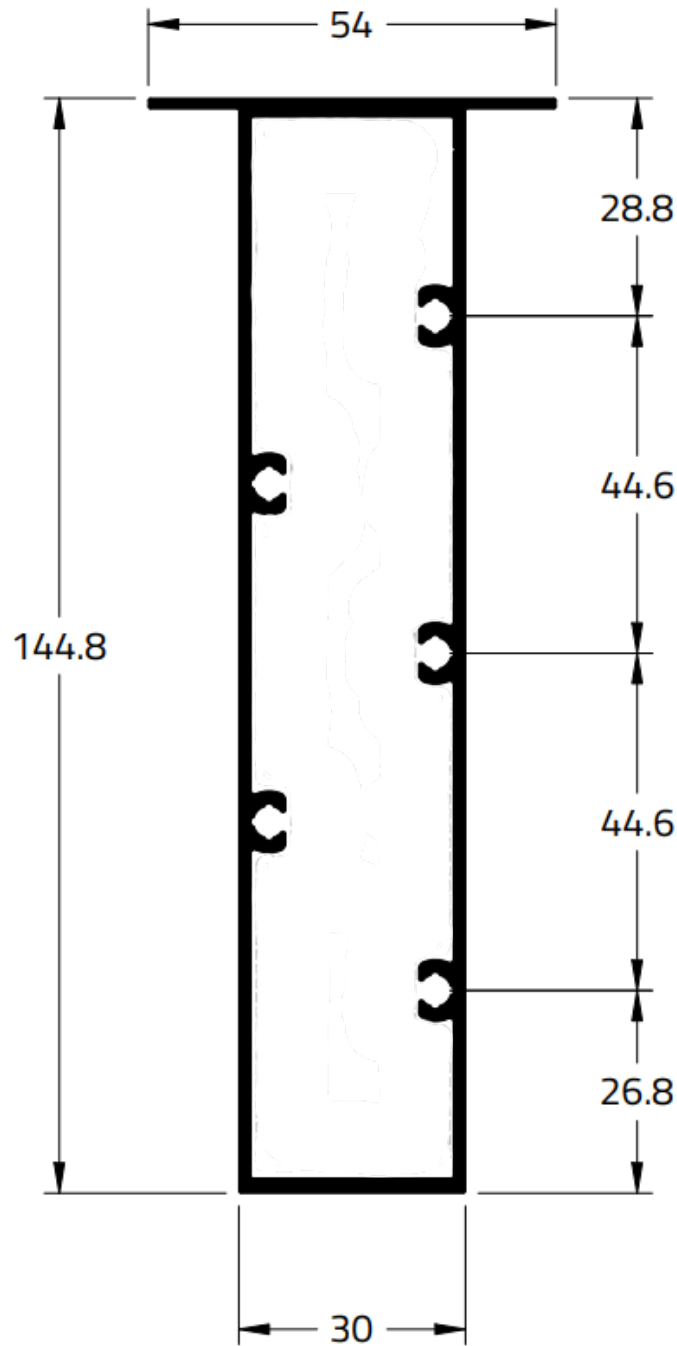

CHR-074
2,008 Kg/m



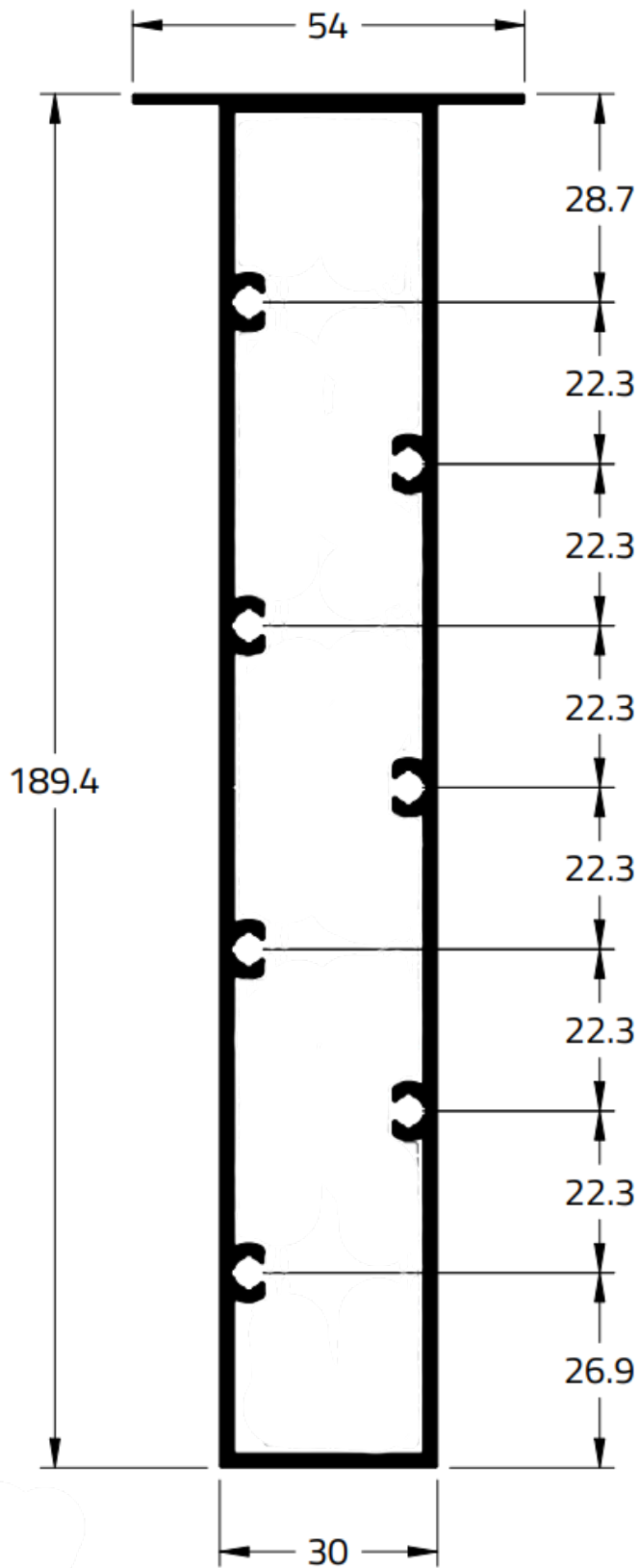

CHR-086
2,875 Kg/m

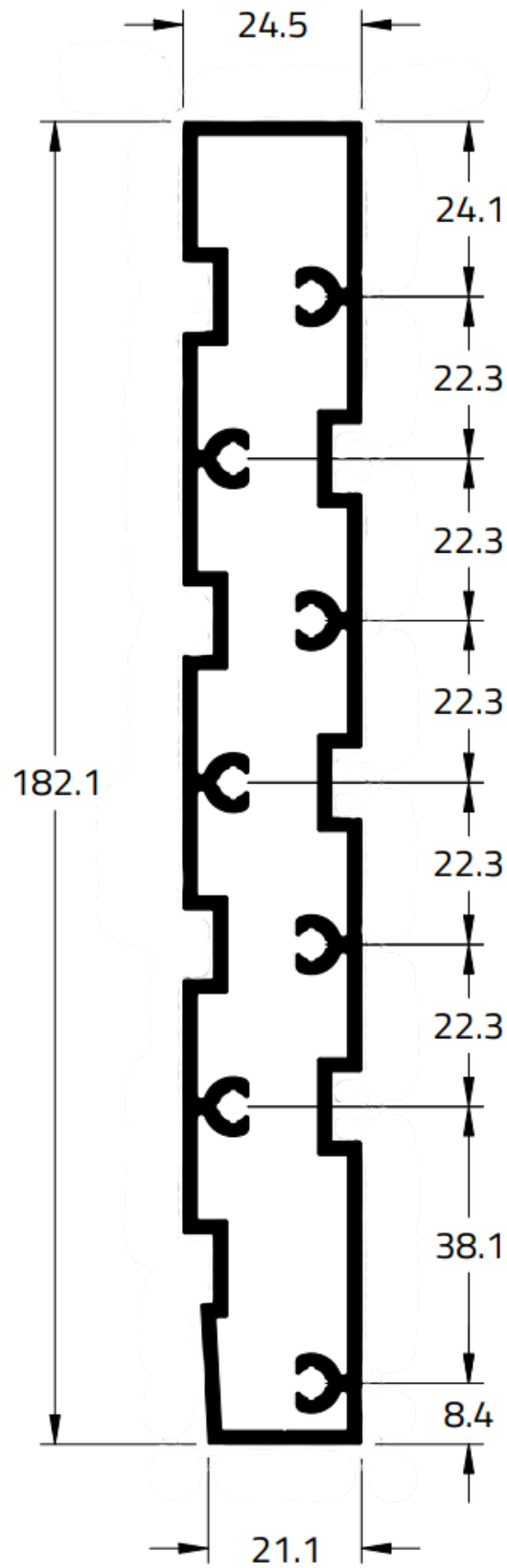

CHR-087
3,010 Kg/m





chroma

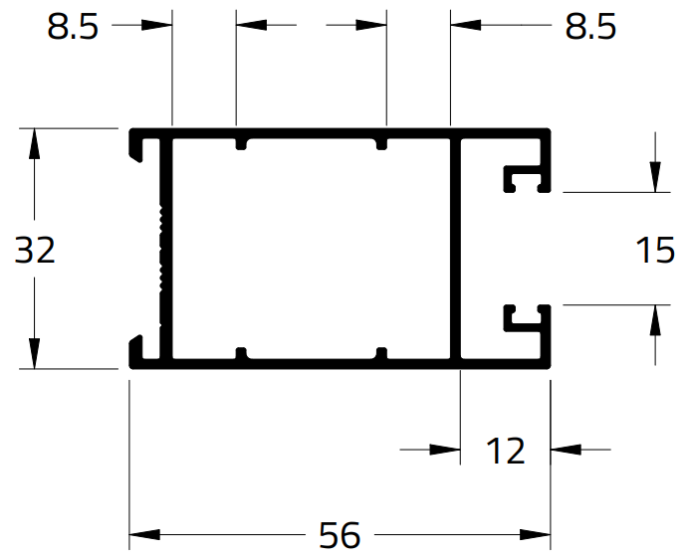

CHR-096
0,788 Kg/m

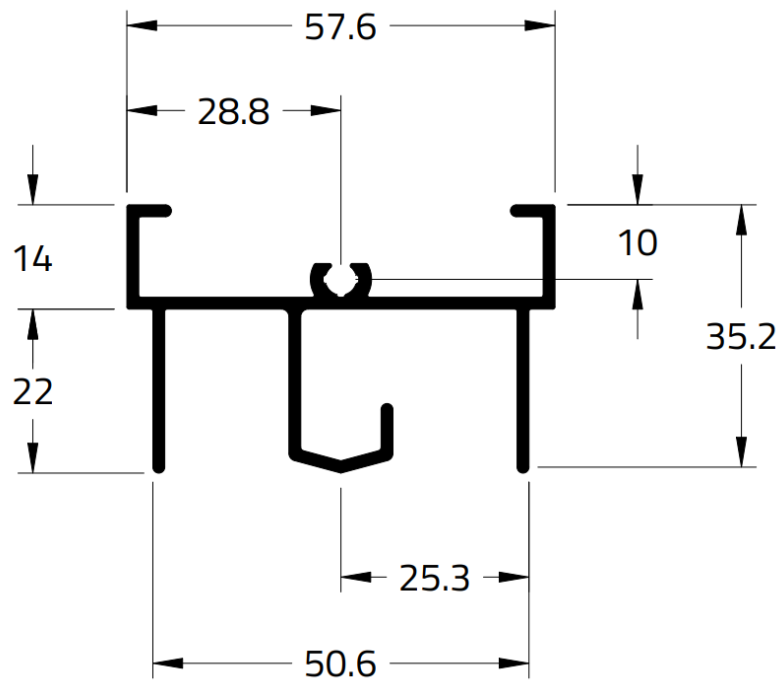

CHR-097
0,832 Kg/m





chroma

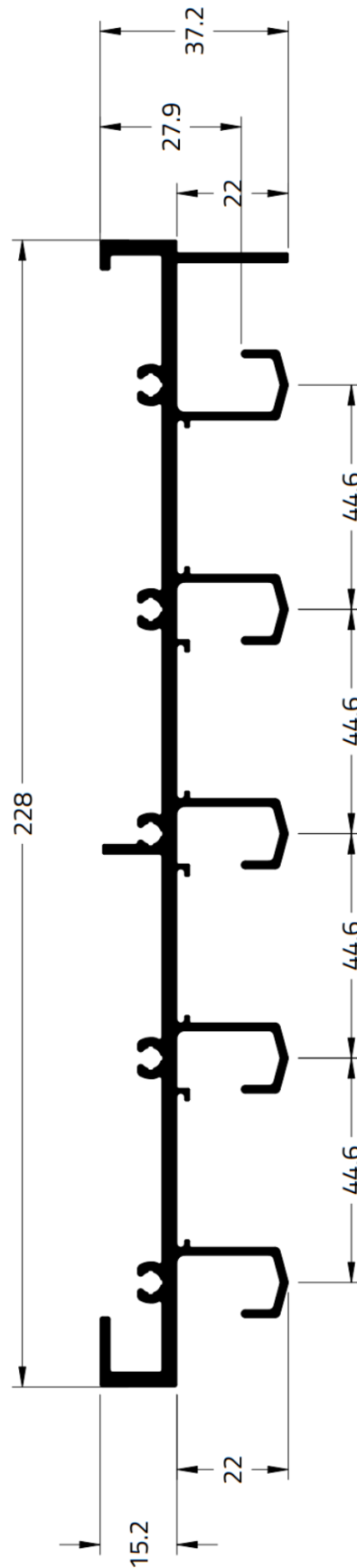

CHR-102
3,581 Kg/m



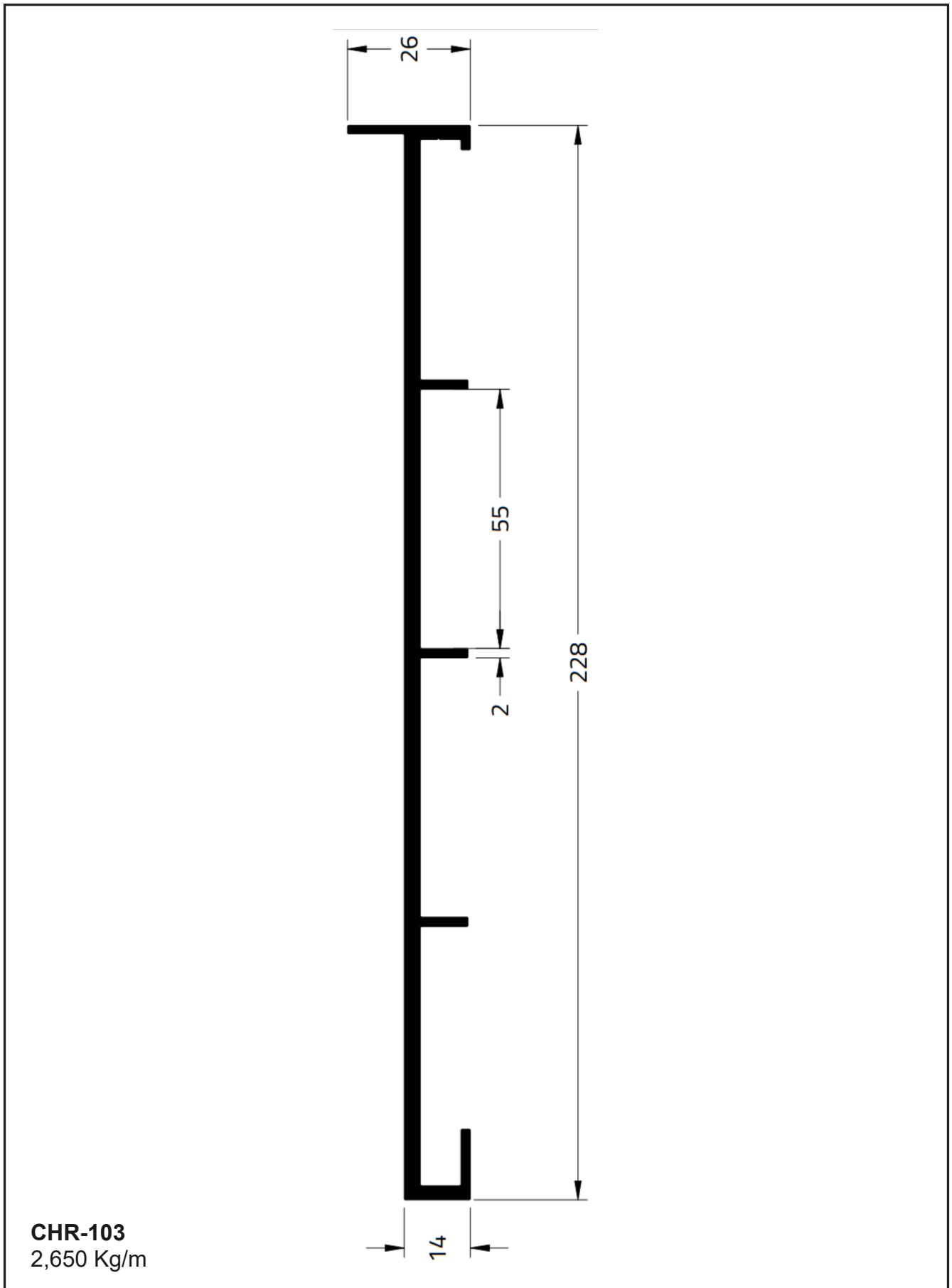

CHR-103
2,650 Kg/m



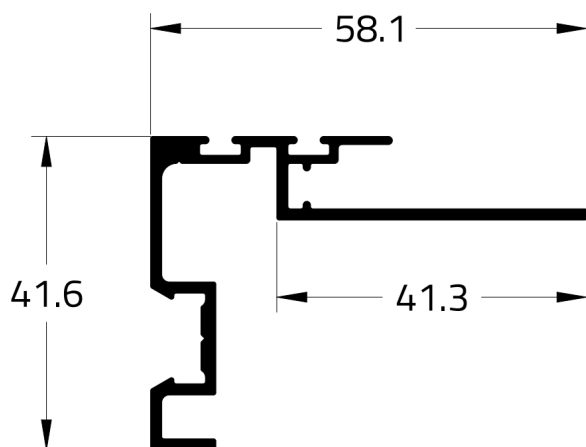

CHR-104
0,657 Kg/m

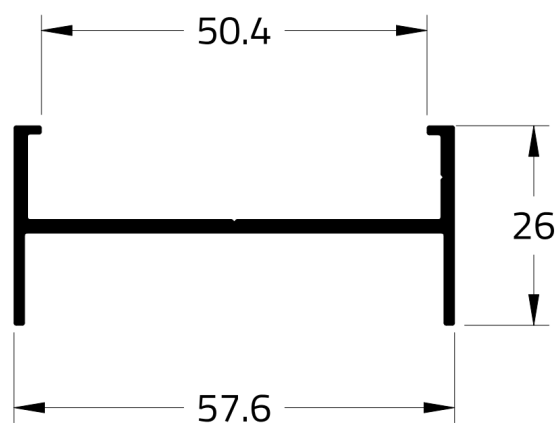

CHR-105
0,517 Kg/m

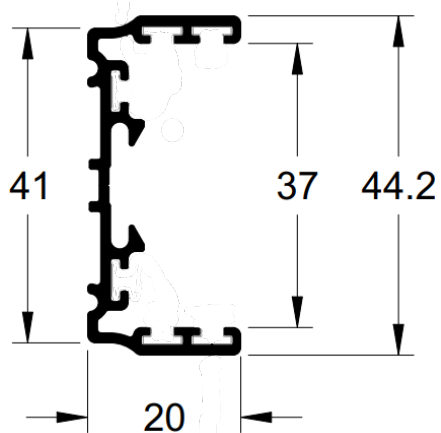

CHR-115
0,458 Kg/m

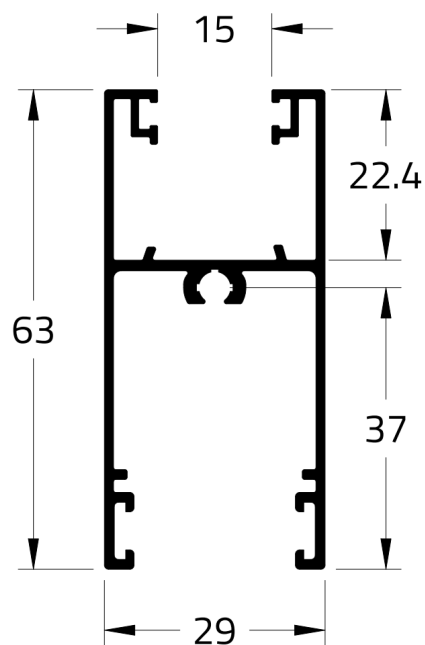

CHR-030
0,753 Kg/m

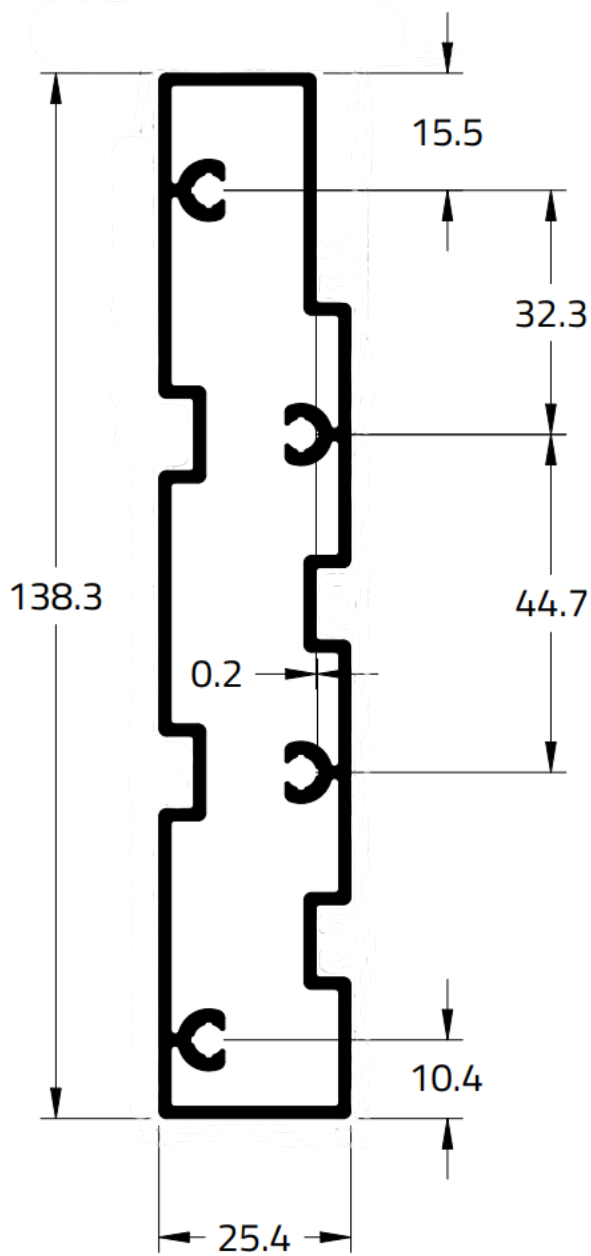

CHR-073
1,914 Kg/m

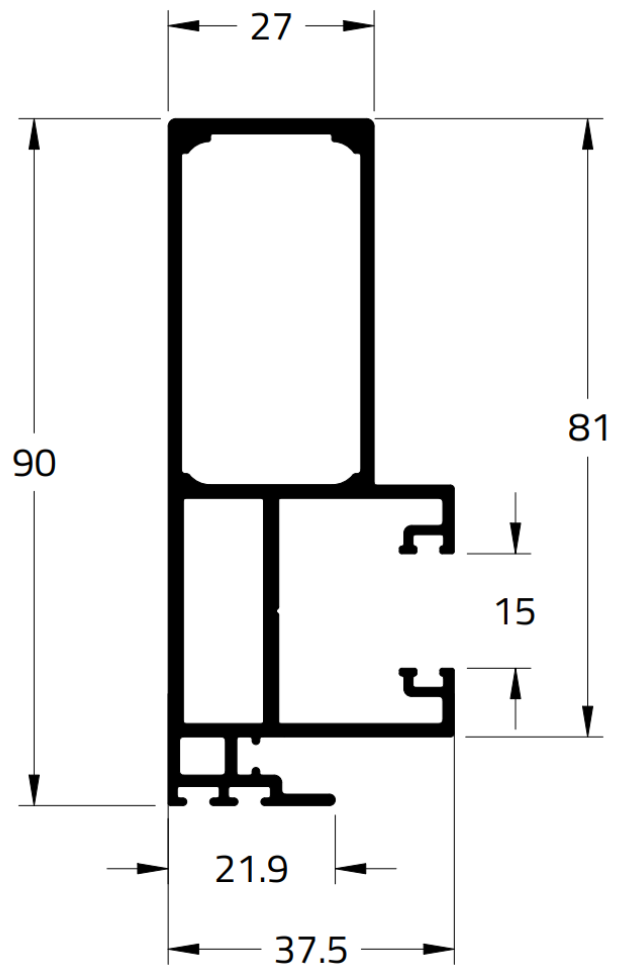

CHR-107
1,645 Kg/m



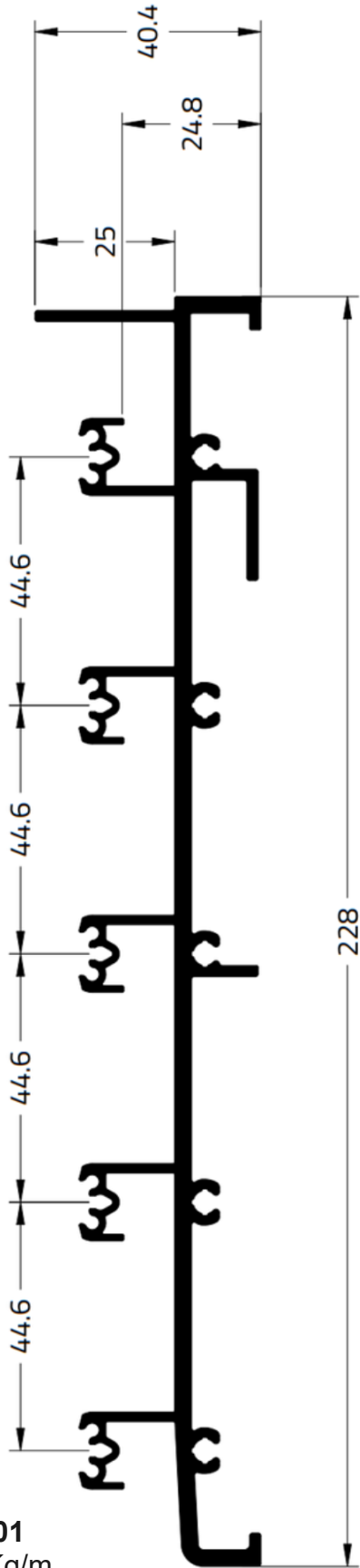

CHR-101
3,640 Kg/m

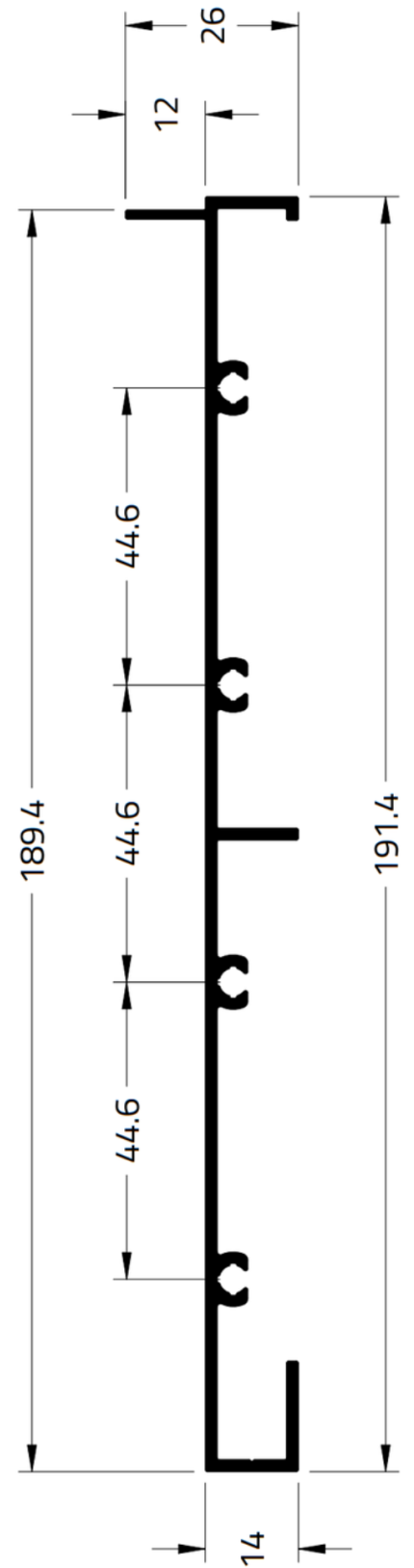

CHR-084
1,503 Kg/m



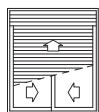

← MARCO SUPERIOR

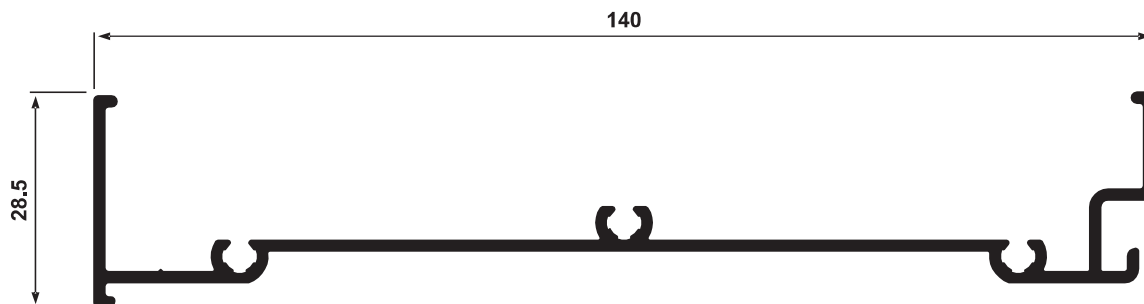

VNI-321
0,910 kg/m

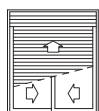

← MARCO INTERMEDIÁRIO

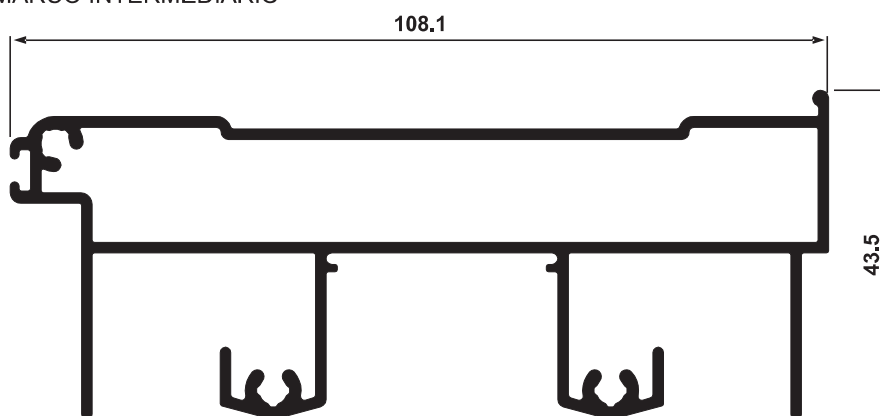

VNI-322
1,623 kg/m

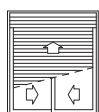

MARCO INFERIOR

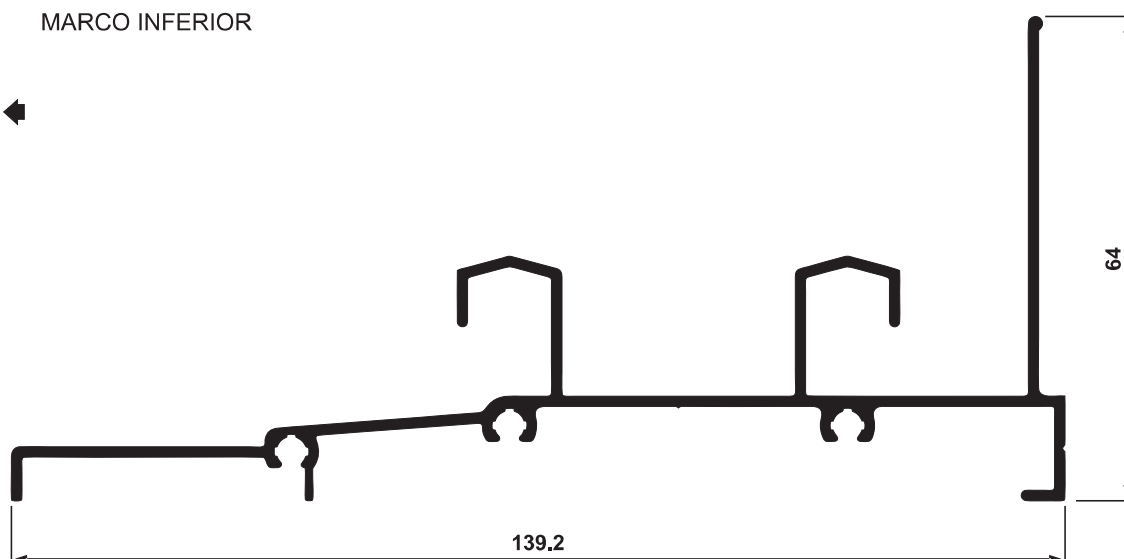

VNI-035
1,394 kg/m

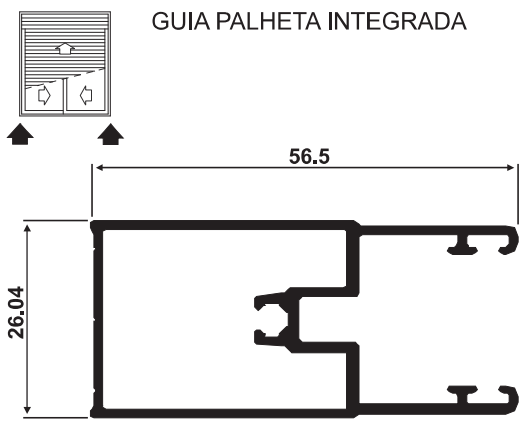
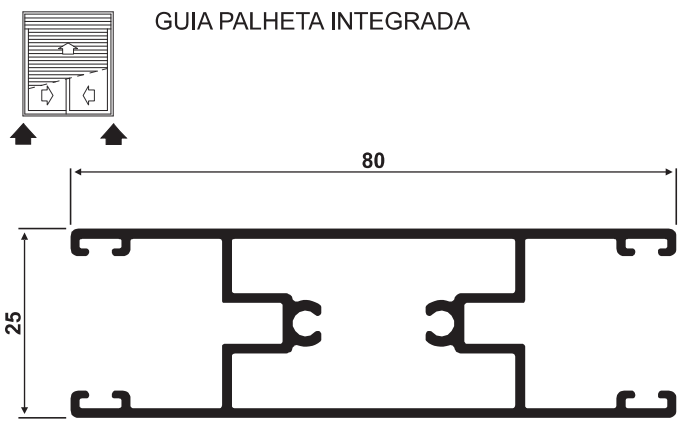
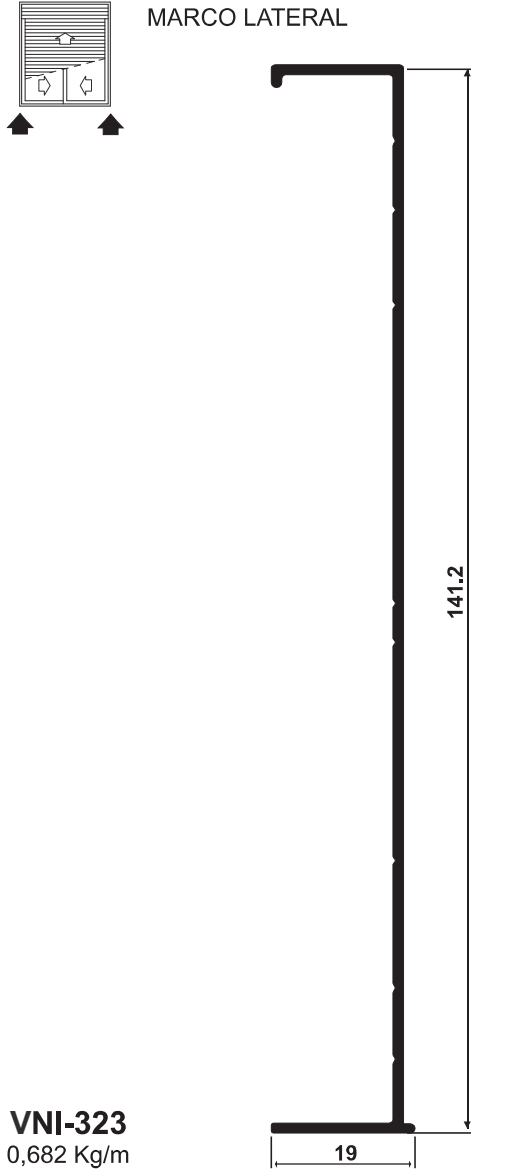
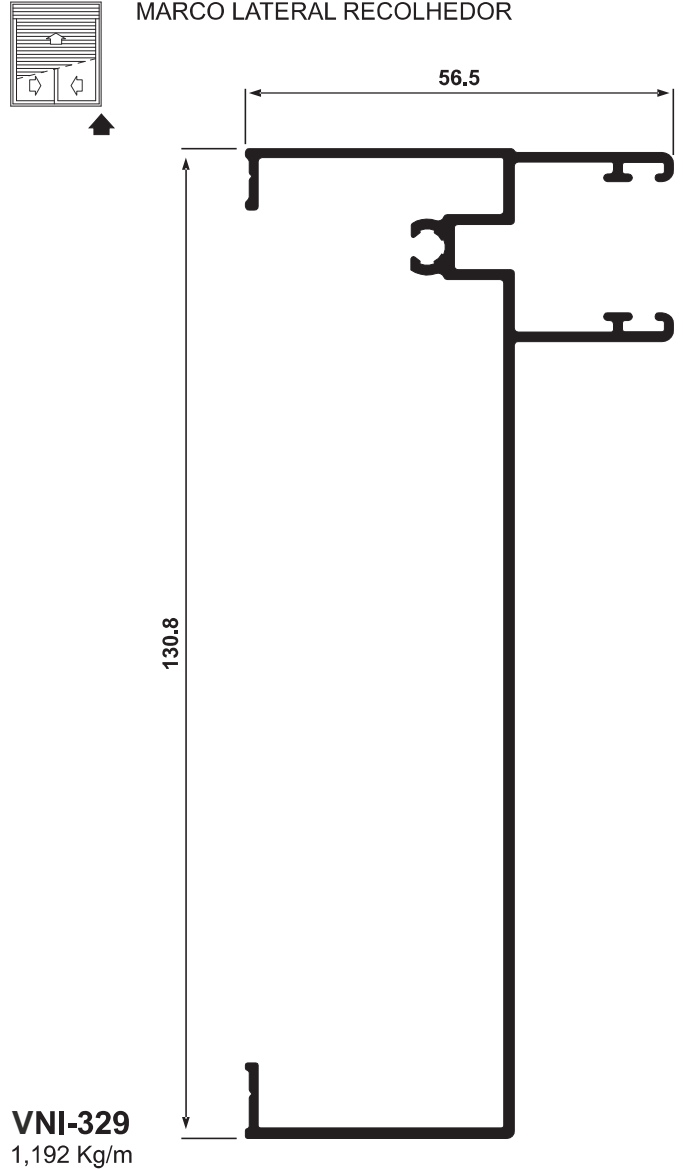

<p>GUIA PALHETA INTEGRADA</p>  <p>VNI-007 0,680 Kg/m</p>	<p>GUIA PALHETA INTEGRADA</p>  <p>VNI-027 0,983 Kg/m</p>
<p>MARCO LATERAL</p>  <p>VNI-323 0,682 Kg/m</p>	<p>MARCO LATERAL RECOLHEDOR</p>  <p>VNI-329 1,192 Kg/m</p>



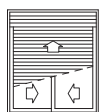

← MARCO SUPERIOR

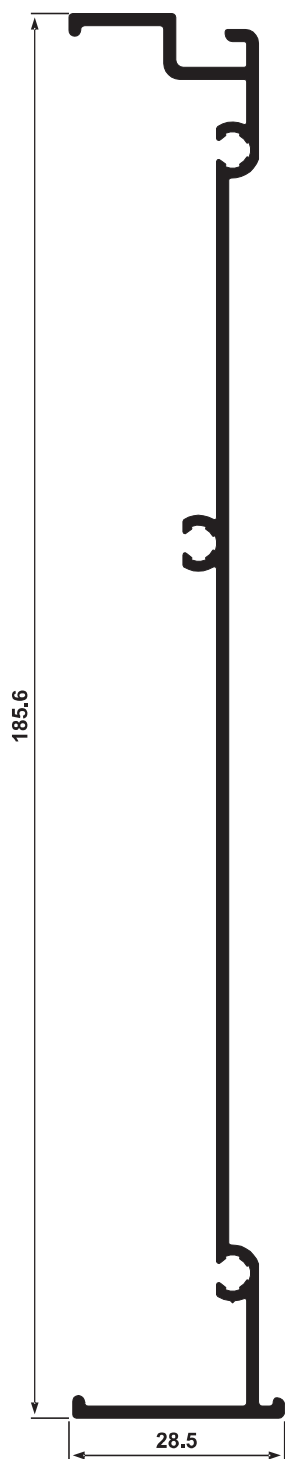

VNI-301
1,214 Kg/m

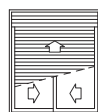

← MARCO INTERMEDIÁRIO

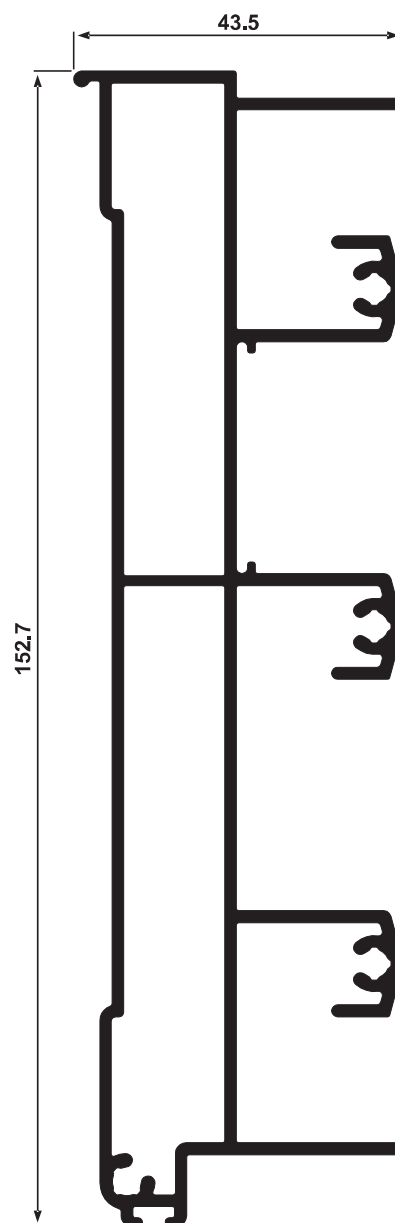

VNI-302
2,393 Kg/m



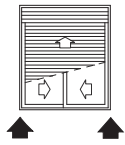

MARCO LATERAL

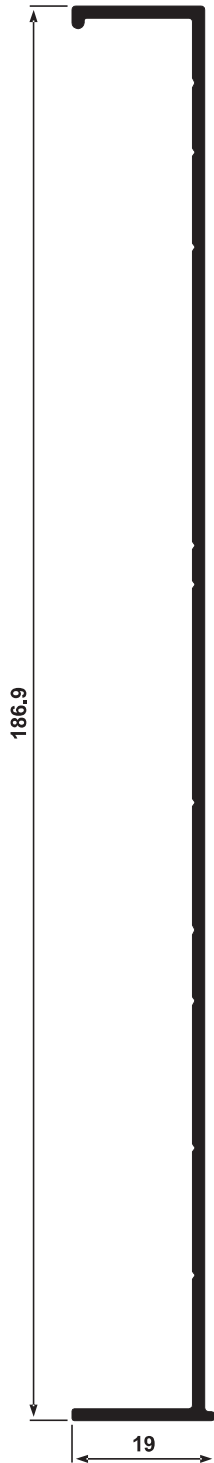

VNI-303
0,992 Kg/m

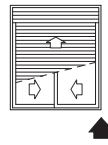

MARCO LATERAL RECOLHEDOR

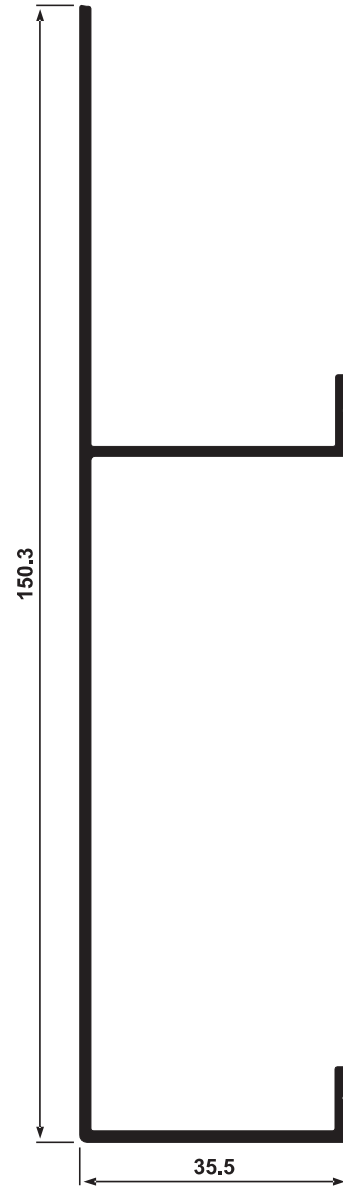

VNI-279
0,967 Kg/m



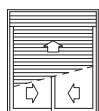

◀ TAMPA EXTERNA / JANELA

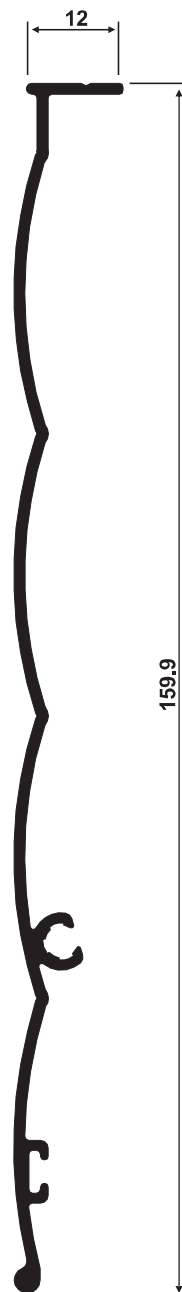

VNI-009
0,730 Kg/m

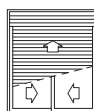

◀ TAMPA INTERNA / JANELA

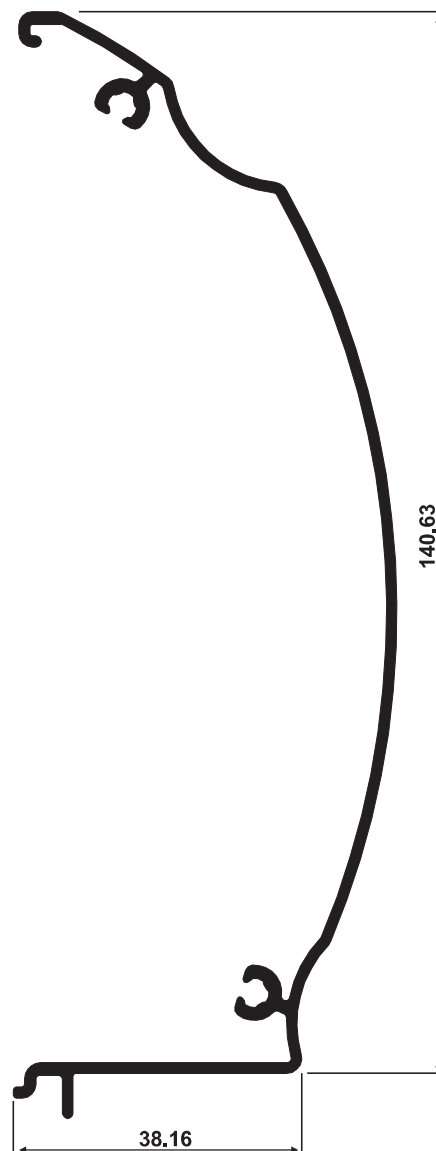

VNI-008
0,945 Kg/m



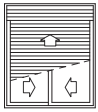

◀ TAMPA EXTERNA / PORTA

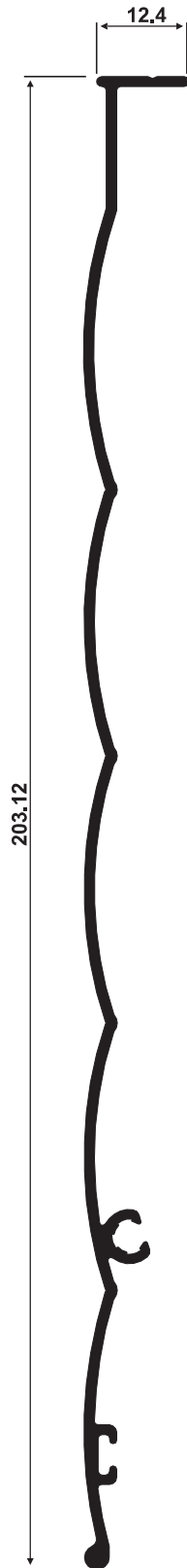

VNI-039
0,965 Kg/m

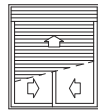

◀ TAMPA INTERNA / PORTA

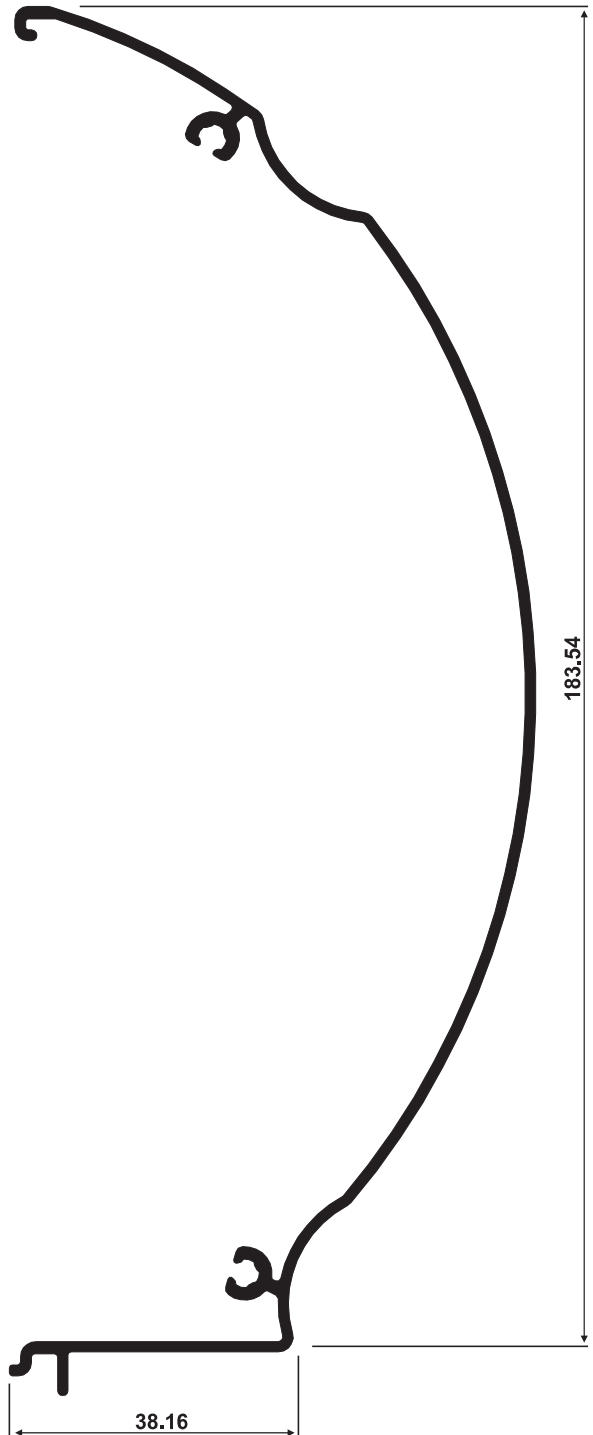

VNI-040
1,238 Kg/m



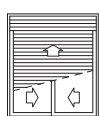

EIXO

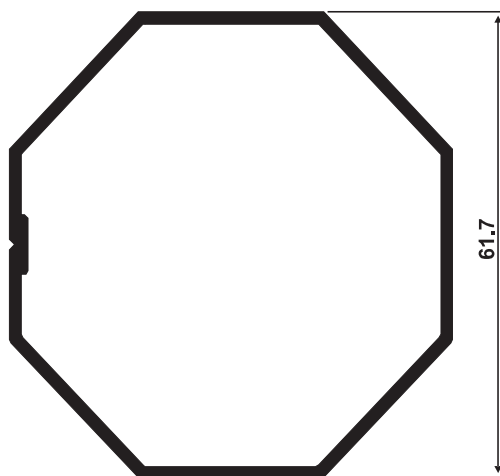

VNI-015
0,833 Kg/m

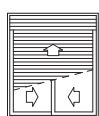

EIXO

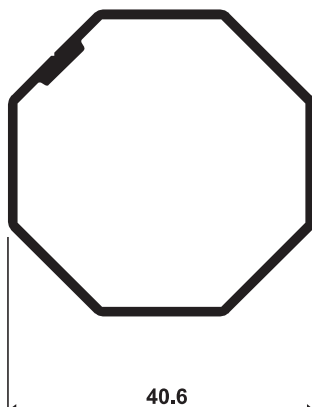

VNI-014
0,459 Kg/m

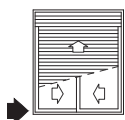





GUIA



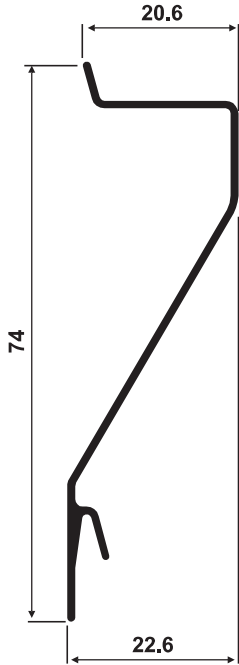
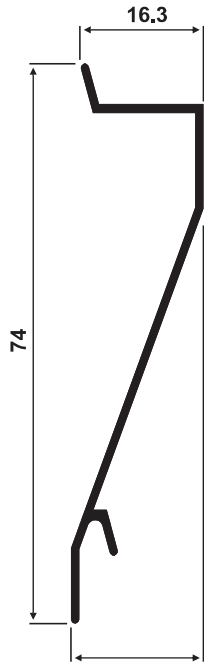

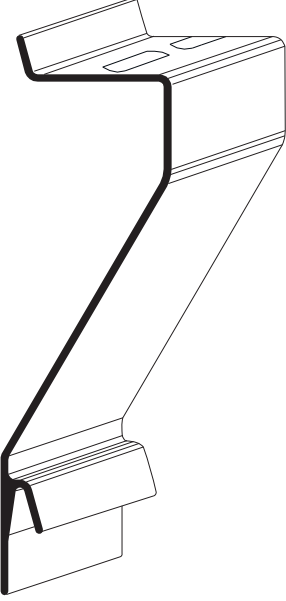
VNI-055
0,359 Kg/m



 <p>VZ-006 VZ-006 0,296 kg/m</p>	 <p>VZ-023 VZ-023 0,292 kg/m</p>	 <p>VZ-024 VZ-024 0,278 kg/m</p>	
 <p>US-285 US-285 0,296 kg/m</p>	 <p>US-282 US-282 0,292 kg/m</p>	 <p>US-280 US-280 0,278 kg/m</p>	

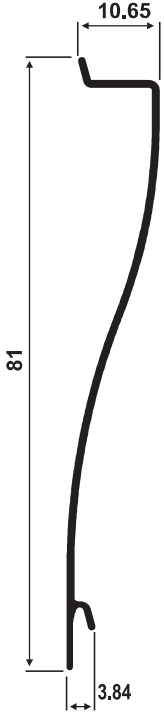
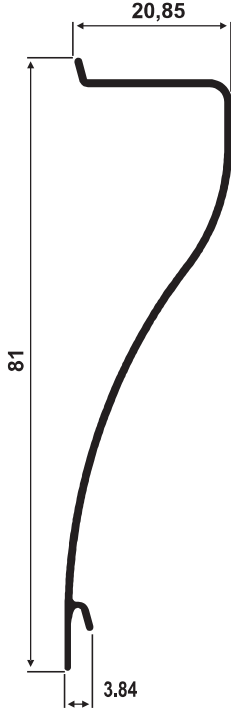
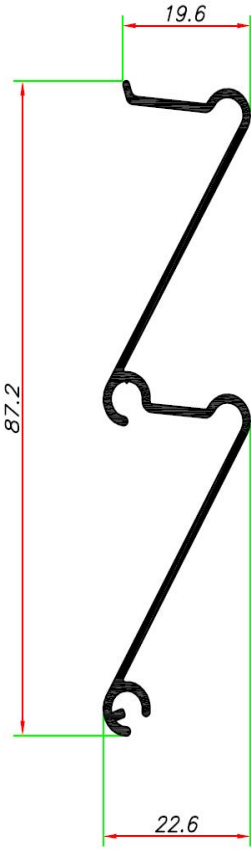

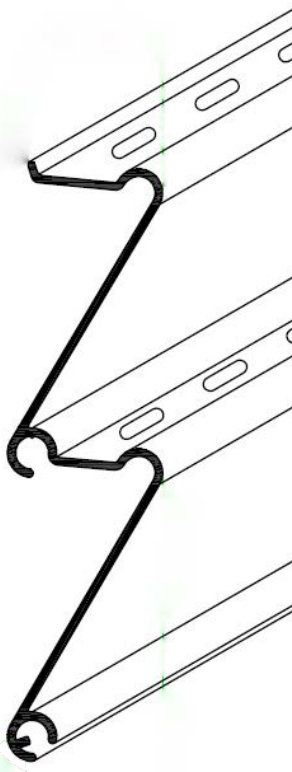
 <p>VZ-028 0,287 kg/m</p>	 <p>VZ-066 0,324 kg/m</p>	 <p>VZ-200 0,472kg/m</p>	
 <p>US-389 0,287 kg/m</p>	 <p>US-385 0,324 kg/m</p>	 <p>US-300 0,472kg/m</p>	



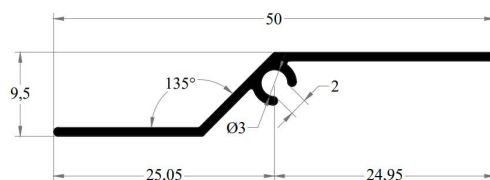

VZ-025
0,164 kg/mt

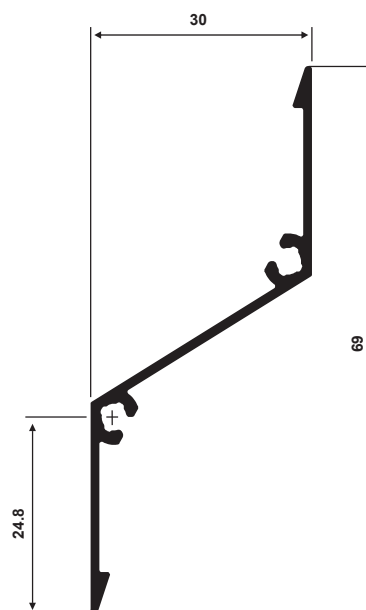

VZ-026
0,376 kg/mt

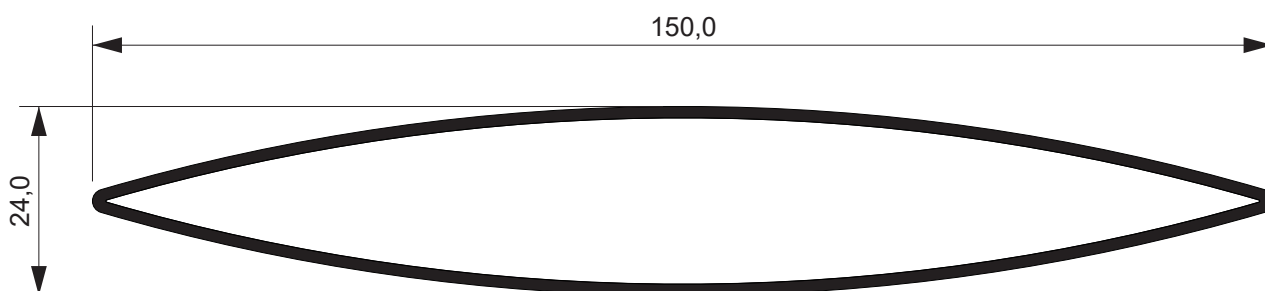

DC-004
1,190 kg/mt

FACHADA ATHEX

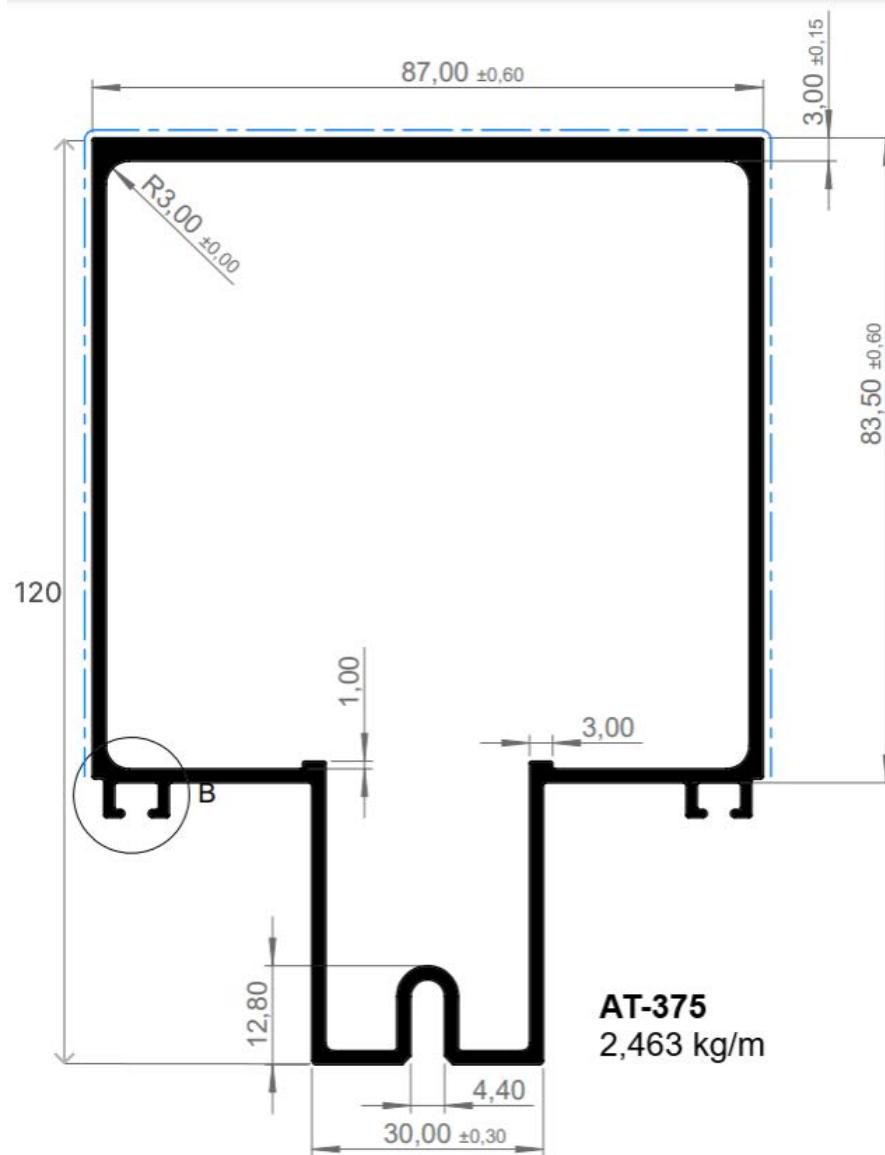

AT-375 - 2,463 kg/mt
Coluna Central



FACHADA ATHEX

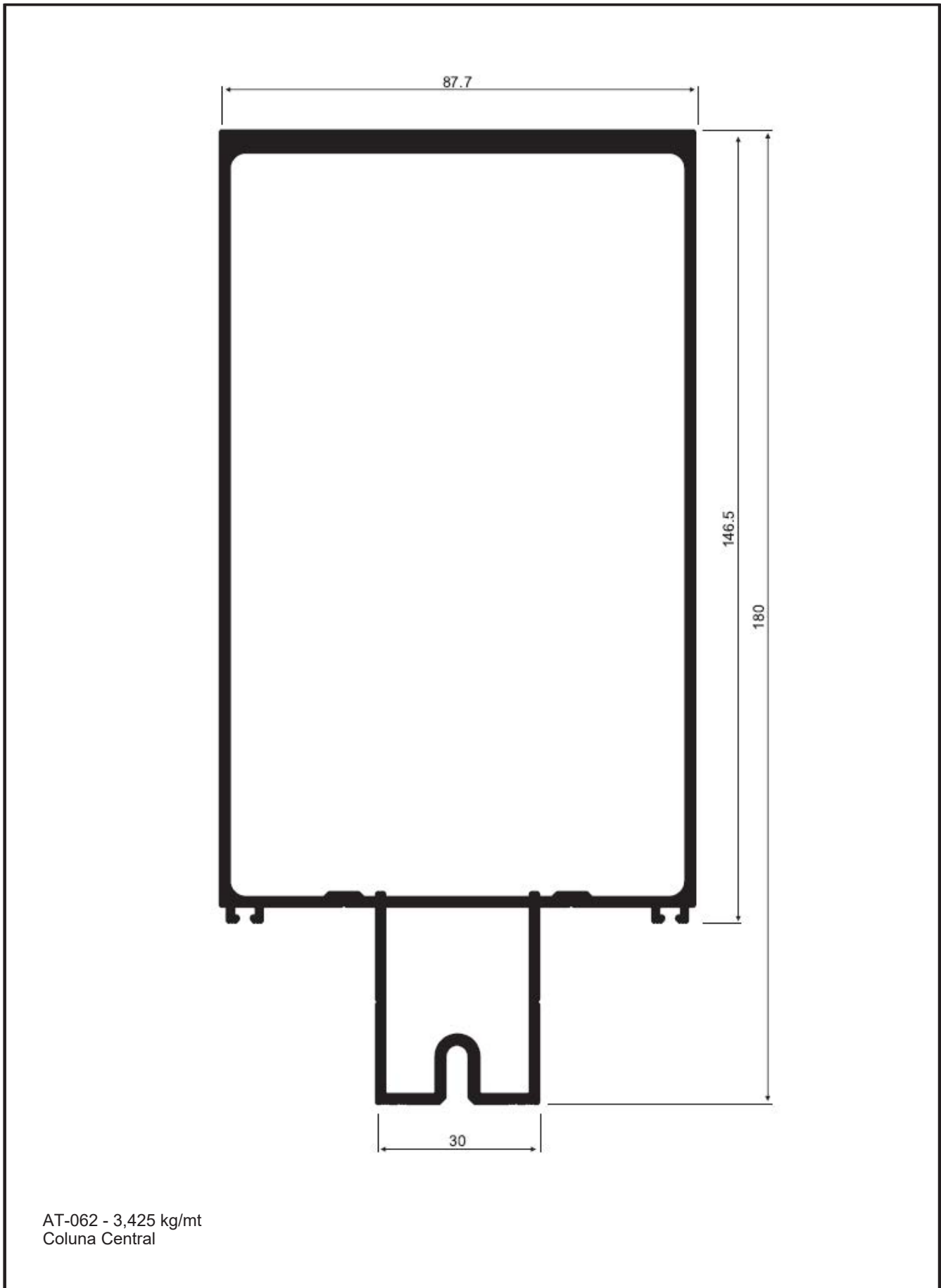

AT-062 - 3,425 kg/mt
Coluna Central



FACHADA ATHEX

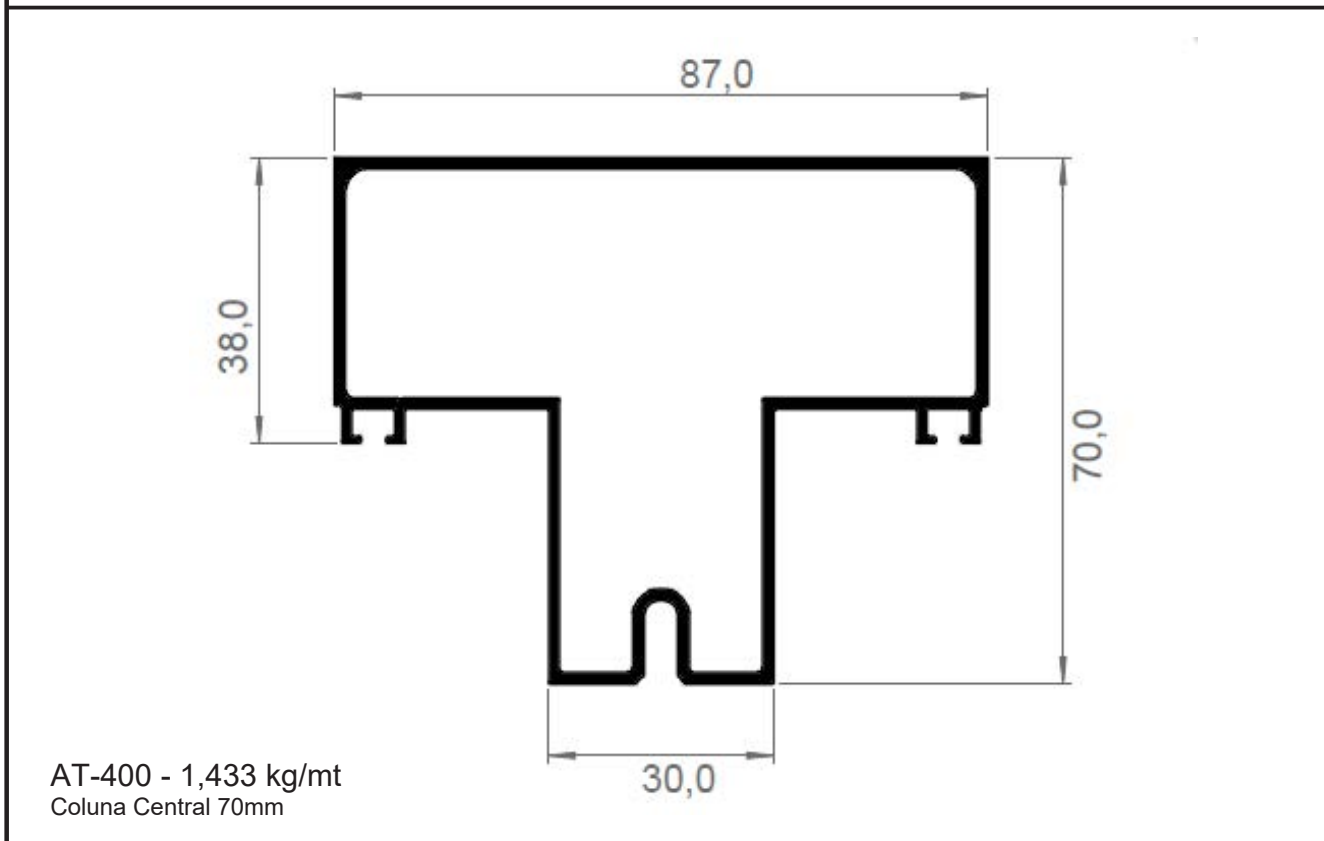
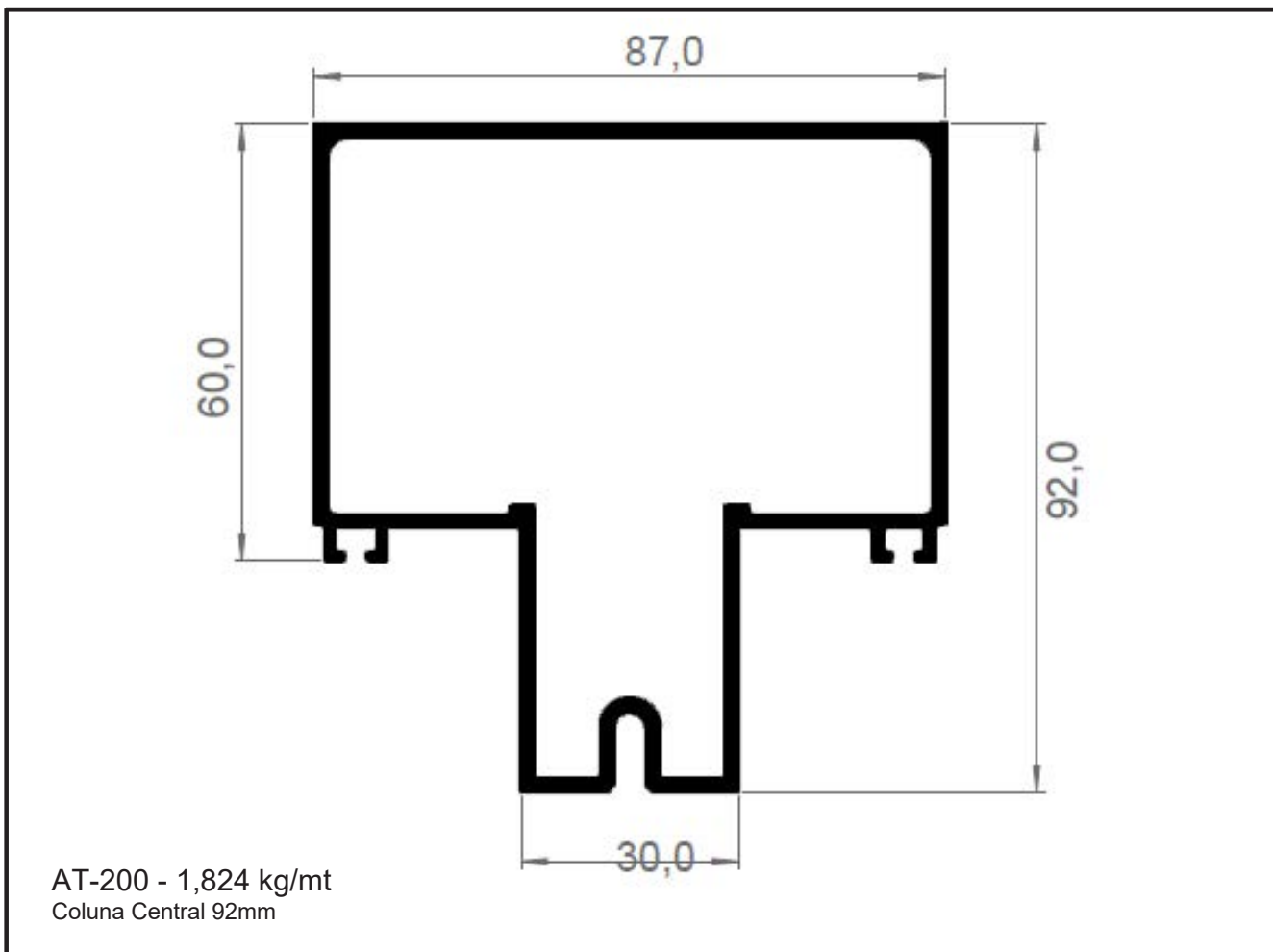

FACHADA ATHEX

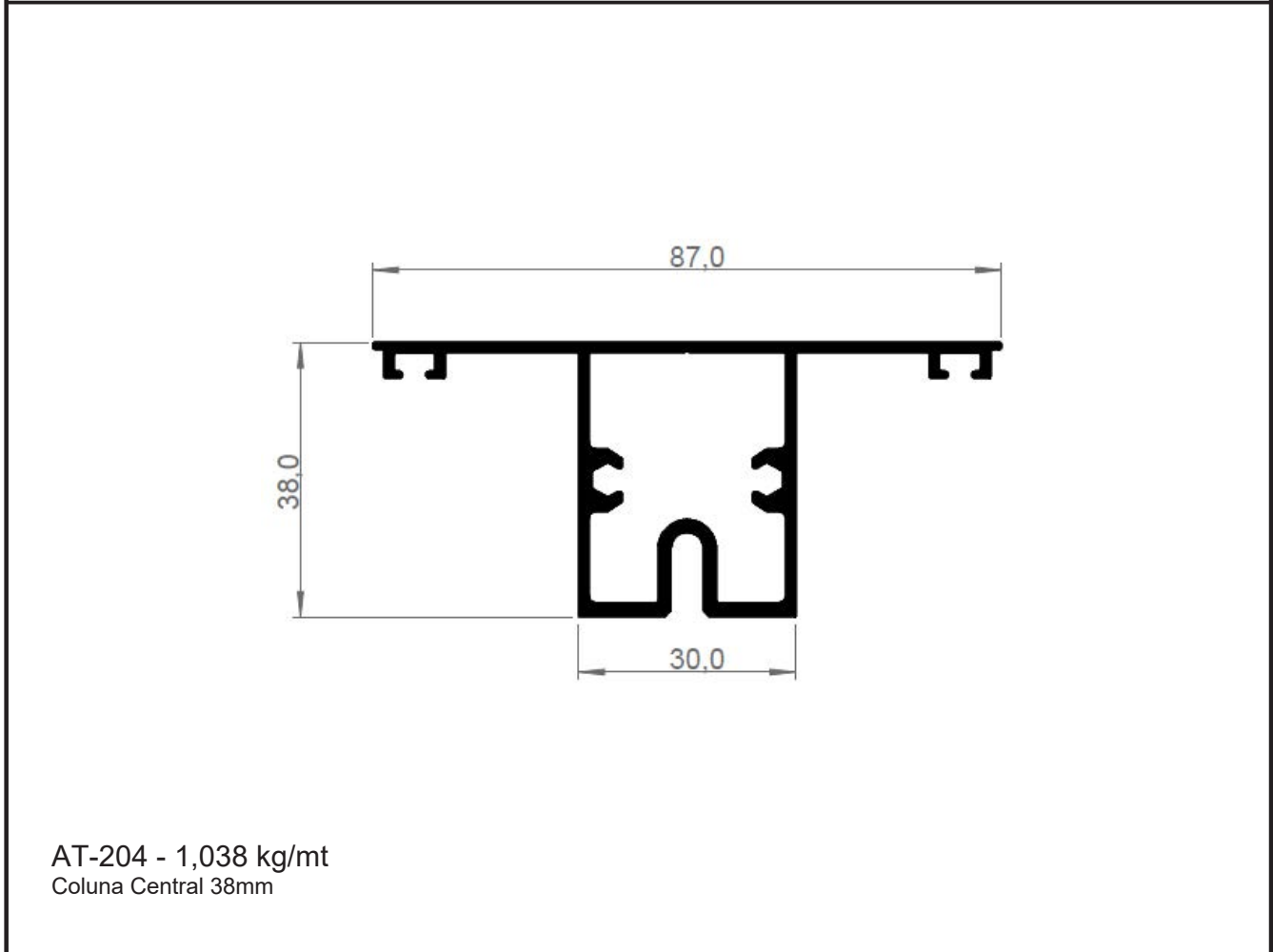
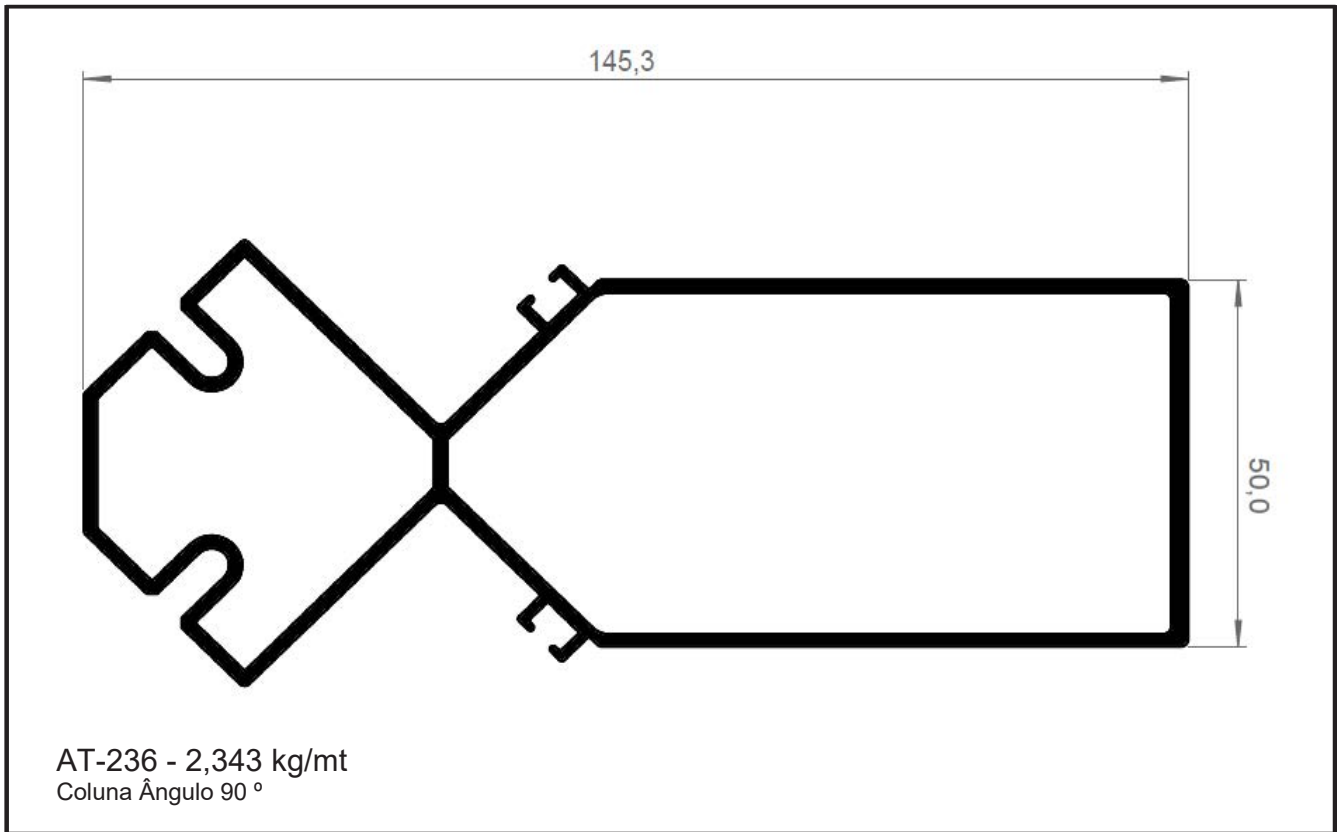

FACHADA ATHEX

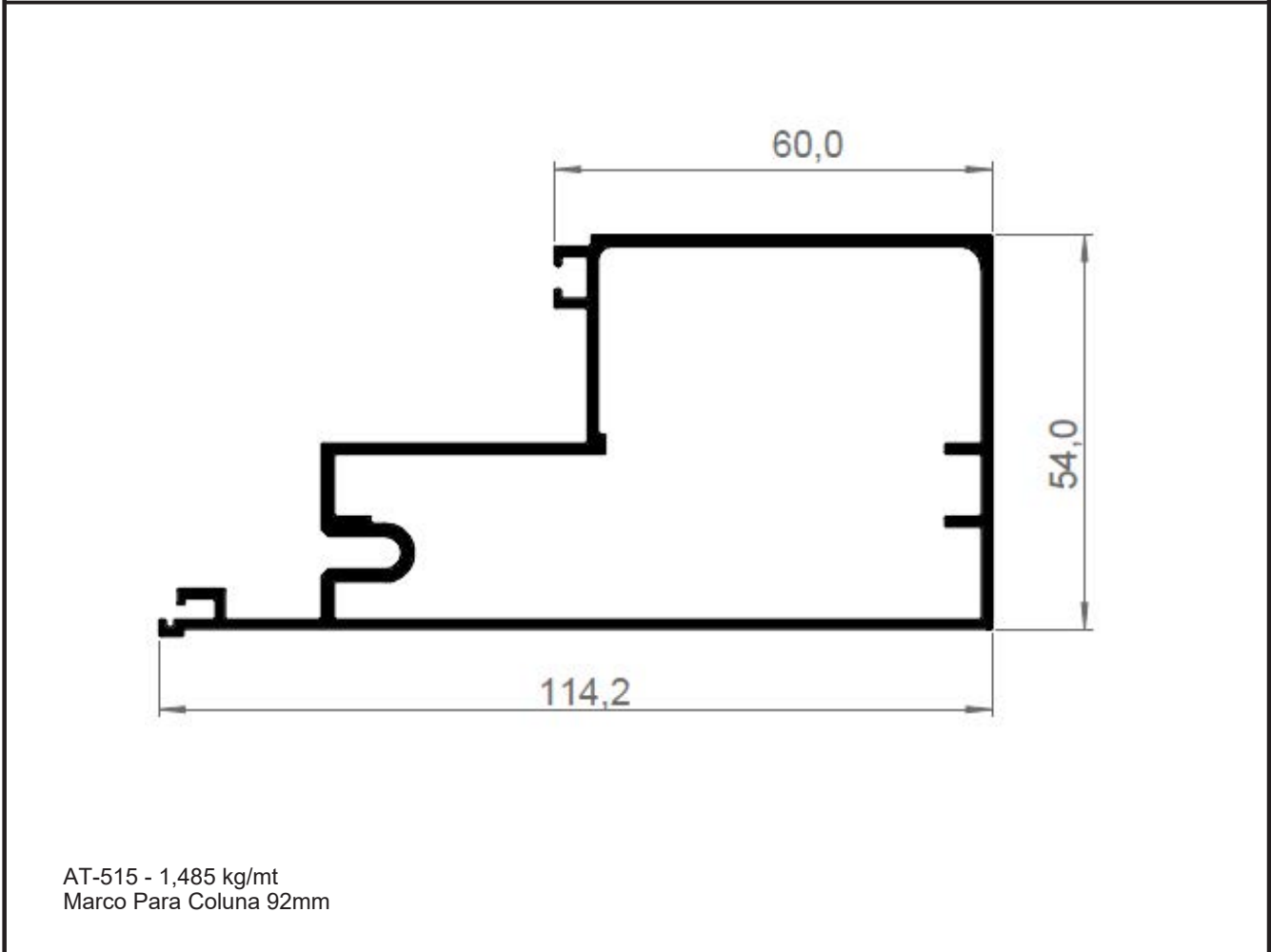
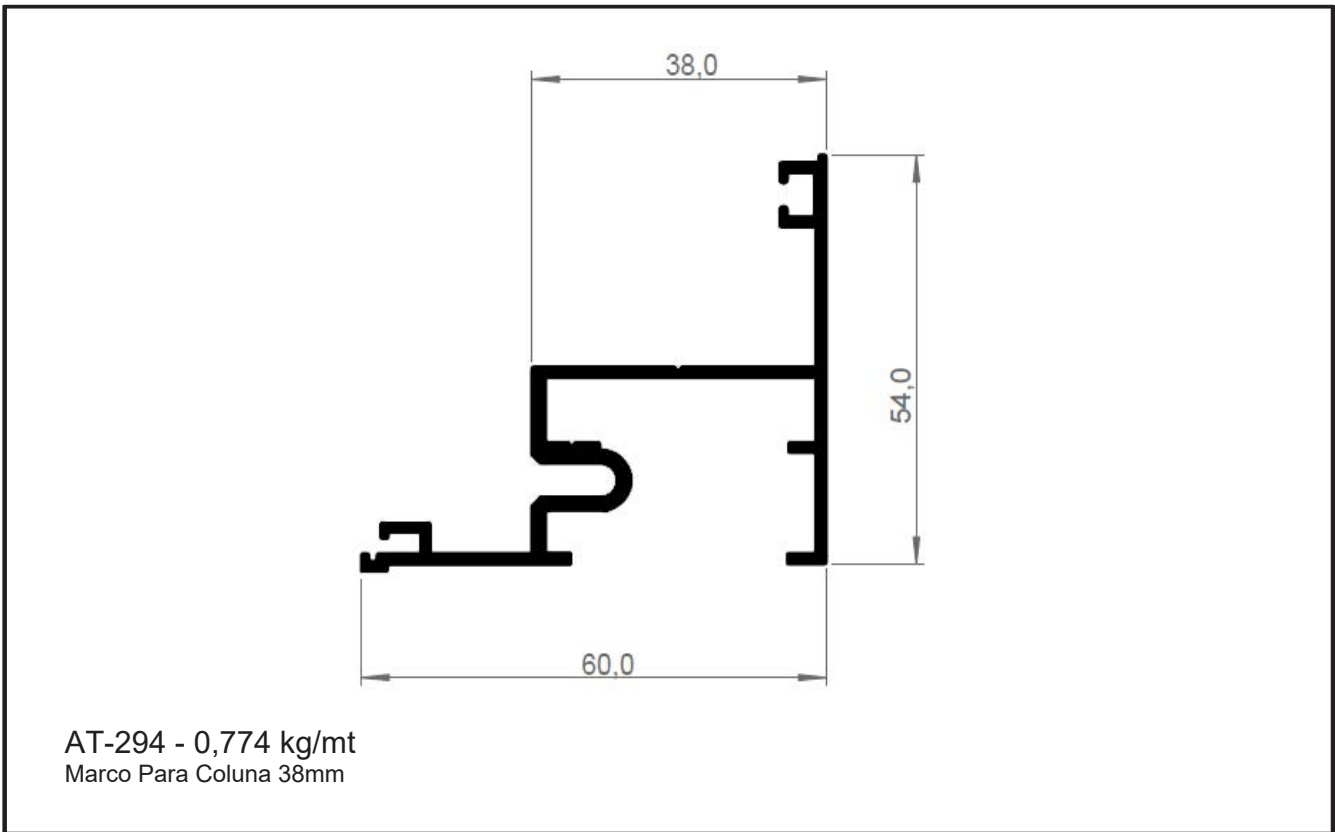

FACHADA ATHEX

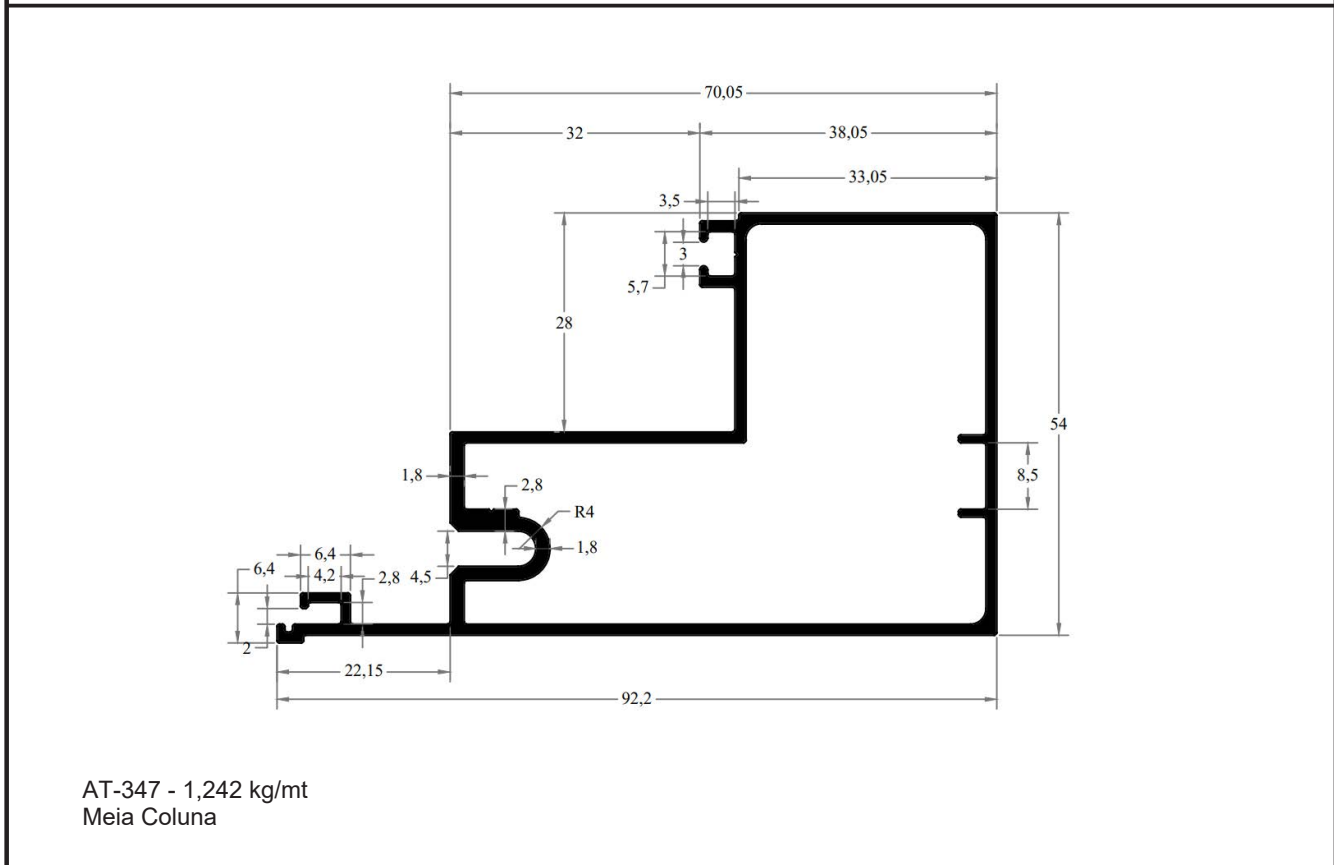
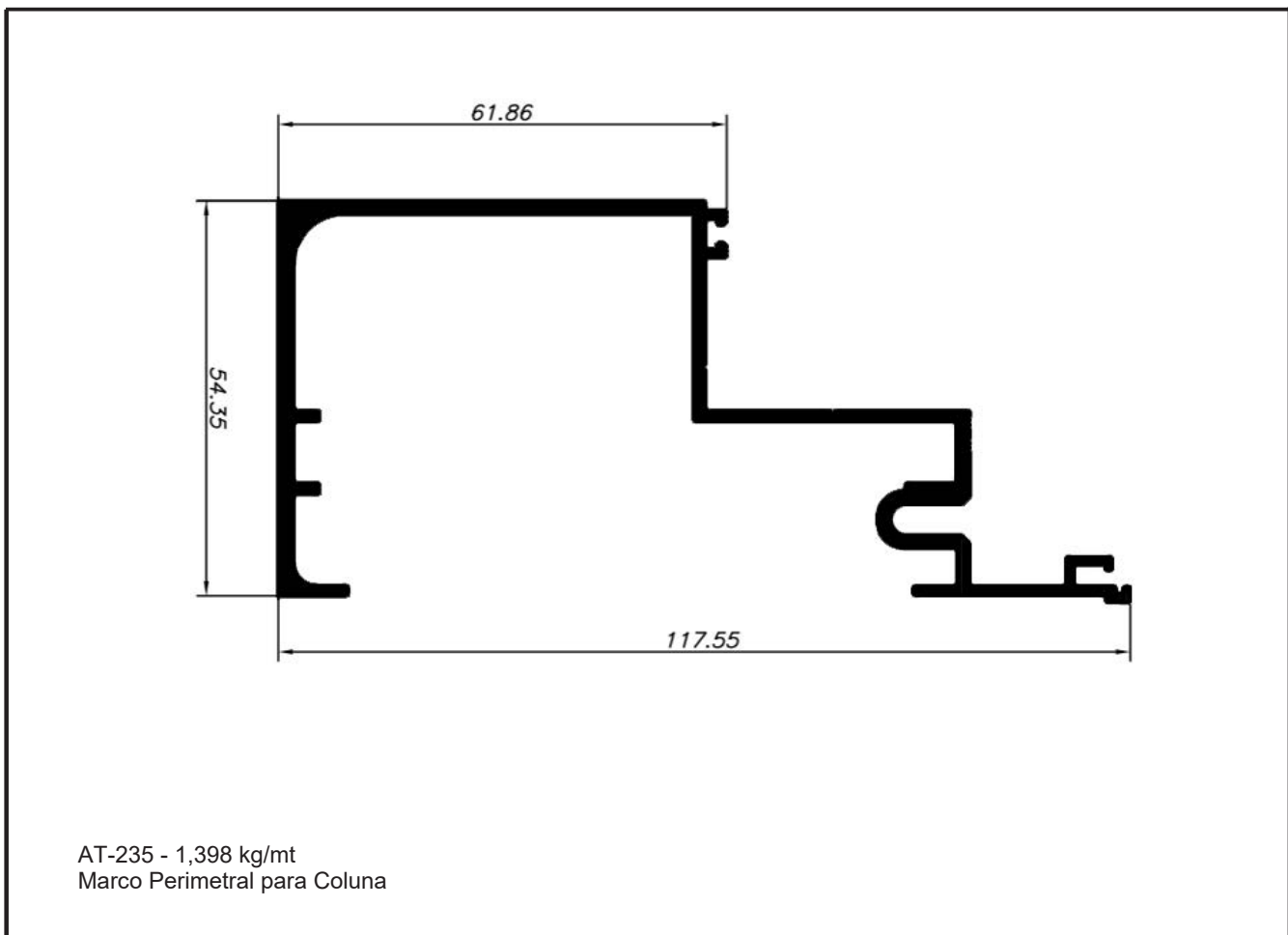

FACHADA ATHEX

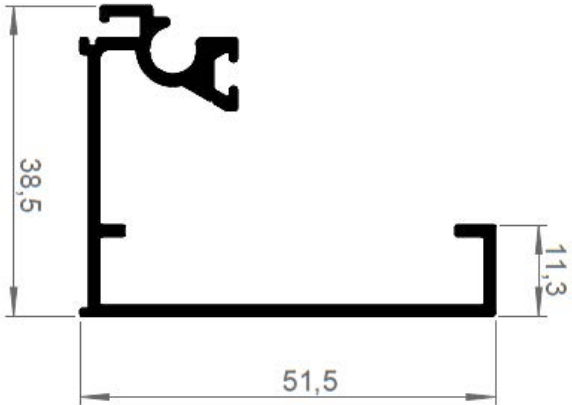
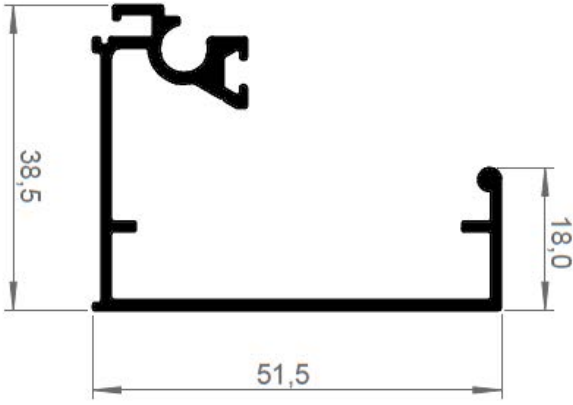
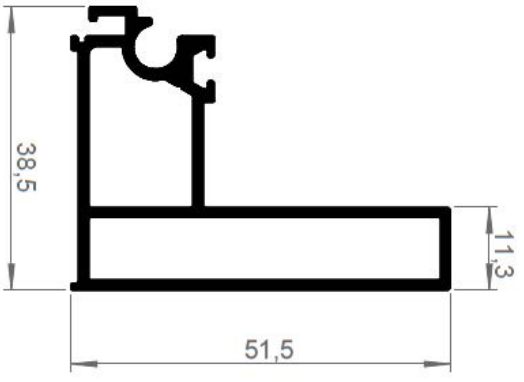
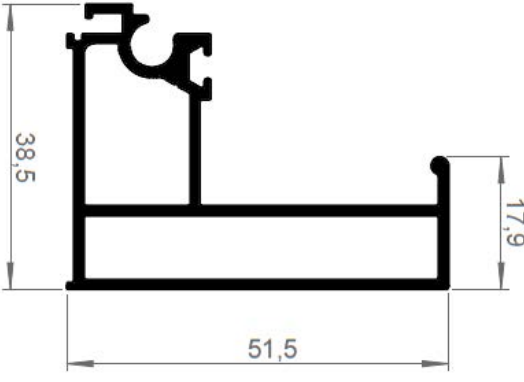
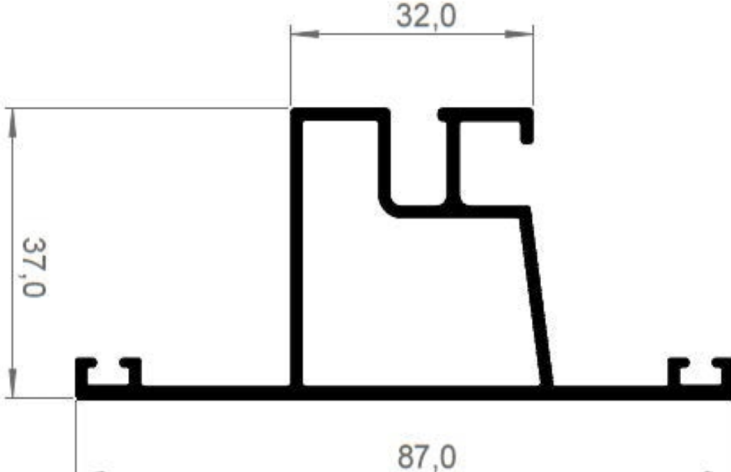

 <p>AT-228 - 0,572 kg/mt Folha Fixa</p>	 <p>AT-232 - 0,607 kg/mt Folha Fixa</p>
 <p>AT-245 - 0,784 kg/mt Folha Móvel</p>	 <p>AT-230 - 0,813 kg/mt Folha Móvel</p>
 <p>AT-233 - 0,886 kg/mt Travessa Horizontal</p>	



FACHADA ATHEX

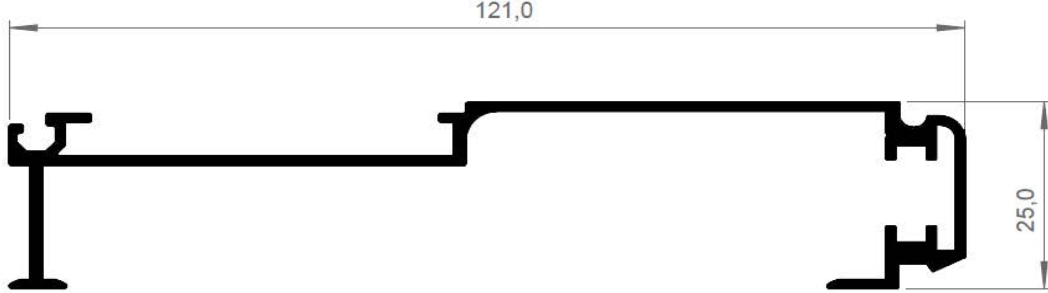
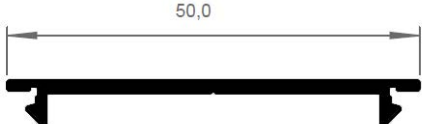
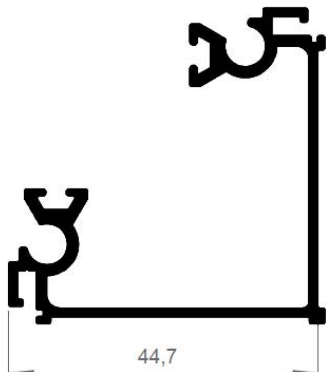
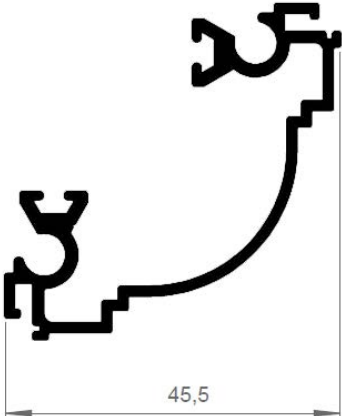
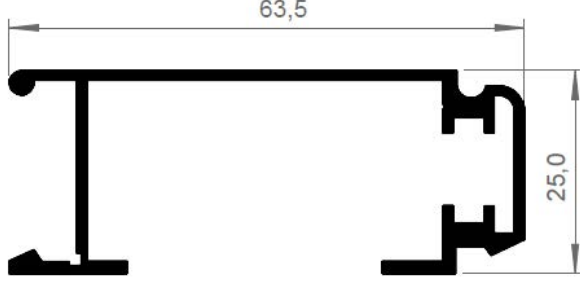
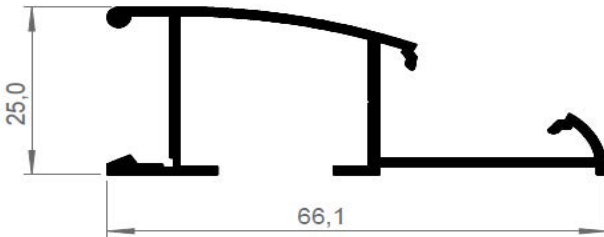
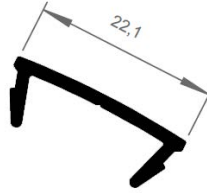

 <p>AT-265 - 0,802 kg/mt Complemento Arremate</p>	
 <p>AT-299 - 0,224 kg/mt Clique Complemento Arremate</p>	 <p>AT-269 - 0,623 kg/mt Acabamento 90°</p>
 <p>AT-273 - 0,590 kg/mt Acabamento 90°</p>	 <p>AT-239 - 0,587 kg/mt Complemento Arremate</p>
 <p>AT-238 - 0,519 kg/mt Arremate Teto/Piso</p>	 <p>AT-237 - 0,116 kg/mt Clique do Arremate</p>



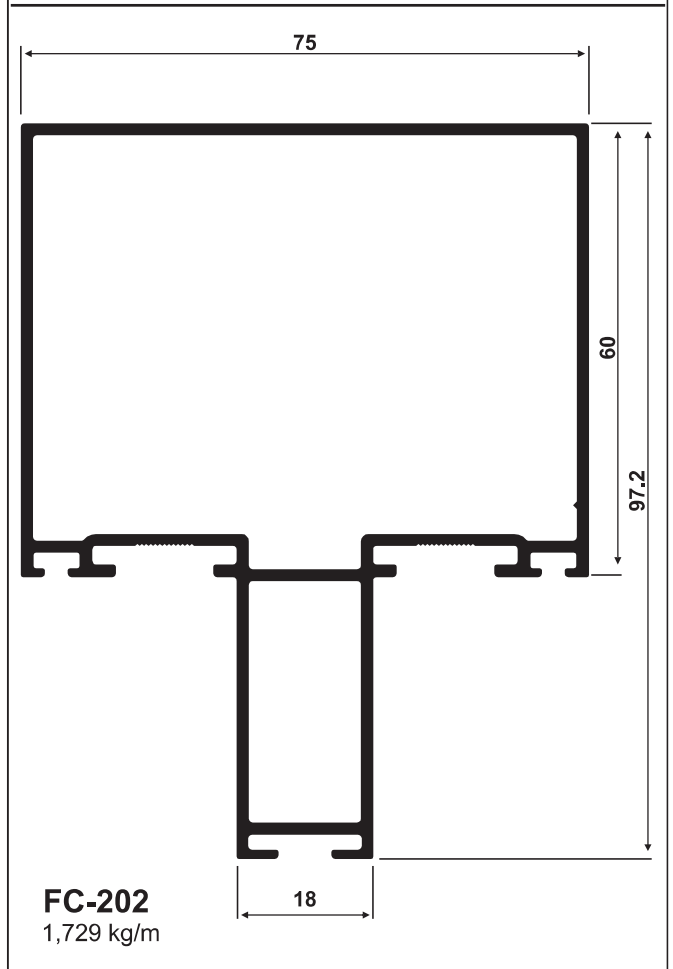
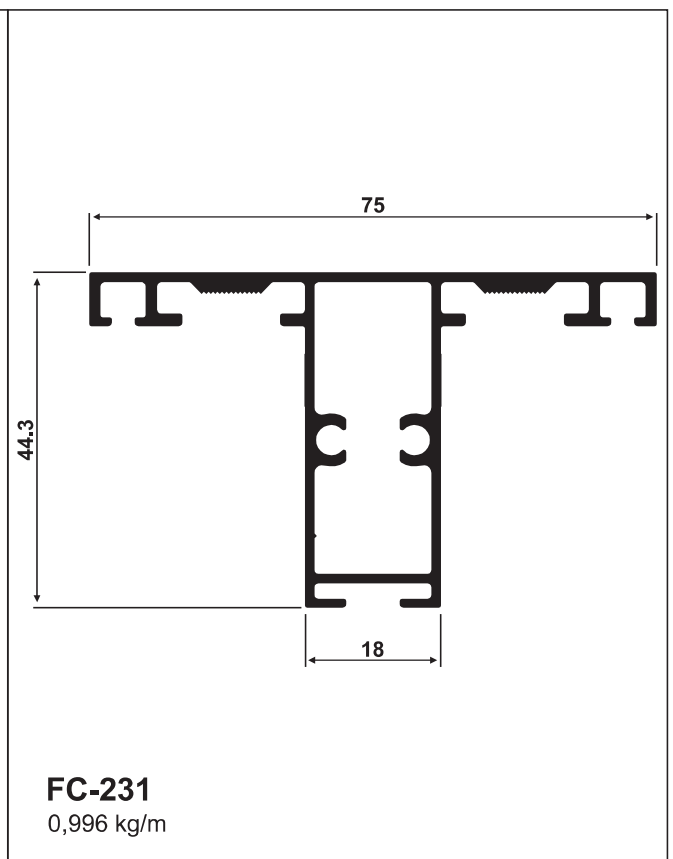
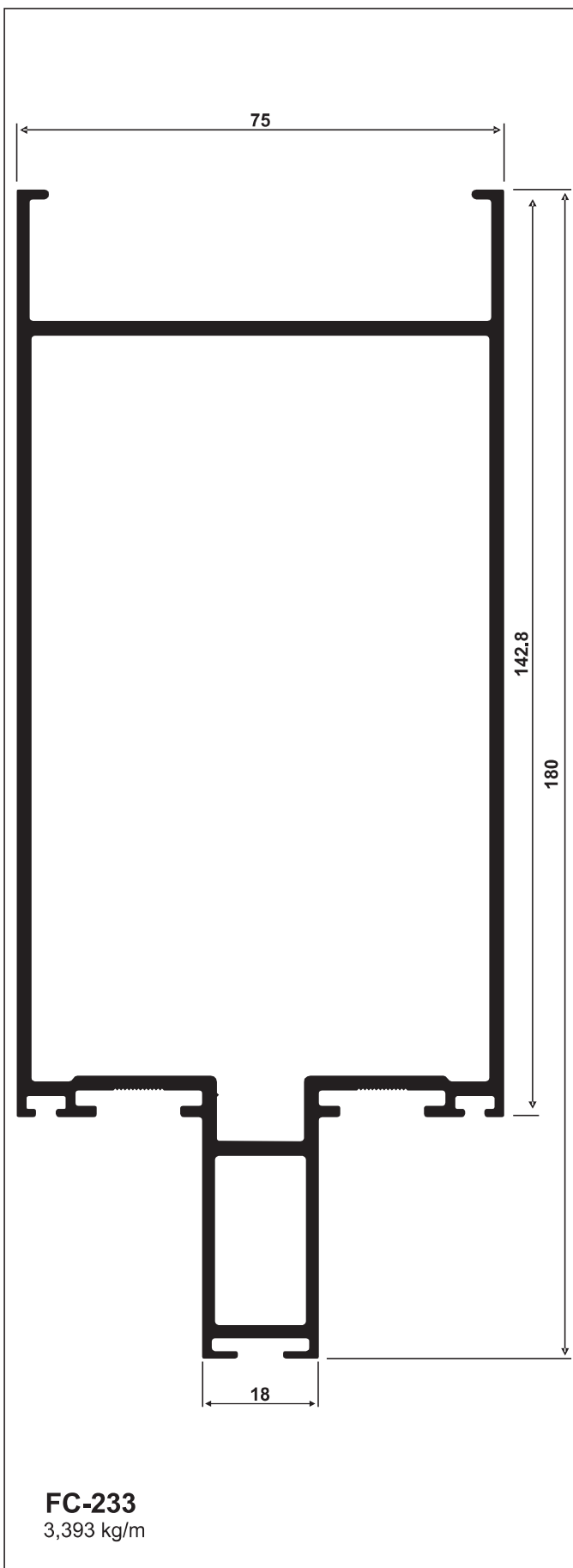

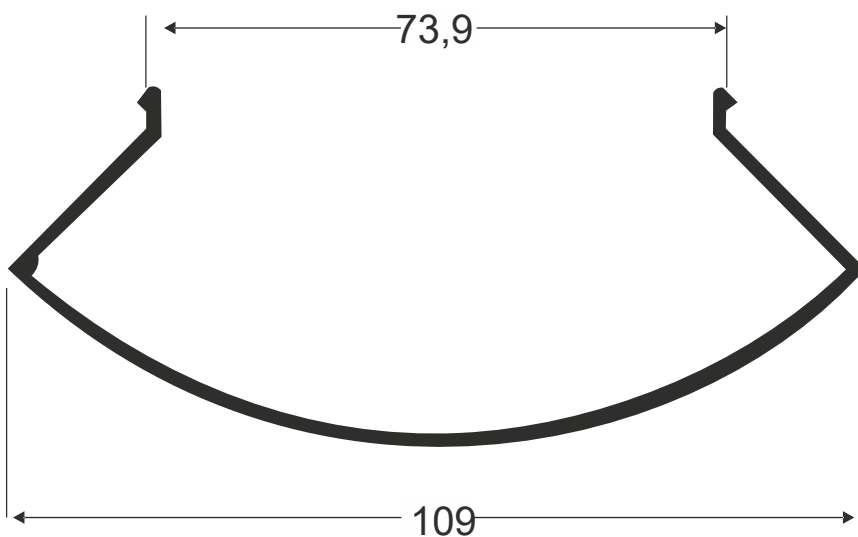

FC-242

0,791kg/m

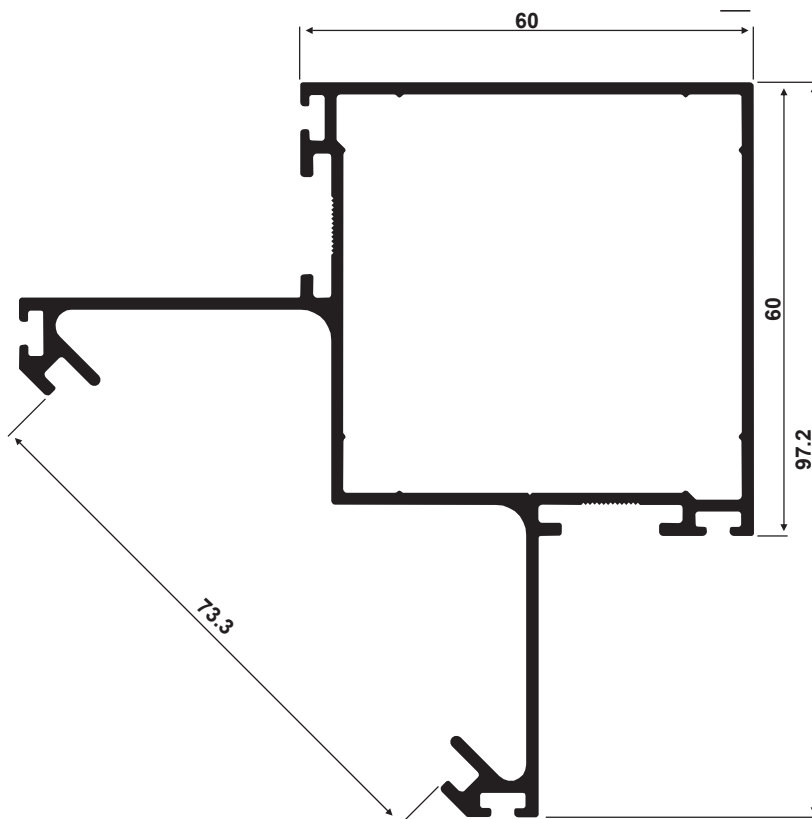

FC-244

1,705kg/m



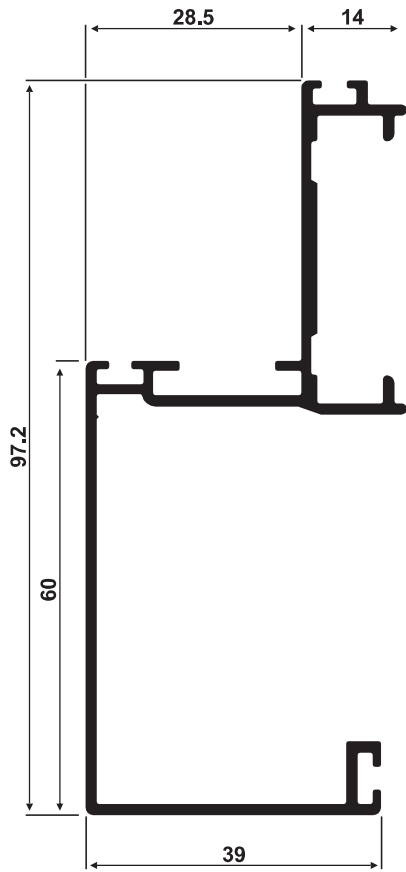

FC-243
1,009 kg/m

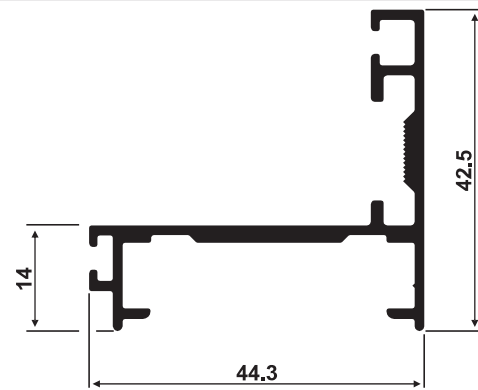

FC-225
0,603 kg/m

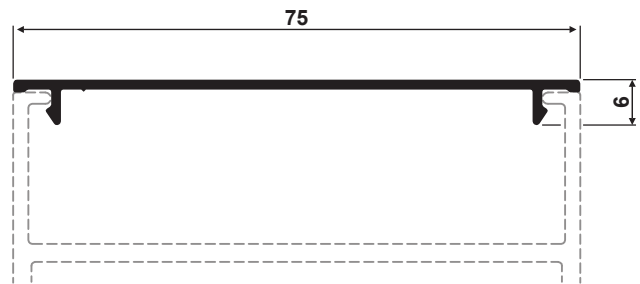

FC-234
0,316kg/m

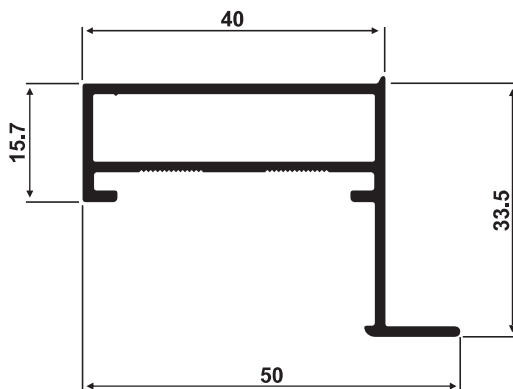

FC-228
0,554 kg/m

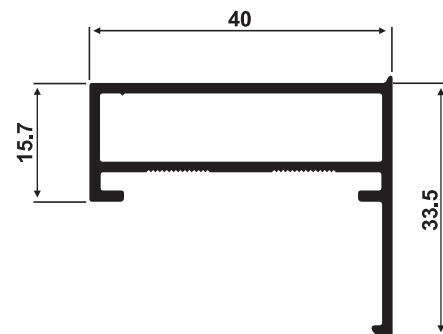

FC-261
0,516 kg/m



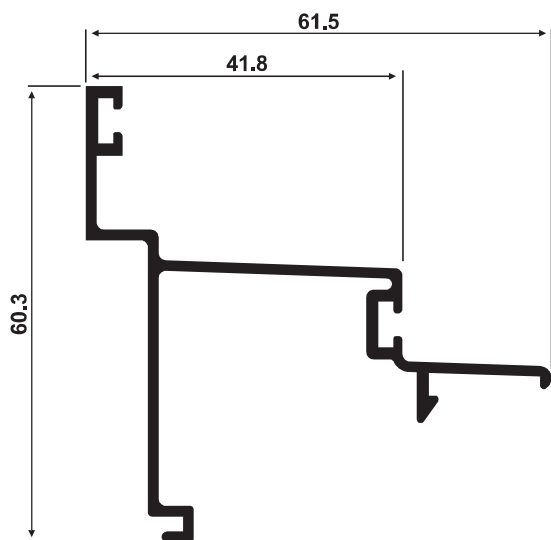

FC-227
0,650 kg/m

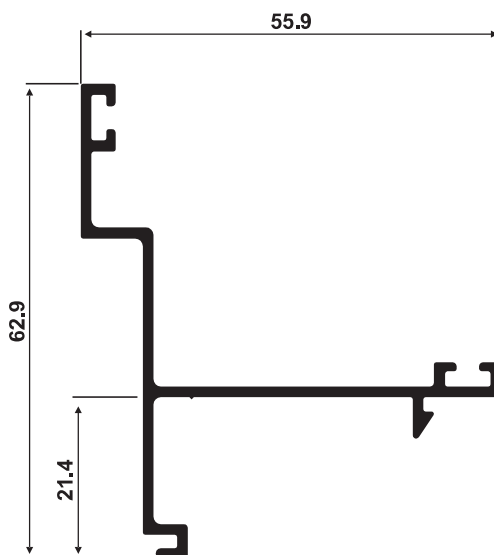

FC-249
0,572 kg/m

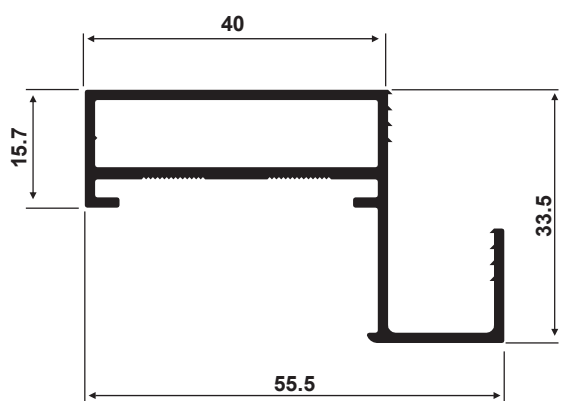

FC-293
0,631 kg/m

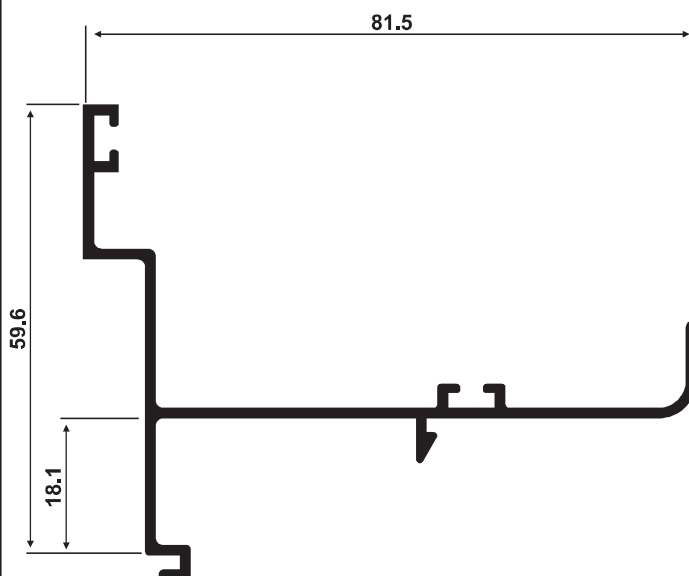

FC-226
0,713 kg/m



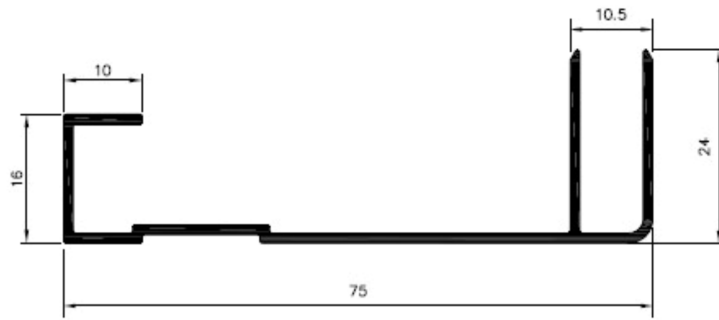

Vista interna com frizo

POR 010

0.468kg/m

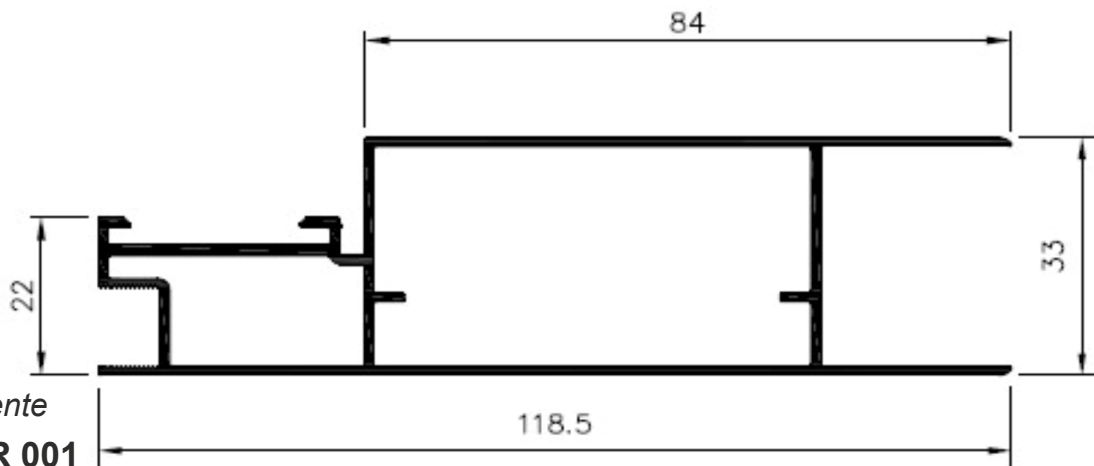

Batente

POR 001

1.140kg/m

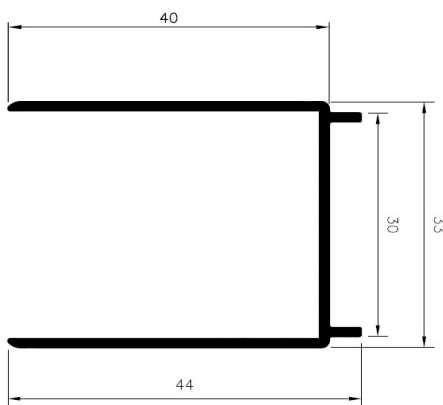

Prolongador

POR 004

0.382kg/m

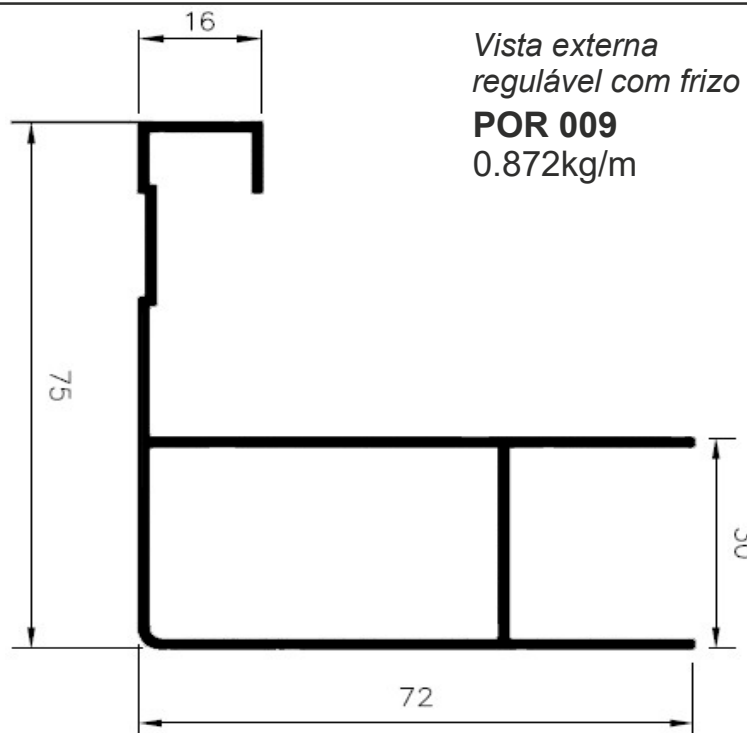

Vista externa
regulável com frizo

POR 009

0.872kg/m

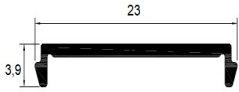
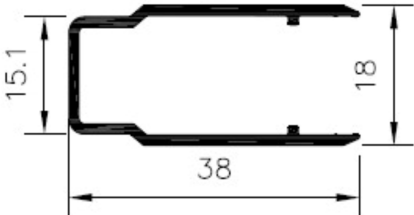

 <p><i>Click de acabamento</i> POR 006 0.084kg/m</p>	 <p><i>Frizo decorativo</i> POR 107 0.315kg/m</p>
--	---

POR-012
0.895kg/m

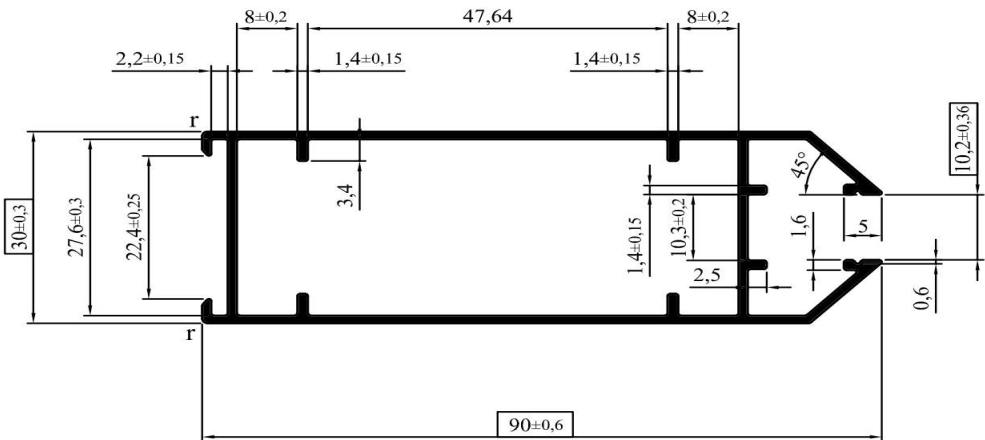

Montante porta
POR 011
1.113kg/m

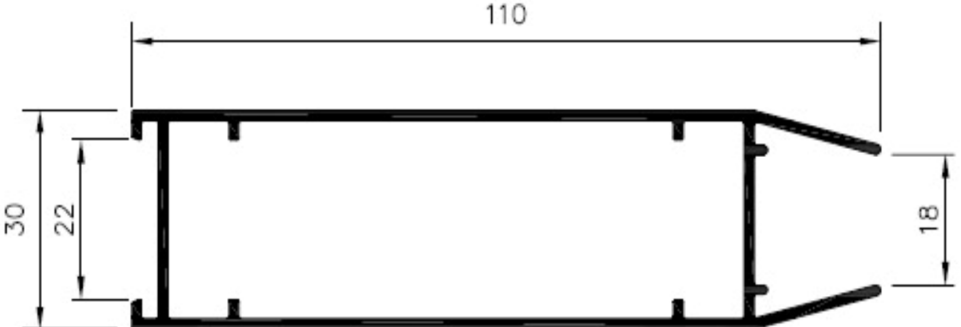

Montante porta grande
POR 005
1.217kg/m

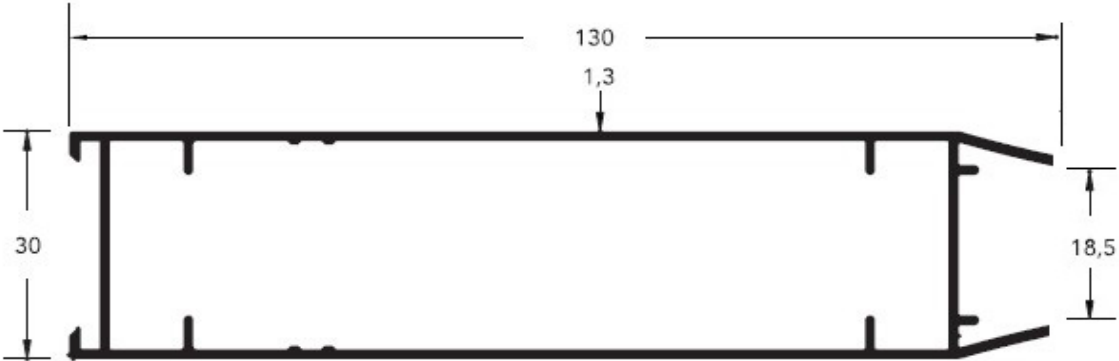

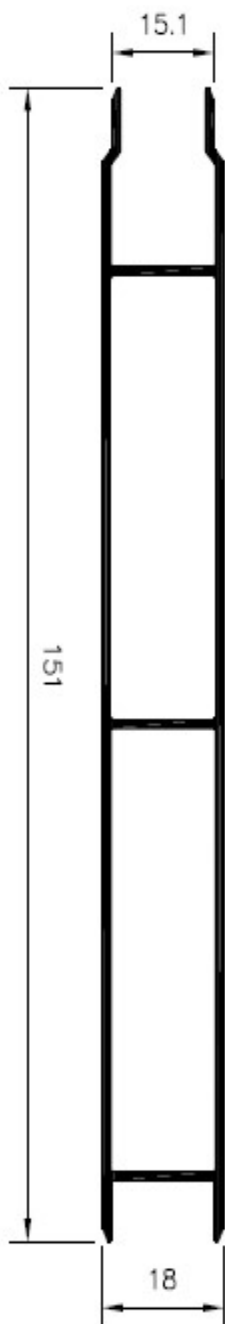

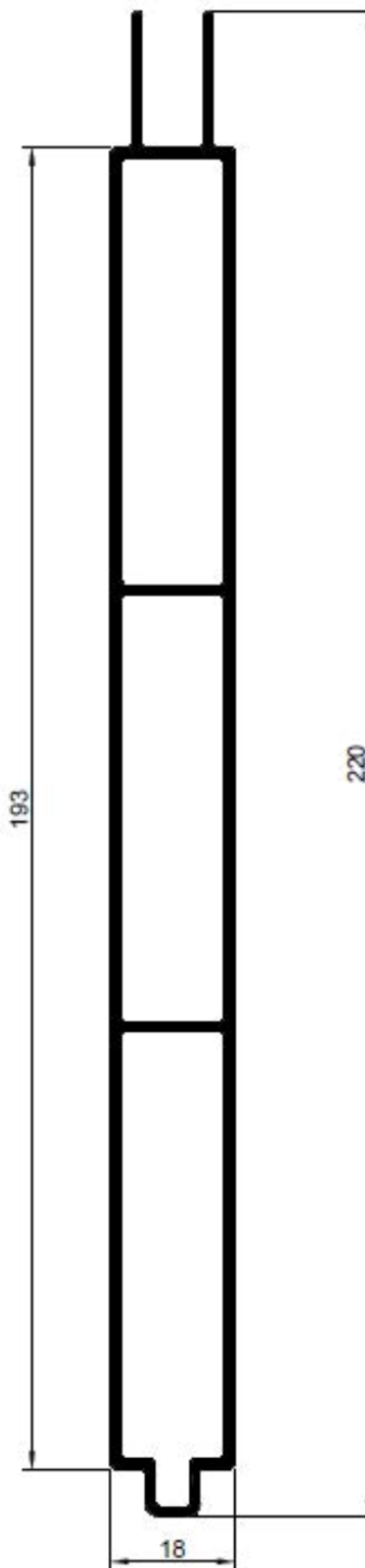

POR 007
1.050kg/m
Lambri



POR-008
1,894 kg/mt

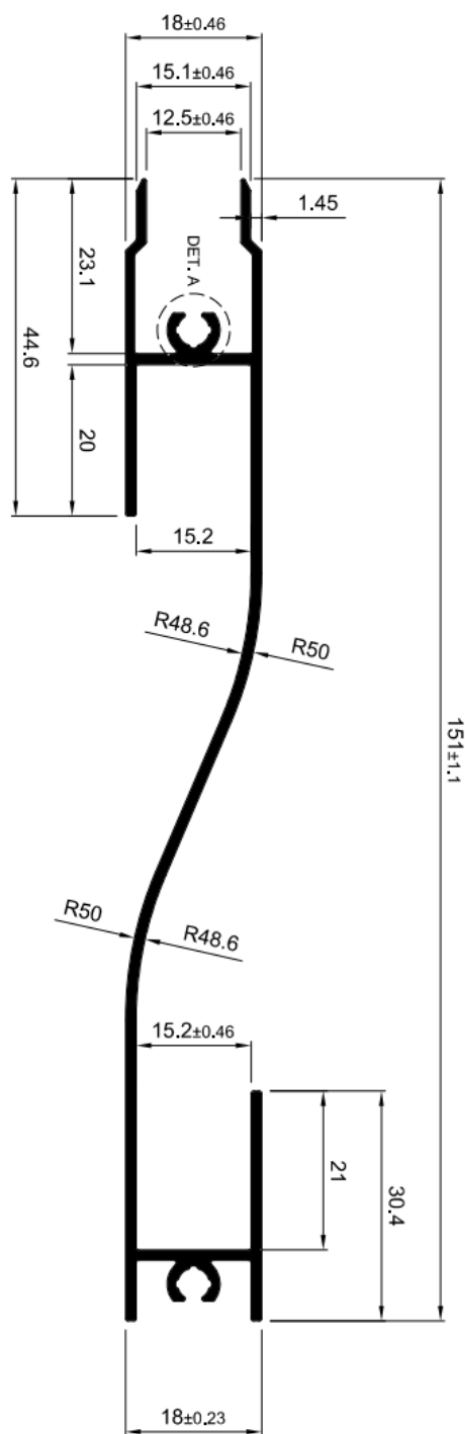



POR-102

1.064kg/m

Perfil Puxador



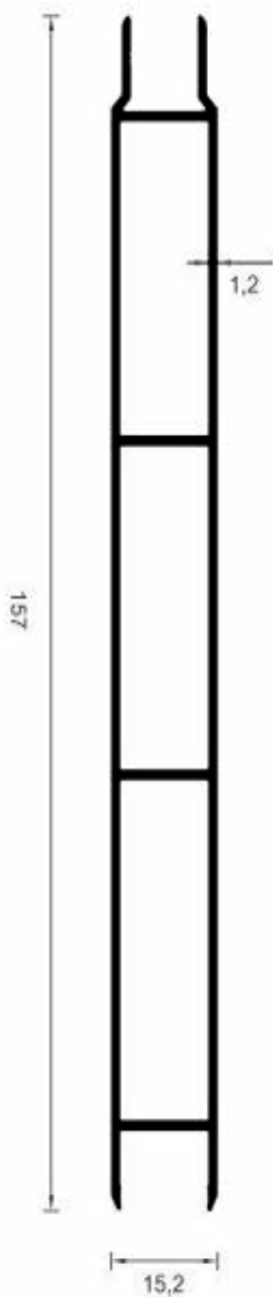

POR-0208
1,201 kg/mt

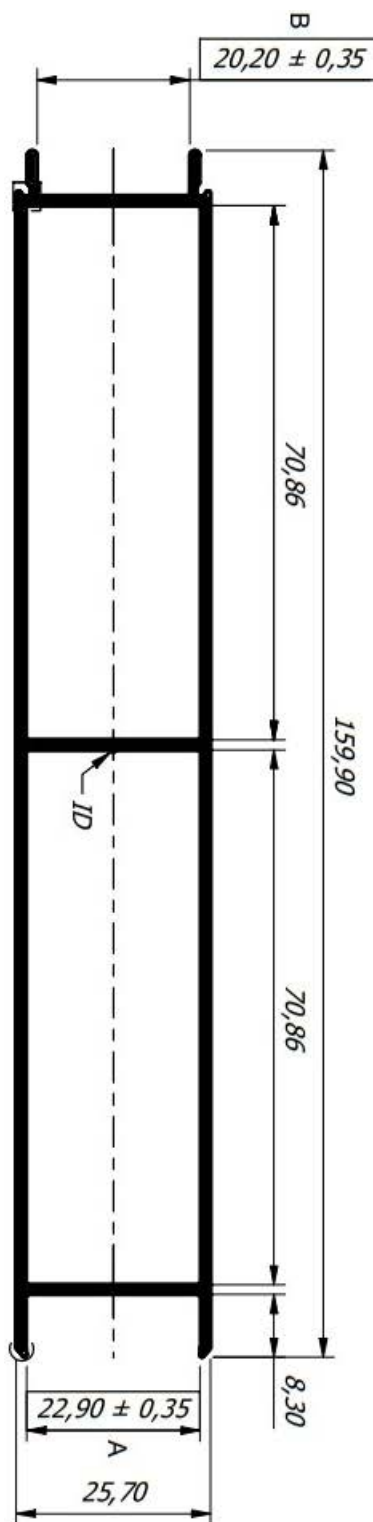

POR-0260
1,362 kg/mt



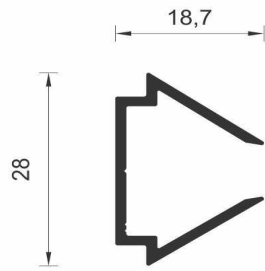

POR-0207
0,248 kg/mt

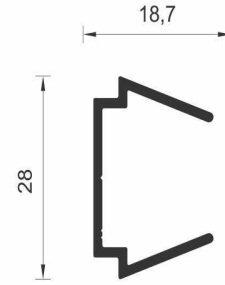

POR-0217
0,238 kg/mt

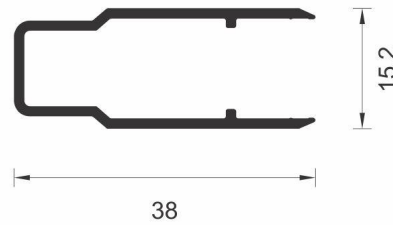

POR-0209
0,305 kg/mt

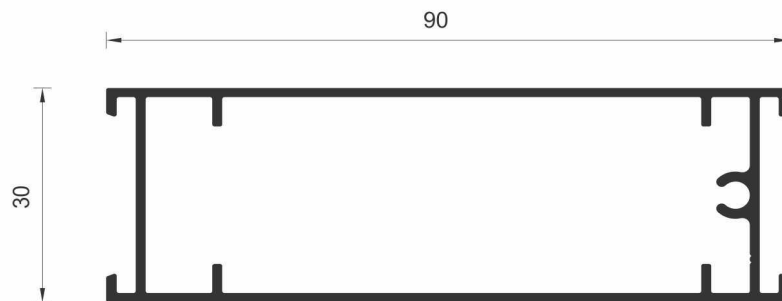

POR-0218
0,962 kg/mt

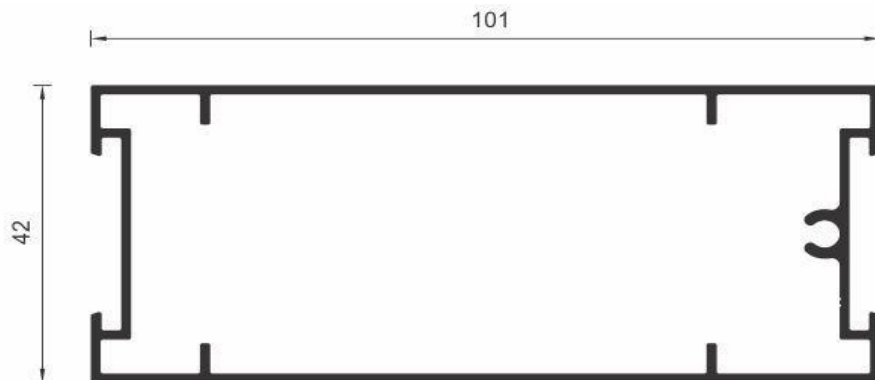

POR-0219
1,186 kg/mt

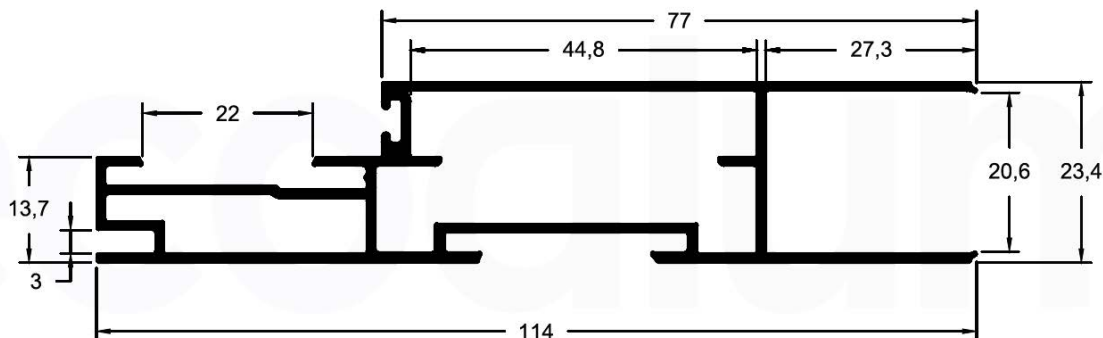

Batente
POR-0240
1,104 kg/mt

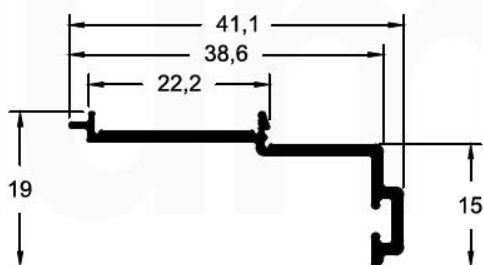

Suporte batente porta pivotante
POR-0252
0,228 kg/mt

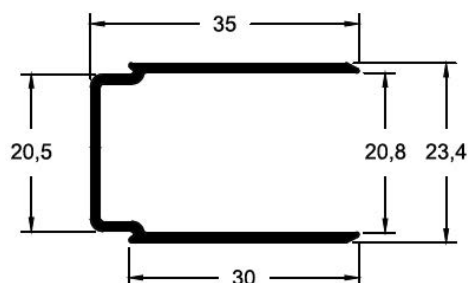

Prolongador batente porta de giro/pivotante
POR-0228
0,312 kg/mt

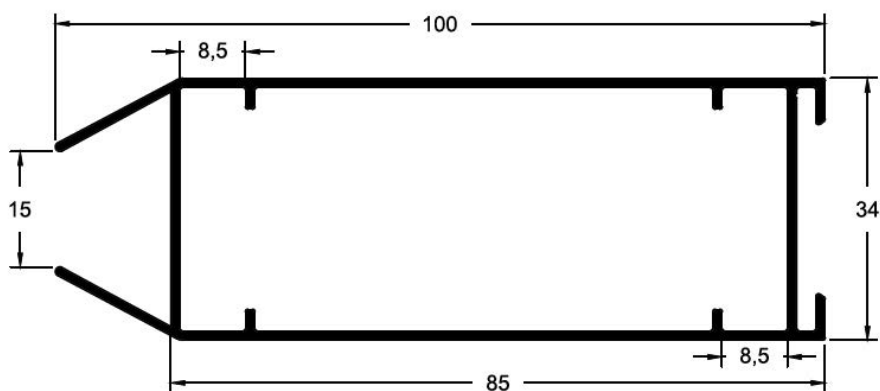

Montante
POR-0234
0,924 kg/mt

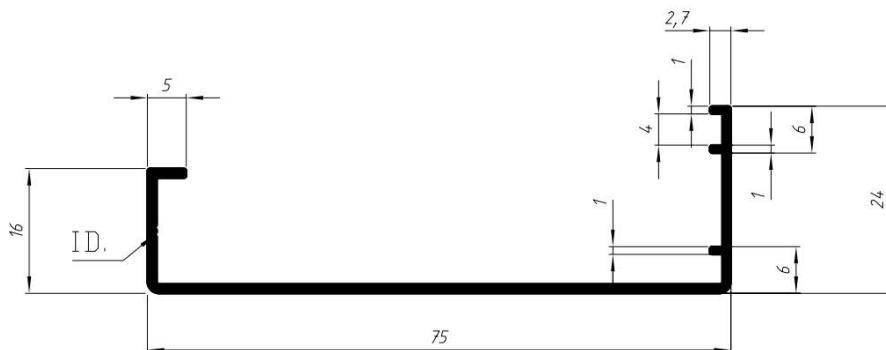

Vista Interna
Porta de giro/pivotante
POR-0241
0,382 kg/mt

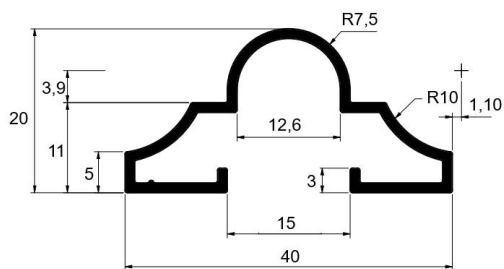

Moldura
POR-0258
0,294 kg/mt

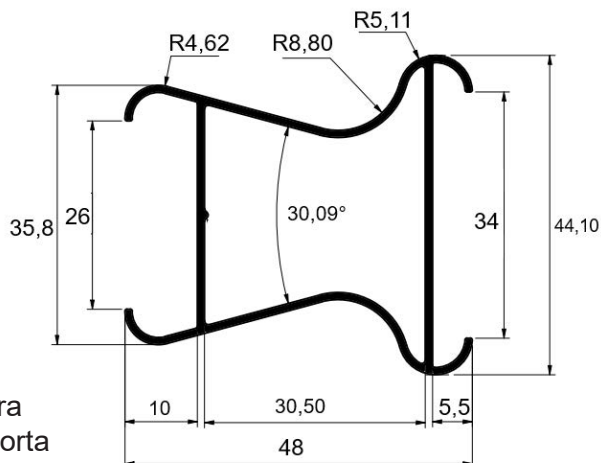

Moldura
para porta
POR-0259
0,511 kg/mt

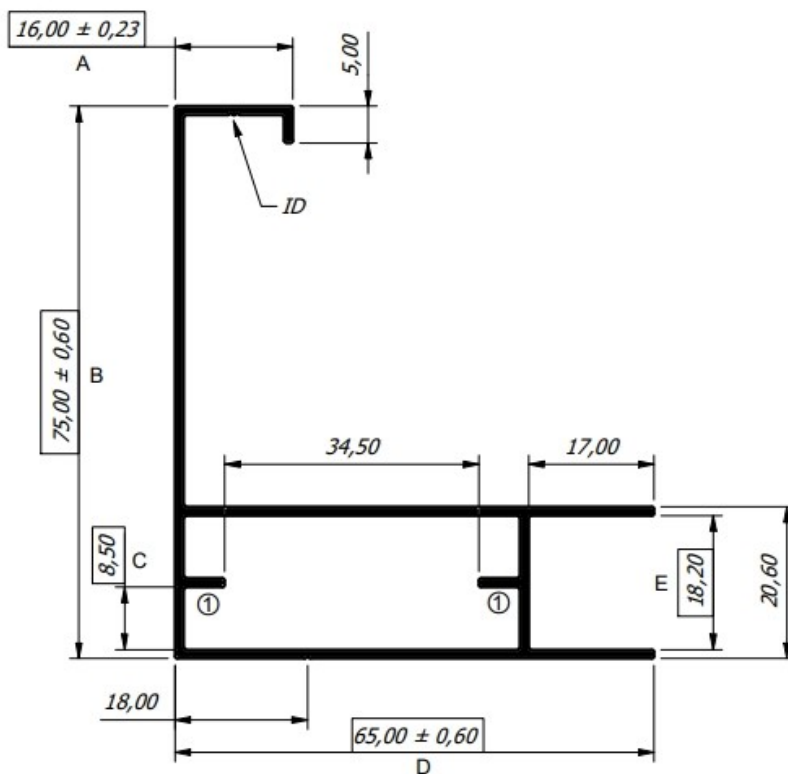

Vista externa
POR-0213
0,811 kg/mt

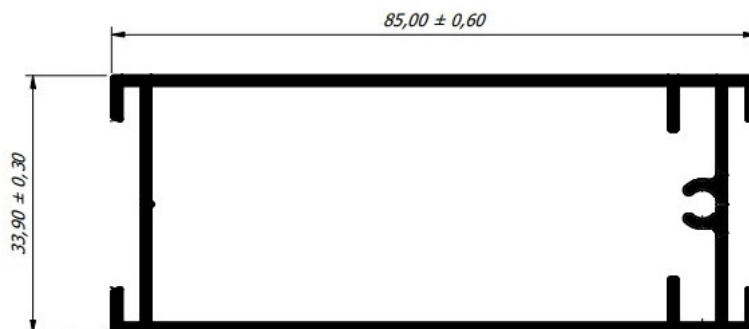

Montante
POR-0263
0,967 kg/mt

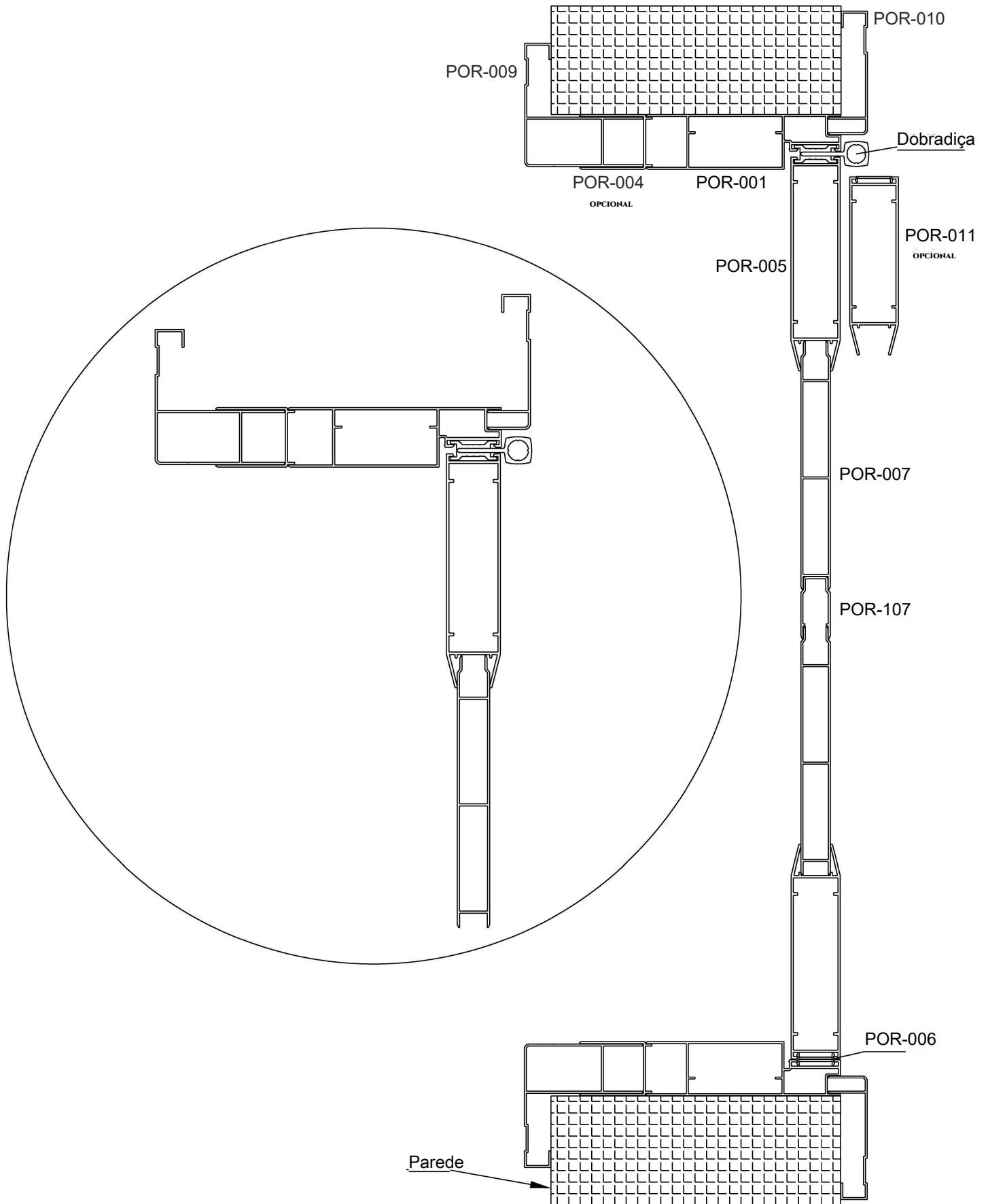

PORTA INTERNA VITRAL SUL

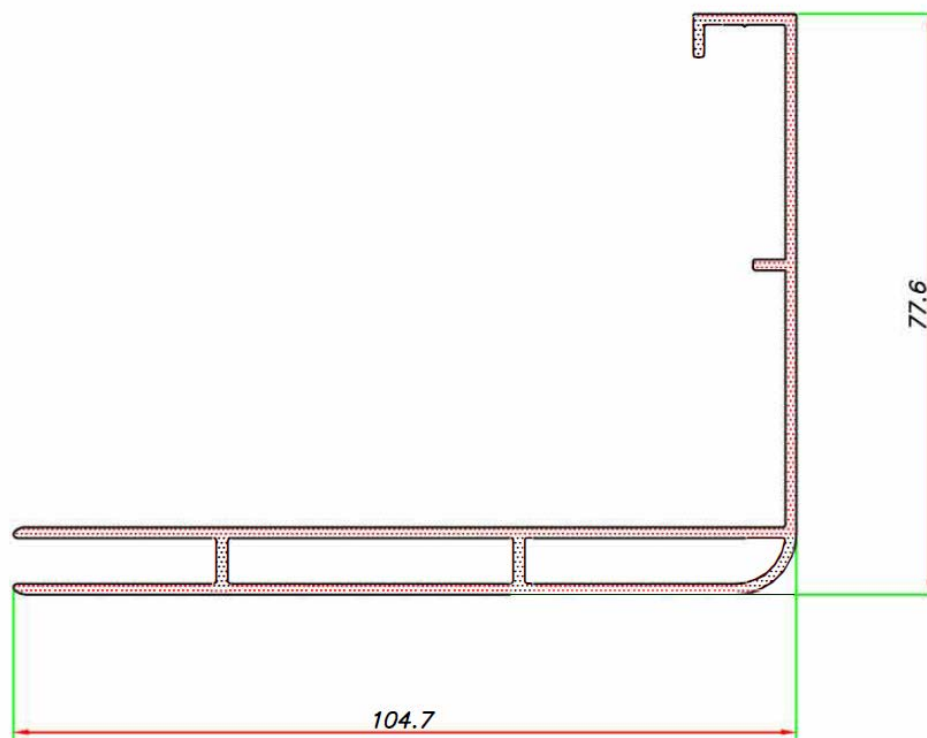

PVI-001
1,238 kg/mt

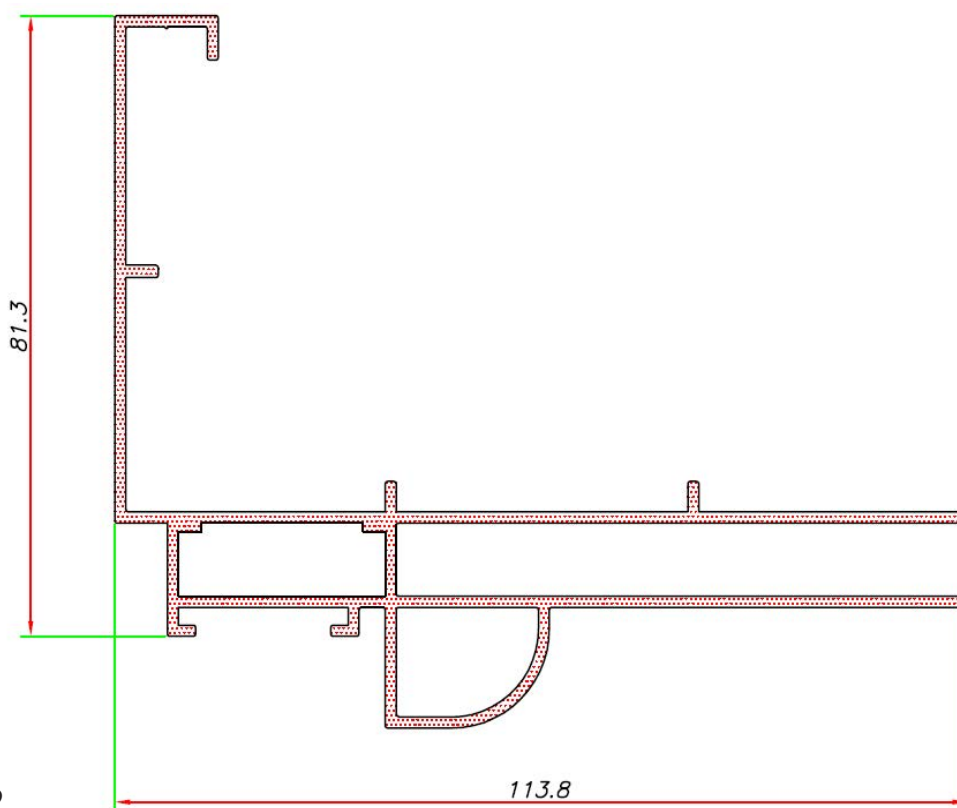

PVI-002
1,556 kg/mt

PORTA INTERNA VITRAL SUL

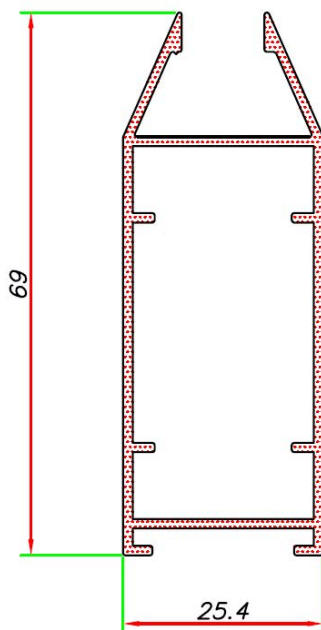

PVI-003
0,669 kg/mt

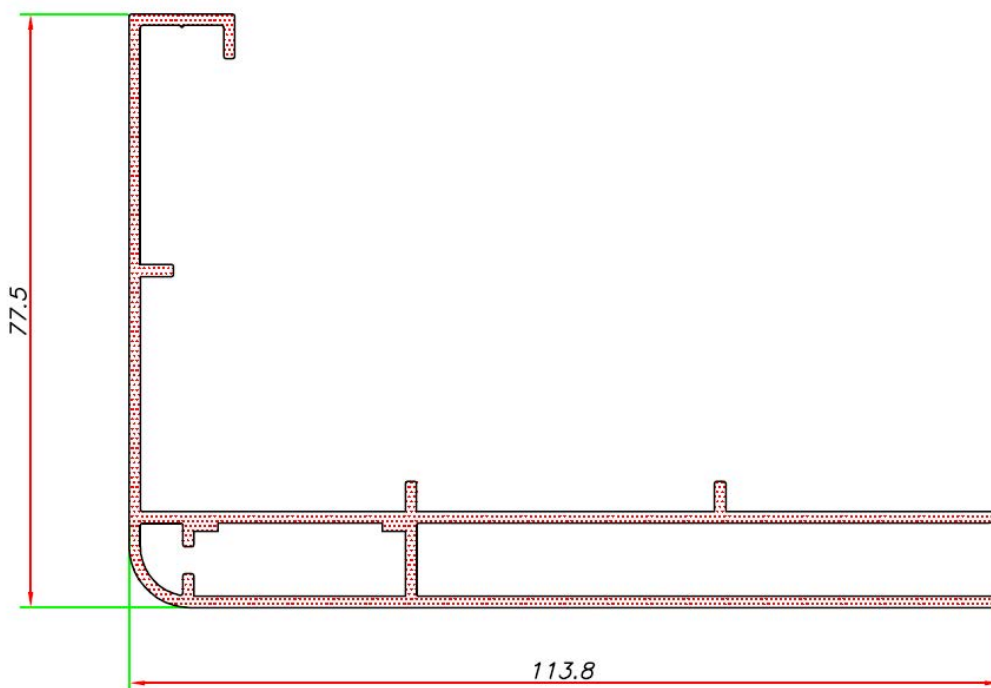

PVI-004
1,369 kg/mt

PORTA INTERNA VITRAL SUL

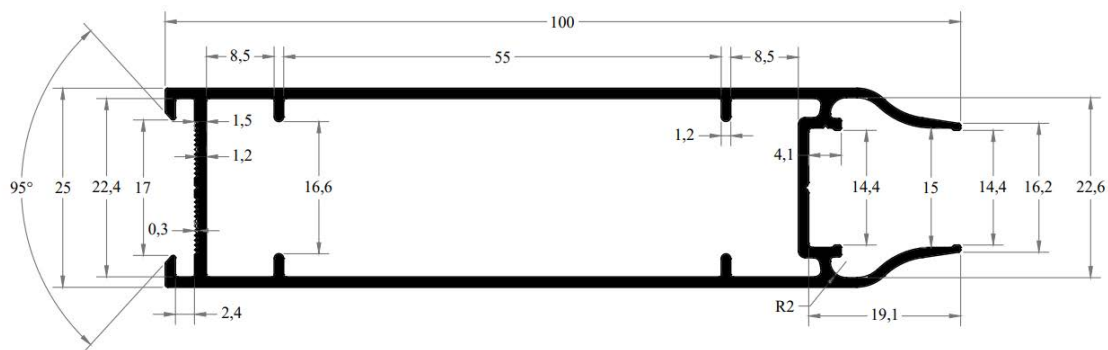

MONTANTE PORTA DE GIRO 100mm

SU-450

0,950 kg/mt

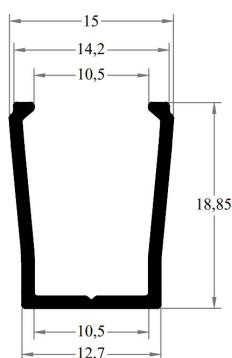

REDUTOR MONTANTE PORTA DE GIRO

SU-438

0,147 kg/mt

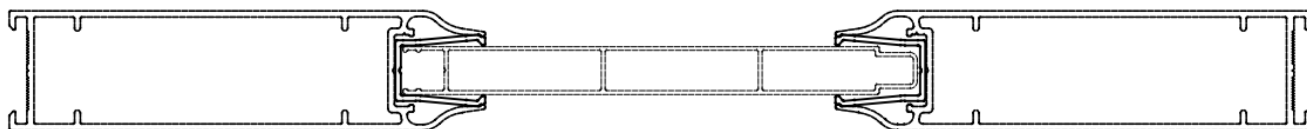

MARCO ENVOLVENTE PARA PORTAS E JANELAS

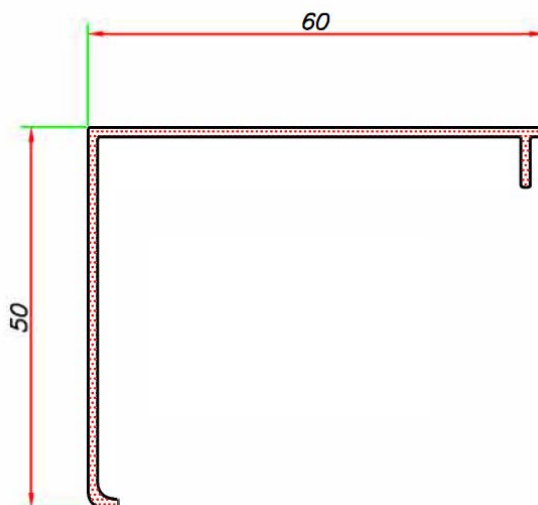

Arremate interno
PVI-005
0.415kg/m

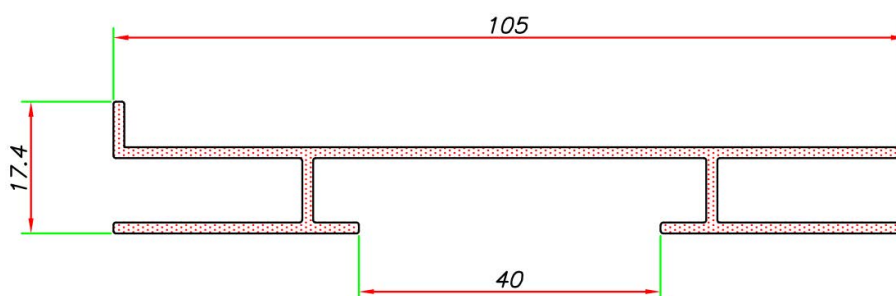

Marco
PVI-006
0.759kg/m

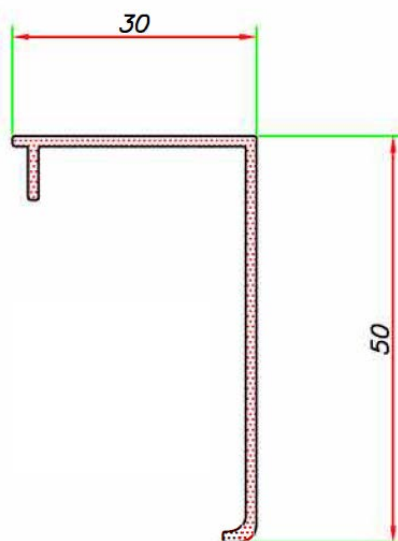

Arremate externo
PVI-007
0.309kg/m



PERFIL PARA PORTA EM ACM

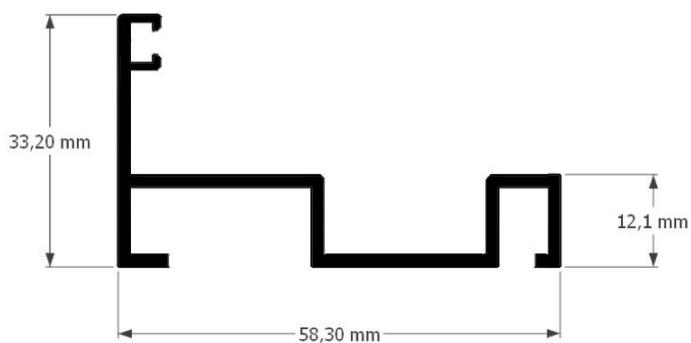

DPL-002

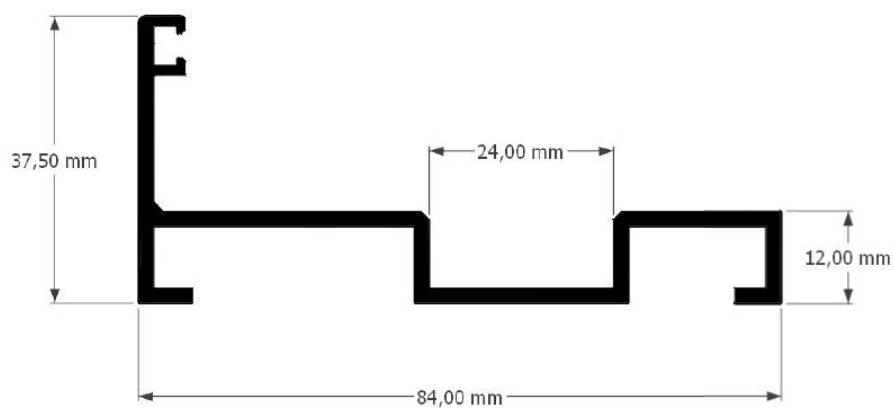

DPL-003



PERFIL PARA PORTA EM ACM

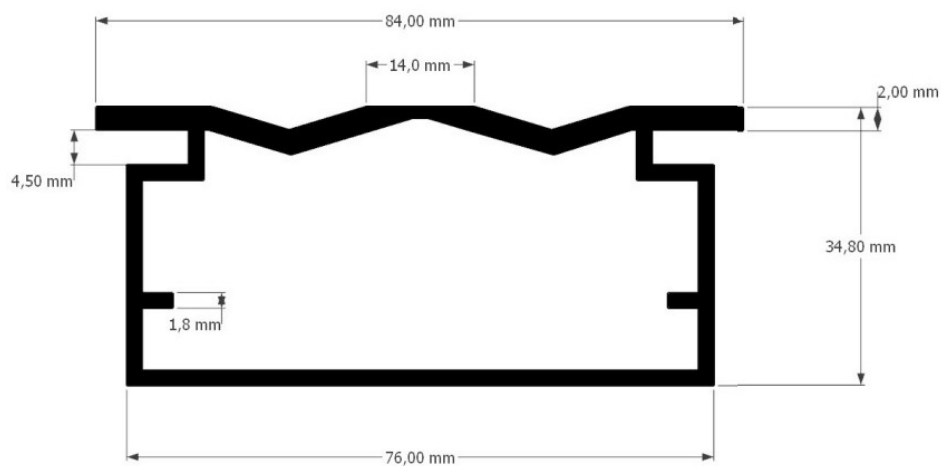

DPL-001

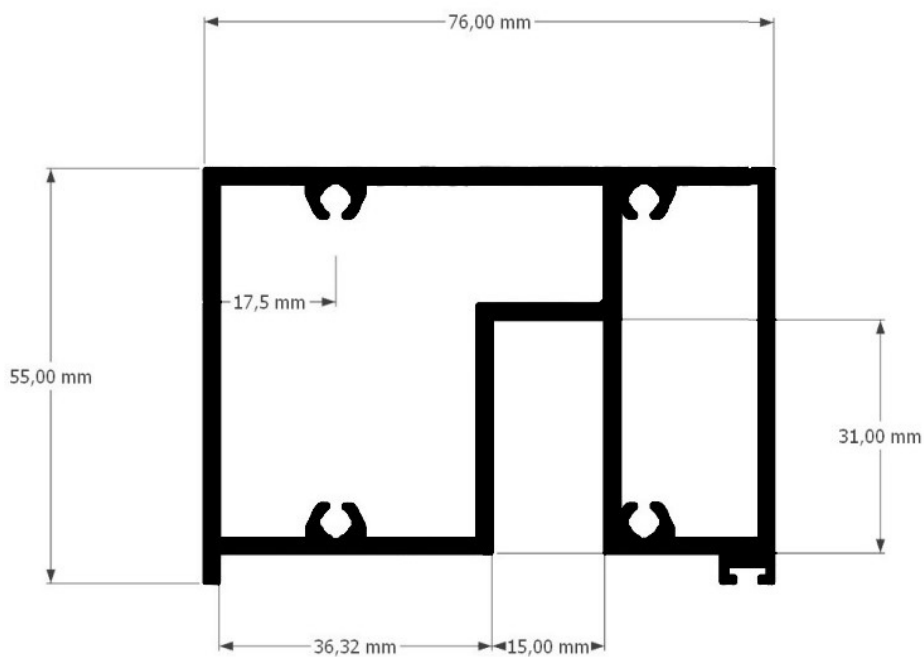

DPL-004



PORTÃO ENROLAR

ALUMÍNIO

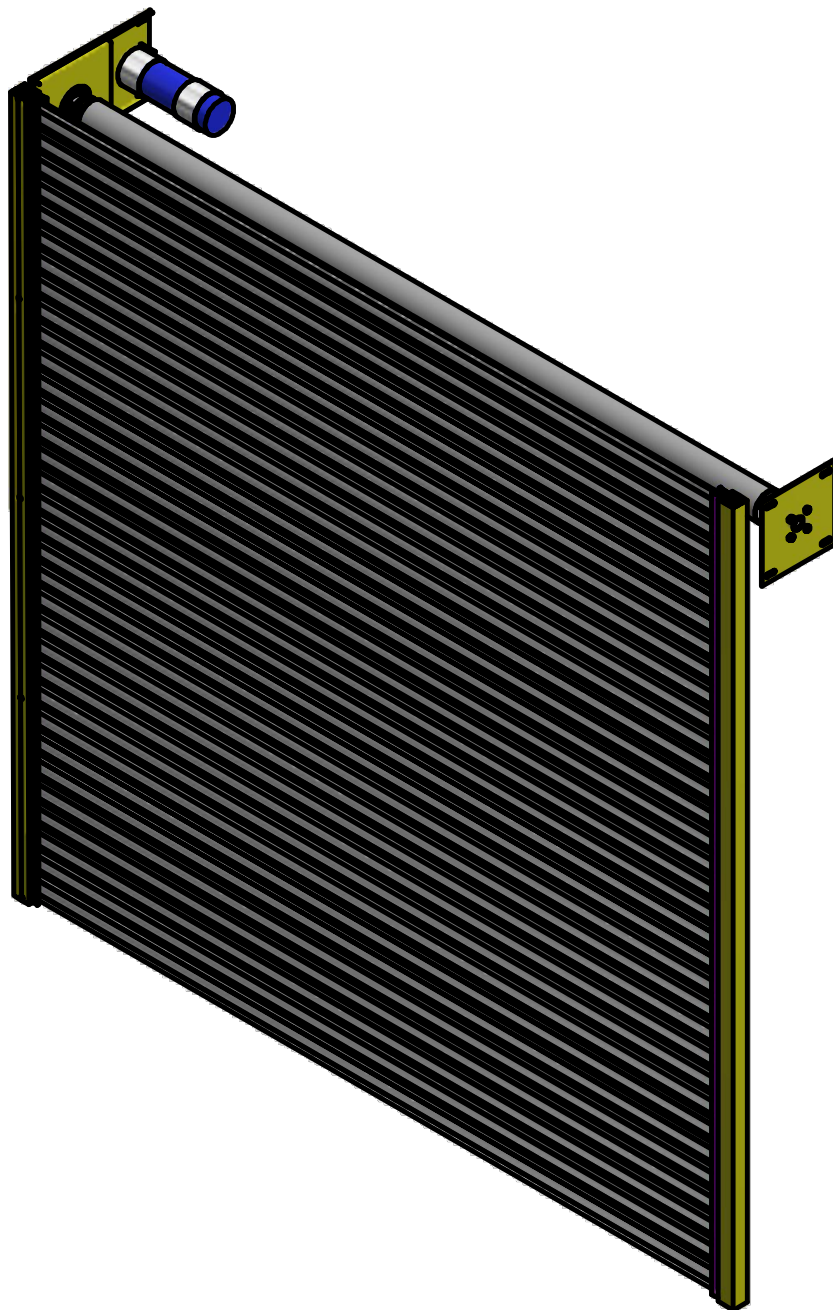

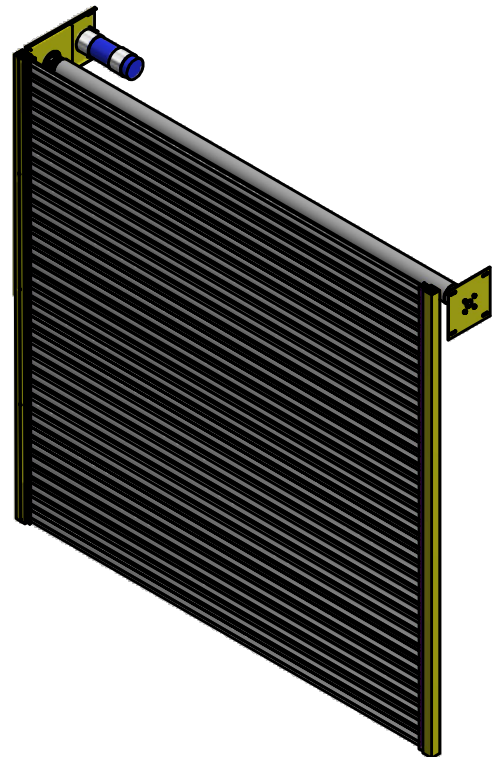
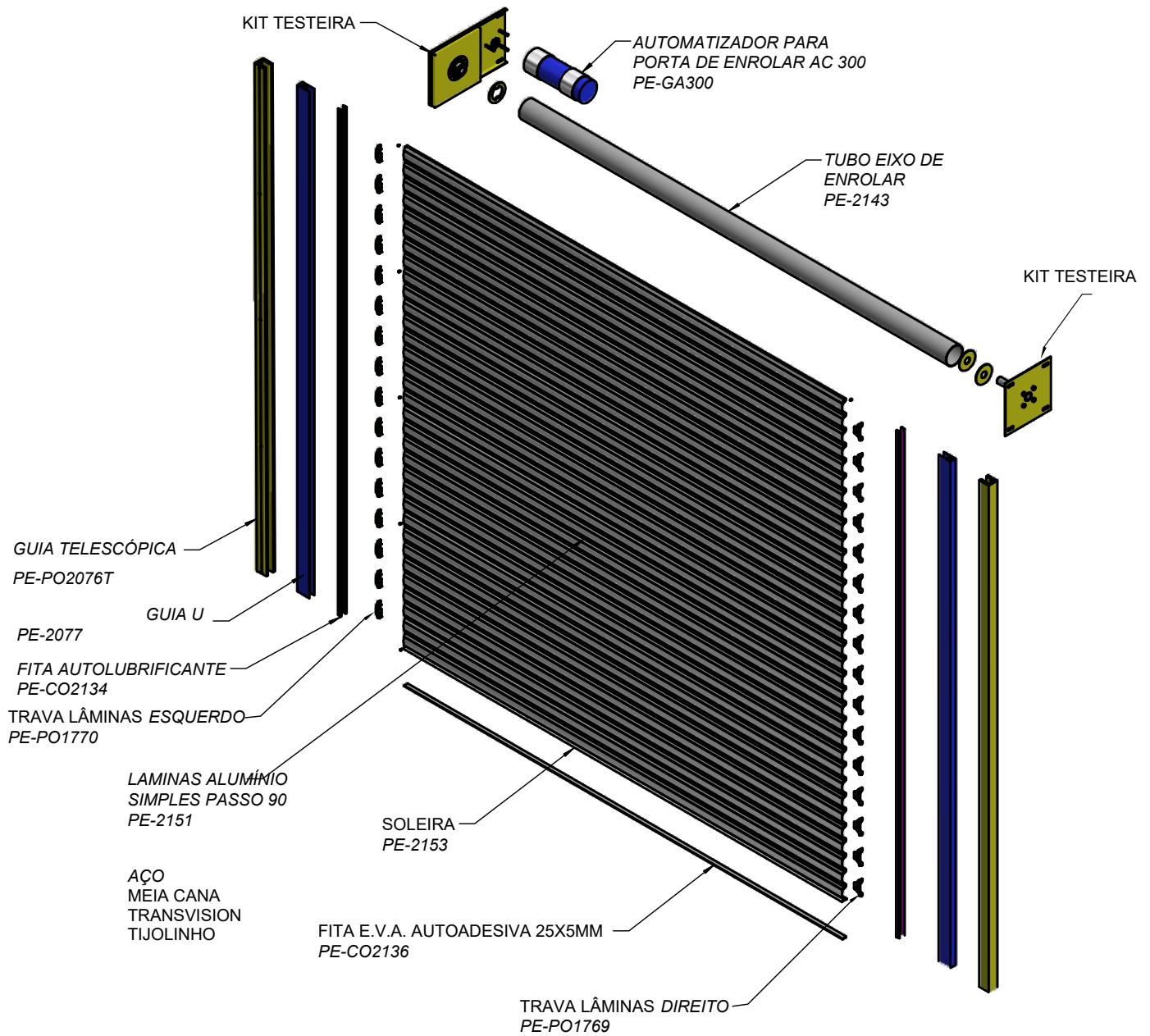

PORTÃO DE ENROLAR

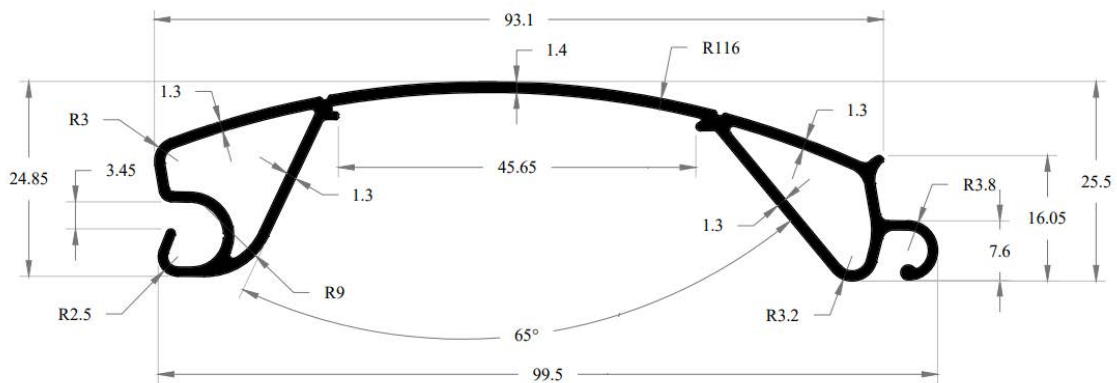

PE-2151

0,766 kg/mt

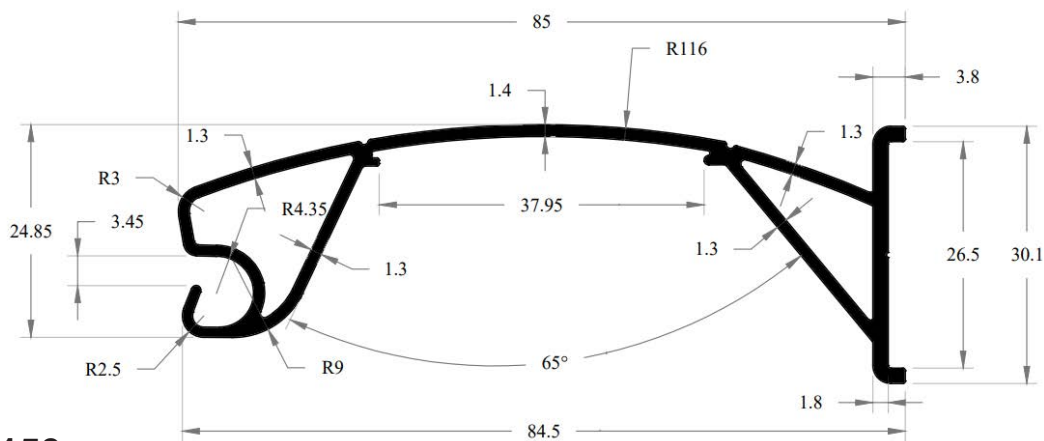

PE-2153

0,779 kg/mt

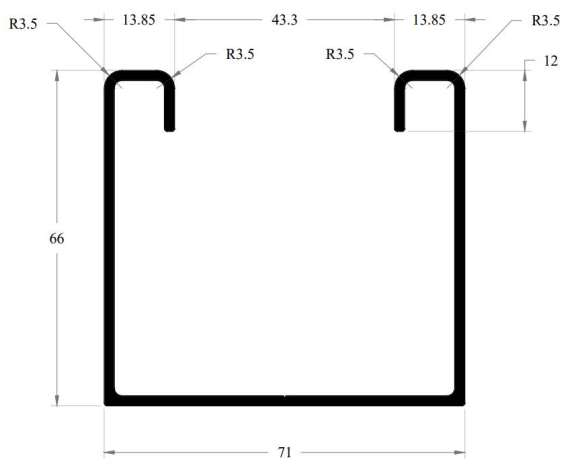

PE-PO2076T

1,298 kg/mt

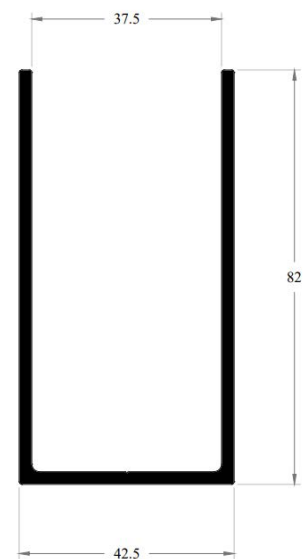

PE-2077

1,371 kg/mt







 (46) 3211-3450

 contato@vitralsul.com.br

 www.vitralsul.com.br

 Rod. Vitório Traiano, 471 - Bairro Água Branca
Francisco Beltrão/PR - CEP 85601-838

SAIBA MAIS



Esconeio o QR Code